

THE SITE BOOK

Revised 2007 Edition

Foreword

The **SITE BOOK** is an invaluable step-by-step installation guide for British Gypsum systems. It should be used by site personnel regularly involved in either building or supervising systems installation. The sequence photographs and guidance notes depict the basic steps required for trouble-free fixing. In practice, consideration must be given to design criteria requiring specific project solutions. Installation shots are indicative only - it is important that good practice is always followed on site including taking all necessary safety precautions and wearing appropriate personal protection equipment.

1	General site guidance	6	11	Quantity take-off details	488
2	Manual handling and lifting	38	12	Products	508
3	Technical support and product training	52		Boards	508
4	SpecSure®	60		Plasterboard accessories	526
5	Installation - Partition and wall systems	62		Fixings	538
6	Installation - Wall lining systems	240		Metal components	546
7	Installation - Floor, ceiling and soffit systems	290		Insulation	566
8	Installation - Steelwork encasement systems	382		Plasters and plaster accessories	582
9	Plaster systems	408		Access panels	600
10	Finishing systems and decorative effects	428		Ceilings (<i>reference only</i>)	608
	Plaster skimming	428		Decorative products	614
	Jointing	436	13	Glossary	628
	Tiling	450	14	Index	640
	Decorative effects - Trims, Cove and Cornice	472			

For further details on all British Gypsum systems and products visit www.british-gypsum.com



5	Installation - Partition and wall systems	62
a20 (inc. a15)	GypWall CLASSIC and GypWall ROBUST - the definitive metal stud partition system	62
	GypWall EXTREME - ultimate impact and abrasion resistant partition system	86
a20.1	GypWall CURVE - curved partition system	110
a13	GypWall RAPID dB Plus - metal stud housing partition system	118
a21	GypWall QUIET - acoustic separating wall system	136
	GypWall QUIET IWL - independent twin-frame acoustic separating wall system	146
a24	GypWall QUIET SF - single frame acoustic separating wall system	156
a23	GypWall STAGGERED - staggered stud acoustic partition system	166
a32	GypWall AUDIO - the ultimate sound insulating wall system	180
a30	ShaftWall - shaft and duct encasement system	190
a25 & a26	Specialist systems (GypWall SECURE and BlastWall) <i>(reference only)</i>	216
a35	FireWall - High performance fire-resistant wall system	218
a60	Timber stud - timber frame partitions and walls with single or twin frames	226
6	Installation - Wall lining systems	240
b10	DriLyner BASIC, TL, SI, RF, MF - drywall masonry lining systems	240
b22	GypLyner UNIVERSAL - metal framed wall lining system	260
b21	GypLyner IWL - independent wall lining system	276
b35	FlameLyner - industrial fire-resistant lining system <i>(reference only)</i>	288

7	Installation - Floor, ceiling and soffit systems	290
c10	CasoLine MF - concealed grid MF suspended ceiling system	290
c10.1	CasoLine CURVE - concealed grid MF curved ceiling system	306
c15	GypLyner UNIVERSAL - concealed grid ceiling lining system	318
c12	CasoLine GRID - suspended grid ceiling system (<i>reference only</i>)	330
c60	Timber joist - ceiling and separating / compartment floors	332
c20	GypFloor SILENT - sound insulating floor system	348
	GypFloor SB - floating floor treatment for separating floors	362
c55	SoffitLine - thermal lining system for semi-exposed soffits	374
8	Installation - Steelwork encasement systems	382
d12	FireCase - frameless structural steel encasement system	382
d15	GypLyner ENCASE - GypLyner framed structural steel encasement system	396
9	Plaster systems	408
b05	Plaster systems	408

1

General site guidance	7
Health and Safety	8
Board fixing	11
Good practice detailing	15
Fixings into drywall systems	21
Services installations	26

General site guidance

At British Gypsum, we recognise the importance of following good site practice at all times. In this section we detail general site guidance outlining safe practice for handling and storing British Gypsum products and systems, helping you to work better and stay safe.

These notes are for guidance purposes only and are not intended to be exhaustive.

We advise that you read and familiarise yourself with all of the relevant information in this book prior to commencement of work.

Where other manufacturers' products or systems are being used in association with British Gypsum systems, reference should always be made to the manufacturer's own installation instructions and product data.



Health and Safety

IMPORTANT:

Please read the following notes before specifying, handling or installing British Gypsum products. The notes are for guidance purposes and are not intended to be exhaustive. When installing proprietary products, such as fixing devices, reference should be made to the manufacturers' instructions and product data.

General

The details and guidance contained in the **SITE BOOK** have been written for the benefit of experienced trade professionals, to assist them in the use and installation of British Gypsum products. The book assumes a level of knowledge which makes it unsuitable for use by a novice without the benefit of other instruction as to the use and installation of British Gypsum products. British Gypsum provides training on the use and installation of all its products at the Company's Drywall Academy Training Centres.

The advice and guidance referred to does not seek to replace the Health and Safety advice and systems of employers in relation to the use and installation of the Company's products but should be considered in addition. At all times all users of such products and installation techniques should ensure that they are familiar with, and adhere to, their employer's own Health and Safety procedures.

Whilst the advice and guidance given in the **SITE BOOK** meets relevant legislative and regulatory requirements and standards current at the date of publication, it is the responsibility of the user to ensure that these remain current prior to use.

The British Gypsum products and systems included in the **SITE BOOK** have been developed for use in domestic, commercial and industrial buildings. Guidance as to the correct installation and use of these products and systems is included in the installation sections.

It is important to follow good site practice at all times and to ensure that appropriate safety precautions are taken (including the wearing of appropriate personal protection equipment and clothing) when working with British Gypsum products.

The following general notes are offered for guidance:

- British Gypsum systems are non-loadbearing and are not designed to support body weight. Fixers must work from an independent support system.
- Manual off-loading of boards, panels and bagged materials should be carried out with care to avoid unnecessary strain.
- Keep sanding and other dust generation to a minimum. Maintain adequate ventilation and/or wear suitable protection.
- When cutting boards or metal sections, hand and power tools should be used with care keeping blades and saw teeth clear of hands, etc.
- Power tools should be used in accordance with manufacturers' recommendations, and only be used by people who have been instructed and trained to use them safely.

- When using powdered products, mix with water in well ventilated conditions. Avoid contact with eyes and skin – wear suitable eye and skin protection. In the event of contact with the eyes, irrigate with plenty of clean water immediately.
- When handling insulation or cutting board products containing glass fibre, wear suitable face and skin protection. Wear eye protection when working overhead.

NB Suitable protection should be to the following standards:-

- Face masks to *EN 149 FFP2*.
- Eye protection to *BS EN 166*.

Further information is available in Product Data Sheets (giving safety, handling and storage details) for all British Gypsum products, which are available on request from the British Gypsum Drywall Academy Advice Centre or are available to download from www.british-gypsum.com

Customers are also reminded that under the Health and Safety at Work Act 1974, and the following subsequent regulations, employers are under a duty to ensure that all risks associated with the use of equipment are properly risk assessed, that employees are informed of the findings of these assessments and are instructed, trained and supervised in the proper use of such work equipment and protective equipment. The extent of instruction, training and supervision required will depend on the employees existing competence necessary to use the work equipment with due regard for Health and Safety.

- Management of Health and Safety at Work Regulations
- Provision and Use of Work Equipment Regulations
- Personal Protective Equipment Regulations

Handling and storage

British Gypsum fully accepts its responsibilities as a supplier of building materials and systems as required by Section 6 of the Health and Safety at Work Act 1974.

However, in designing and installing systems incorporating British Gypsum products, full consideration must be taken of the legal requirements of:

- 1 Manual Handling Operations Regulations.
- 2 Construction (Design and Management) Regulations.
- 3 Control of Substances Hazardous to Health Regulations (COSHH).

Guidance documents / approved codes of practice regarding these regulations are available via the Health and Safety Executive.

Board fixing

General

- Fix boards with decorative side out to receive joint treatment or a skim plaster finish.
- Lightly butt boards together. Never force boards into position.
- Install fixings not closer than 13mm from cut edges and 10mm from bound edges.
- Position cut edges to internal angles whenever possible, removing paper burrs with fine sandpaper.
- Stagger horizontal and vertical board joints between layers by a minimum of 600mm.
- Locate boards to the centre line of framing where this supports board edges or ends.

NB Gyproc plasterboards should not be considered as a means of isolating dampness or used in areas subject to persistently damp or humid conditions.

Screw fixing to Gypframe metal framing

- Select Gyproc screws to give a nominal 10mm penetration into the metal. See **Table 1**.

- Where autofeed power screwdrivers are employed, use Gyproc Drywall Collated Screws (supplied in strips).
- Use Gyproc Drywall Screws for fixing Gypframe 'C' Studs and associated framing up to and including 0.7mm gauge (e.g. 70 S 60), and for fixing to Gypframe 'I' Studs up to and including 0.5mm gauge (e.g. 70 I 50).
- Use Gyproc Jack-Point Screws for fixing Gypframe 'C' Studs and associated framing 0.8mm gauge or greater (e.g. 92 S 10), and for fixing to Gypframe 'I' Studs 0.7mm gauge or greater (e.g. 70 I 70).

NB Understanding the codes for metal studs and channels. The first 2 or 3 digits refer to the component width, the letter/s refer to the component type, and the last two numbers indicate the metal thickness in mm, e.g. **92 S 10** refers to **92mm wide 'C' Stud**, metal thickness of **1.0mm**.

- Use Gyproc Wafer Head Drywall Screws for fixing Gypframe metal to metal. Their thin head minimises the risk of subsequent bulging of the lining board over fixings.
- Use Gyproc Wafer Head Jack-Point Screws for fixing Gypframe metal to metal where one or both of the sections is between 0.8mm and 2mm thick. Always fix 'thin' to 'thick' so that the thin metal is trapped between the 'thick' metal and the screw head.

Table 1 - Fixing to metal sections

Lining board thickness mm	Gyproc Drywall Screw length mm	Gyproc Jack-Point Screw length mm
6	22	–
9.5	25	–
10	25	–
12.5	22 [†]	–
12.5 or 2nd layer of 6 over 6	25	25
15	25	25
19	32	35
2nd layer of 12.5 over 12.5	36	35
2nd layer of 15 over 15	42	41
2nd layer of 12.5 over 19	42	41
3rd layer of 12.5 over 2 layers of 12.5	50	60
[†] Gypframe RB2 SureFix Bar and DriLyner MF		
Thermal laminates thickness mm	Gyproc Drywall Screw length mm	
22	32	
27, 30	42	
35	50	
40	50	
48, 50	60	
60	75	

Fixing to timber supports

Select the correct length of fixing, see Table 2.

- Use Gyproc Drywall Timber Screws when fixing to standard softwood, super-dried timber and engineered 'I' beams. They provide a superior fixing to nails and minimise the risk of fixing defects occurring.
- Where autofeed power screwdrivers are employed, use Gyproc Collated Drywall Timber Screws (supplied in strips).
- Drive fixings firmly home without fracturing the board surface but leaving a shallow depression to facilitate spotting.
- Adhere to the fixing tolerances shown in **Figure 1**. If the timber support has insufficient bearing surface, fix a further timber support to it as shown in **Figure 2**. Alternatively, in the case of joists or trusses, use suitable counter battens.

Table 2 - Fixing to timber sections

Board mm	Gyproc Drywall Timber Screws thickness to fix board for direct decoration or plastering mm
9.5	32
12.5	38
15	38
19	41
12.5 over 12.5	51
15 over 15	60
12.5 over 19	60
15 over 19	60

Figures

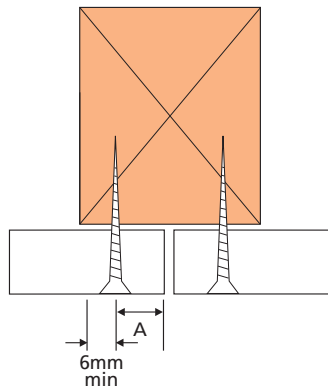

Fixing tolerances

Lightly butt boards with a max. separation of 3mm. Where a cut edge occurs dimension A is 13mm min; where a bound edge occurs

1 dimension A is 10mm min.

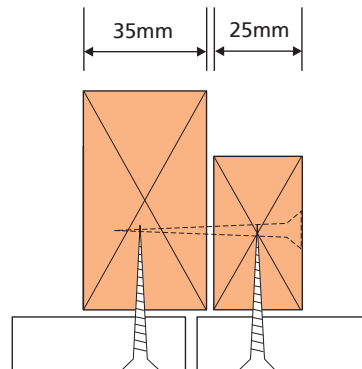

2 Increasing the bearing surface e.g. fixing boards to trussed rafters.

Avoiding fixing defects into timber

DO

- ✓ Use seasoned or kiln dried timber (preferably No.1 grade) to minimise the risk of drying shrinkage. *BS 8212* refers to 20% as being the maximum moisture content before drylining.
- ✓ Ensure timber supports are accurately spaced, aligned and levelled.
- ✓ Ensure that the dimensions and assembly of timber supports is sufficient to allow positive fixing of boards without bounce or undue deflection. If these fixing conditions can not be met, securely fix a timber batten to the side of the timber support to increase bearing surface.
- ✓ Fix boards tight to framing members.
- ✓ Use Gyproc Drywall Timber Screws to minimise any risks of nail popping. Alternatively, for timber joists fix Gypframe RB2 SureFix Bar to the underside to eliminate nail popping and to provide a positive fixing for boards using Gyproc Drywall Screws.

NB In all cases where defective or inadequate timber framing has been identified, defects must be rectified by suitable measures such as adjustment, inserting shims or replacement of affected timber prior to board fixing.

The use of timber which meets *BS 8212* moisture resistance, can still mean that nail popping can occur. The timber in use can 'dry down' to 8% causing shrinkage and twisting.

Good practice detailing

General

BS 8000 Part 8: 1994 Workmanship on Building Sites provides general guidance on good site practice. Specific reference is drawn to section 2.2 'Preparation of work, materials and components', covering liason, working conditions, distributed components and materials, cleanliness and protection, and suitability of backgrounds.

Acoustics

- Consider the layout and structure of buildings at the design stage to separate quiet and noisy areas
- Control sound paths around walls and floors to reduce flanking sound transmission
- Closely follow manufacturers' fixing details as deviations can negate any acoustic benefit
- Seal the base of the wall/drylining

NB When installing drylining, it is general practice to position the plasterboard so that a gap/break in contact occurs between the bottom edge of the plasterboard and the floor. It is important to seal this gap with a suitable filler prior to installation of the skirting. Furthermore, it is important to ensure that the base of the masonry wall is properly sealed prior to drylining to prevent an airspace being created straight under the wall.

- Tape and fill, or skim plaster plasterboard joints to increase airtightness
- Seal joints, junctions, penetrations, etc. to avoid air leakage
- Keep penetrations to a minimum
- Avoid back-to-back sockets

Deflection head details – acoustic performance

Deflection heads, by definition, must be able to move and, therefore, achieving an airtight seal is very difficult without incorporating sophisticated components and techniques. Air leakage at the partition heads will have a detrimental effect on acoustic performance of any partition. The approach shown in **Figure 3 - Deflection head A** could, for example, result in a loss of around 4dB to 5dB due to air leakage, in addition to that lost due to flanking transmission, etc.

Where acoustic performance is a key consideration, steps can be taken to minimise this loss of performance.

Figure 4 - Deflection head B shows the generally accepted method of achieving this and, provided care is taken to ensure a tight fit between cloaking angle and lining board surface, the loss in performance can be reduced. A loss in performance of around 1dB to 2dB would be typical with this method. Other factors, such as flanking transmission through the structural soffit, can significantly affect the overall level of sound insulation. Therefore, to optimise sound insulation performance, other measures may need to be taken.

Figures

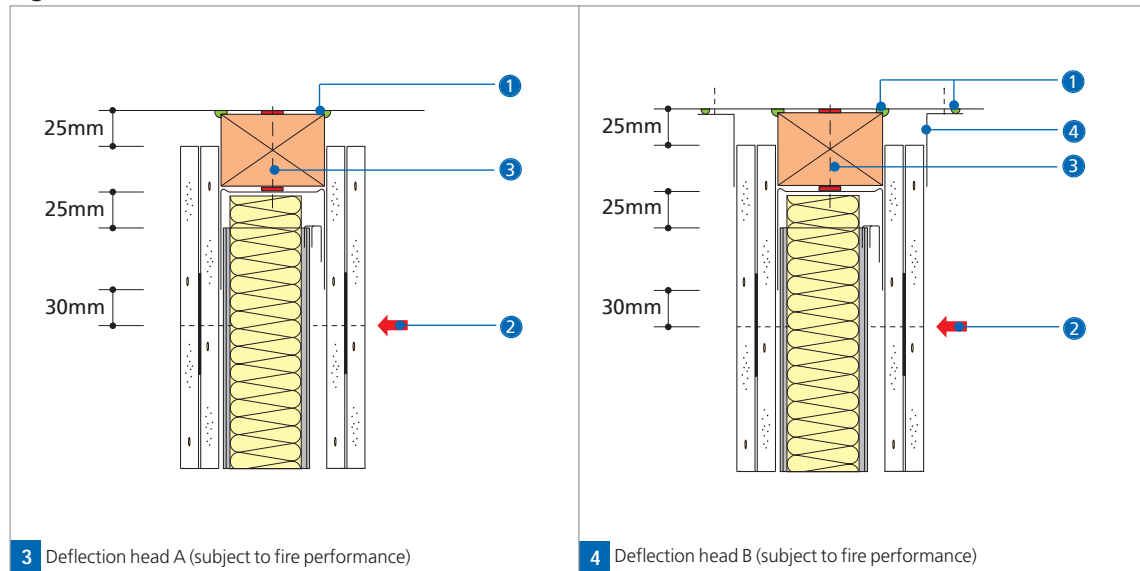

3 Deflection head A (subject to fire performance)

4 Deflection head B (subject to fire performance)

- 1 Gyproc Sealant for optimum sound insulation
- 2 Uppermost board fixings
- 3 50mm timber head plate equivalent to channel width forming fire-stop

- 4 Gypframe GA4 Steel Angle for optimum sound insulation

A suspended ceiling installed on both sides of the partition may provide a similar cloaking effect to that of steel angles. **CasoLine MF** can deliver a similar reduction in air leakage at the partition head. A tight fit between the ceiling perimeter and the surface of the partition lining board is important, although mechanically fixed perimeters are not essential. Ceilings with recessed light fittings may be less effective and if these cannot be sealed in some way, the installation of cloaking angles at the partition head should be considered. A suspended ceiling may also reduce the level of sound flanking transmission via the soffit.

Fire resistance

- Follow closely British Gypsum's installation instructions as deviations can negate any fire performance, e.g. plasterboard must be fully screw-fixed to framing supports
- Cut boards to a neat fit, avoiding any gaps

NB If small gaps do occur, they must be backed by a framing member and filled with appropriate jointing material or skim plastered.

- Tape and fill joints, or skim plaster plasterboard to achieve fire performance
- Fire-stop joints, junctions, penetrations, etc. to maintain integrity
- Keep penetrations to a minimum
- Avoid back-to-back sockets

Thermal performance

Seal lining perimeters and penetrations, etc. to avoid air leakage. Consider the use of Gyproc Soundcoat Plus on block external wall construction to reduce air leakage.

Robustness - partition duty ratings

All British Gypsum partition systems have a duty rating established in accordance with all the requirements of *BS 5234*. This rating relates to the strength and robustness characteristics of the partition system against specific end use applications. **Table 3** gives details of the four duty categories.

Table 3 - Duty ratings

Partition Duty	Category	Examples
Light	Adjacent space only accessible to persons with high incentive to exercise care. Small chance of accident occurring or misuse.	Domestic accommodation
Medium	Adjacent space moderately used, primarily by persons with some incentive to exercise care. Some chance of accident occurring or misuse.	Office accommodation
Heavy	Adjacent space frequently used by the public and others with little incentive to exercise care. Chance of accident occurring or misuse.	Public circulation areas, Industrial areas
Severe	Adjacent space intensively used by the public and others with little incentive to exercise care. Prone to vandalism and abnormally rough use.	Major circulation areas, heavy industrial areas

The series of tests are designed to determine the resistance to damage, both aesthetic and structural, from a range of impacts and load applications.

To claim a partition duty rating, all tests must achieve the designated performance level. It is not possible, for example, for a partition lined with a single layer of 12.5mm Gyproc WallBoard to achieve a duty rating better than Medium Duty, because of the board's performance in the hard body perforation test. In the majority of cases, the type of board used will determine the maximum partition duty rating. **Table 4** shows the maximum rating available based on a single layer board lining. In all cases, a double layer lining achieves Severe Duty.

Door detail

To achieve Heavy Duty or Severe Duty, the door detail needs to be reinforced, otherwise the door opening will undergo too much deflection and damage during the onerous door slamming test.

Table 4 - Board type required to achieve a given Duty Rating

Board type	Maximum rating
Gyproc WallBoard 12.5mm	Medium
Gyproc WallBoard 15mm	Medium
Gyproc SoundBloc 12.5mm	Medium
Gyproc SoundBloc 15mm	Medium
Gyproc FireLine 12.5mm	Medium
Gyproc FireLine 15mm	Heavy
Gyproc SoundBloc 15mm	Heavy [†]
Gyproc SoundBloc F 15mm	Heavy
Glasroc F MULTIBOARD 10mm	Heavy
Glasroc F MULTIBOARD 12.5mm	Severe
Gyproc DuraLine 15mm	Severe

[†] Minimum Gyframe 70mm Stud for Heavy Duty.

Maximum partition heights

As stated previously, *BS 5234: Part 2* does not contain a methodology for establishing the suitability of a partition in terms of height. The UK has

therefore adopted an internationally accepted methodology, which is based on the level of lateral deflection under a given uniformly distributed load (UDL). The criterion is that the maximum lateral deflection of the partition should not exceed $L/240$ (where L is the partition height) when the partition is uniformly loaded to 200Pa.

Fixings into drywall systems

There is a wide variety of fixing devices suitable for securing fixtures and fittings to British Gypsum systems. Generally, the choice of individual fixing devices will depend on the type of system and the loading requirements. This section gives recommendations on the selection of generic fixings. **Table 5** gives recommended fixing devices, and **Table 6** gives the recommended application in drywall systems to meet the specific load criteria. The guidance given is primarily concerned with fixtures at the time of installation. Subsequent installation is less easy, especially for heavier fixtures which will often require identification of the basic frame in hollow partitions or metal furring linings, or considerable care in the **DriLyner** systems, if the lining is not to be locally deflected.

It should be noted that, with drylined walls, there is normally a cavity to be bridged between the boards and the background. The fixing device should be long enough to allow for this and to penetrate well into the solid wall or background. When timber or metal framed partitions are used, lightweight fixtures can be made

directly to the partition linings. Medium weight fixtures should be made into the studs or to Gypframe 99 FC 50 Fixing Channels. Heavyweight fixtures (to BS 5234) such as wash basins, cupboards and shelving, should be fixed to Gypframe 150 FC 90 Fixing Channels. Gypframe 150 FC 90 Fixing Channels have been designed to suit Gypframe 'C' Studs, 'I' Studs, AcouStuds and GypLyner GL1 Lining Channels at 600, 400 or 300mm centres. The notched tabs both sides are first snipped at the desired positions (to suit stud module), bent to 90°, then fixed through pilot holes on each flange of the adjacent studs / channel. using Gyproc Wafer Head Screws. Where required, extra notches can be added by snipping and hammering flat. Once the partition is dry lined, the Gypframe 150 FC 90 Fixing Channels are securely 'trapped' between the plasterboard lining and the metal studs. To secure fixtures, suitable fixings are made into the Gypframe 150 FC 90 Fixing Channels. An example of a suitable fixing is a No.12 Self Tapping Screw with a 3mm pilot hole drilled through the fixing channel. See **Figure 8 - Gypframe 150 FC 90 Fixing Channel**. Gypframe Service Support Plates should be used to provide support to plywood noggings fitted within the partition cavity.

Table 5 - Recommended fixing devices and safe working loads

System	Lightweight fixtures up to 3kg (e.g. socket)	Lightweight to medium fixtures 4 - 8kg (e.g. small mirror)	Medium weight fixtures 9 - 20kg (e.g. shelf)	Medium to heavy fixtures 21 - 50kg (e.g. cupboard)	Heavy fixtures 51 - 100kg (e.g. basin)
ShaftWall GypWall systems ¹ GypLyner iWL	A	B or C	D or I	G, H or I	K or H
Timber stud	A	B or C	K or D	K	K
DriLyner	A	B	F	L	L
GypLyner UNIVERSAL wall lining	A	B or C	D or E	J, K or L	K or L

Table 5 - Recommended fixing devices and safe working loads (cont'd)







Reference	Detail	Description	Typical SWL ² (typical failure load)
A		No. 10 woodscrew into Gyproc plasterboard	3kg (12kg)
B		Steel picture hook and masonry nail into Gyproc plasterboard	4kg (16kg)
C		Metal self-drive into single layer Gyproc plasterboard	6kg (24k)
		Metal self-drive into double layer Gyproc plasterboard into timber nogging	8kg (32kg)
D		Steel expanding cavity fixing, e.g. M5 x 40, into Gyproc plasterboard (board thicknesses up to 12.5mm)	12kg (48kg)
		Steel expanding cavity fixing, e.g. M5 x 65, into plasterboard (board thicknesses from 15mm to 28mm)	18kg (72kg)
E		Gyproc Drywall Screw fixed through Gyproc plasterboard into 0.5mm Gypframe metal stud / Gypframe 99 FC 50 Fixing Channel	19kg (76kg)
F		Heavy duty plastic plug fixed through Gyproc plasterboard into masonry with 55mm minimum penetration	20kg (140kg)
G		Gyproc Jack-Point Screws fixed through Gyproc plasterboard into minimum 0.9mm Gypframe metal stud / Gypframe 150 FC 90 Fixing Channel	30kg (120kg)





Table 5 - Recommended fixing devices and safe working loads (cont'd)			
Reference	Detail	Description (typical failure load)	Typical SWL ²
H		No.12 self-tapping screws fixed through Gyproc plasterboard into minimum 0.9mm Gypframe metal stud / Gypframe 150 FC 90 Fixing Channel	50kg (200kg)
I		Steel expanding metal cavity fixing, e.g. M4 x 40, through Gyproc plasterboard into 0.9mm Gypframe metal stud / Gypframe 150 FC 90 Fixing Channel (board thicknesses up to 12.5mm)	40kg (160kg)
		Steel expanding metal cavity fixing, e.g. M4 x 65, through Gyproc plasterboard into 0.9mm Gypframe metal stud / Gypframe 150 FC 90 Fixing Channel (board thicknesses from 15mm to 28mm)	50kg (200kg)
		Steel expanding metal cavity fixing, e.g. M5 x 65, fixing through Gyproc plasterboard into plywood supported by Gypframe Service Support Plate	50kg (200kg)
J		8mm steel frame fixing fixed through Gyproc plasterboard into masonry with minimum 55mm penetration	60kg (240kg)
K		No.12 self-tapping screw fixed through Gyproc plasterboard into timber sub-frame	120kg (480kg)
L		M8 steel bolt / anchor fixed through Gyproc plasterboard into masonry with minimum 55mm penetration	130kg (520kg)

Table 5 - Recommended fixing devices and safe working loads (cont'd)

1 For GypWall QUIET SF, ensure that the fixings do not bridge the Gypframe RB1 Resilient Bars, otherwise the acoustic performance may be compromised.

2 Safe Working Load (SWL) - a safety factor of 4 (steel fixings) and 7 (plastic fixings) has been used.

For technical assistance on above fixings please contact the fixings manufacturer. The suitability of the fixing must be confirmed by the building designer / fixing manufacturer.

Reference can also be made to the Construction Fixing Association (CFA) guidance note 'Fixing For Plasterboard', which is currently under review by the CFA and can be accessed at www.fixingscfa.co.uk

When specifying a fixing to / through Gyproc ThermoLine laminates, please give consideration to the thickness and compressibility of the insulation to ensure that the fixing used is fit for purpose.

The information within Table 5 does not take into consideration any additional forces that may be applied whether it be accidental, abuse or otherwise.

The example fixing devices, typical safe working loads and typical failure loads given in Table 5 relate to the installation of single fixtures. It is important to ensure that the drylining system specified is capable of supporting the loads, particularly if installing multiple fixtures.

Services installations

Services with partitions and lining cavities

The installation of electrical services should always be carried out in accordance with the requirements of the Institution of Electrical Engineers Wiring Regulations (*BS 7671*) which is the technical standard required of Approved Contractors enrolled with the National Inspection Council for Electrical Installation Contracting.

Services can be incorporated in all British Gypsum lining systems, partitions and ceilings.

Gypframe studs or wall lining channels either have cut-outs or push-outs to accommodate routing of electrical services. Grommets or isolating strip should be installed in the cut-out to prevent abrasion of the cables. Switch boxes and socket outlets can be supported on brackets formed from Gypframe 99 FC 50 Fixing Channel or cut and bent channels fixed horizontally between the studs. Alternatively, a high performance socket box detail can be used where higher acoustic performance is required.

Gypframe channels do not generally have cut-outs, these need to be cut on site, paying attention to Health and Safety issues. Grommets or isolating strip should be installed in these cut-outs to prevent abrasion of the cables.

If a lining system, such as **DriLyner**, does not have sufficient depth to accommodate the service then the background should be 'chased out' to the appropriate depth. Pipes or conduits should be fixed in position before work commences.

To maintain an airtight construction, the perimeter of any penetration through the lining should be sealed as necessary at the time the services are being installed.

The insulating backing of Gyproc ThermaLine laminates should not be chased to accommodate services. PVC covered cables must not come into contact with polystyrene insulation. Suitable isolation methods such as conduit or capping should be used (NHBC Standards 8.1).

In the case of gas service pipes behind drylined walls, *BS 6891* states that the pipe should be encased in building material. This could take the form of Thistle plaster, Gyproc Dri-Wall Adhesive totally encasing the pipe, or timber battens fixed either side of the pipe where the framing for the plasterboard is timber.

The following notes refer to specific service installation requirements in **GypWall** systems.

Walls 100mm thick or less

A zone formed by the installation of electrical accessories on one side of the wall or partition extends to the reverse side. This means that the concealed cable may be less than 50mm from the surface of the wall or partition on the reverse side.

Therefore, before carrying out work, e.g. drilling into the surface, the other side of the wall or partition must always be checked in order to determine the location of any concealed cables. It is good practice to maintain a clear zone.

Where the location of electrical outlets cannot be determined from the reverse side, then the cable must either be mechanically protected or run at least 50mm from the surface of the wall or partition on the reverse side (see **Figure 5 - Minimum distance of cabling**, and **Figure 6 - Standard zones of cabling**).

GypWall RAPID dB Plus

Electric cables, conduits and pipes up to 25mm outside diameter can easily be accommodated within the cavity of the system.

Gypframe GWR3 Floor & Ceiling Channels have circular cut-outs at regular centres. Gypframe Nogging Channels have half round cut-outs. These cut-outs are designed to prevent abrasion of electrical cables where they pass through the metal framework, therefore grommets are not required.

Other sections, such as Gypframe 43 AS 50 AcouStud, will need grommets or isolating strip to prevent abrasion. The cut-out in the cross nogging component, Gypframe Nogging Channels, allow PVC insulated and sheathed cable up to 4mm² to be installed without earthed metallic covering.

Heating Pipes

Where heating pipes, particularly micro-bore systems, are to be located within the **GypWall** system, it is recommended that only one pipe is passed through each aperture in the metal framework. If this cannot be accommodated for whatever reason, it may be necessary to incorporate proprietary pipe restraining clips, or other means of keeping the pipes apart, to prevent vibration noise.

Service ducts

Where a large number of electrical cables or pipes have to be accommodated when the framing is at 900mm centres, a service duct can be created by closing-up the stud centres to 450mm and omitting the intermediate nogging.

GypWall systems : ShaftWall : FireWall

The cut-outs in the studs can be used for routing electrical and other small services. Where Gypframe AcouStuds are used, services are routed through 'H' shaped push-outs, 50 x 28mm at the centres, as shown in **Figure 9 - Gypframe studs service cut-out details – 'C' and 'I' studs** and **Figure 10 - Gypframe studs service push-out details – AcouStuds**.

Service penetrations

Fixing electrical socket boxes into British Gypsum partitions and walls can impair both fire and acoustic performance, but with careful detailing this can be minimised. The national Building Regulations Part E offers specific guidance for the installation of socket boxes in separating walls, particularly the avoidance of back-to-back services. The plasterboard should always be neatly cut and Gyproc Sealant should be applied where optimum acoustic performance is required.

In fire-rated walls, the fire-stopping design is dependant on the period of fire resistance. Some typical details are shown in **Figure 11 - Socket box installation – up to 60 minutes fire resistance** and **Figure 12 - Socket box installation – up to 120 minutes fire resistance**.

For high acoustic performance socket box details, please refer to **GypWall QUIET** system.

In wall linings and ceilings, access for services may be required for routine maintenance, inspection, upgrading or repair. This can be achieved by installing Gyproc Proflex Access Panels.

Dampers

Fire and smoke resisting dampers can be installed in British Gypsum's **GypWall** range of partitions and walls. Dampers prevent fire and smoke from passing from one fire compartment to another through heating, ventilation and air conditioning systems. 'An Industry Guide to the Design for the Installation of Fire and Smoke Resisting Dampers' is available

from the ASFP or as a download from their website www.asfp.org.uk. This document refers the designer to the principles of construction, and in particular to tested constructions, or to constructions assessed for performance in fire by a suitably qualified person.

Figure 13 - Opening bridging studs for duct / damper penetration, Figures 15, 16, 17 - Openings for service penetrations in fire-rated partitions and Figure 14 - Fire tested construction in which the damper is supported by the partition show a method of preparing openings for installing dampers up to a maximum weight of 57kg within British Gypsum systems. As the performance of the complete assembly will depend on a number of elements, the actual details of the opening need to be determined in conjunction with the fire-stopping and damper manufacturers.

Penetrations of fire resistant constructions for services need careful consideration to ensure that the integrity of the element is not impaired, and also that the services themselves do not act as the

mechanism of fire spread. It is important to use only those services and their installations which have been shown by fire test to be able to maintain the integrity of the construction. By designing service zones through which all services pass, the number of individual service penetrations can be minimised. Service zones can be sealed after installation of the services using a tested and substantiated fire-stopping system.

In most situations, the services will be installed by contractors other than the drylining contractor. It is important, therefore, that all relevant contractors should be advised as to where and how their service penetrations should be made and maintained. The necessity to independently support services will depend on their size and weight. Please refer to **Table 5 - Recommended fixing devices and safe working loads**.

Services can be fixed to the face of a **GypWall** partition, using a Gypframe Service Support Plate, which carries 12.5mm plywood within the cavity of

the partition as shown in **Figure 7 - General arrangement of service support plates showing studs at 600mm centres**. An alternative to this would be to install a metal or timber support framework within the cavity of the partition. Consult the British Gypsum Drywall Academy Technical Advice Centre for further detailed information.

Access to services

Gyproc Profilex Access Panels have been designed and tested in order to offer practical, cost effective solutions. For more information, please refer to the British Gypsum website www.british-gypsum.com

Figures

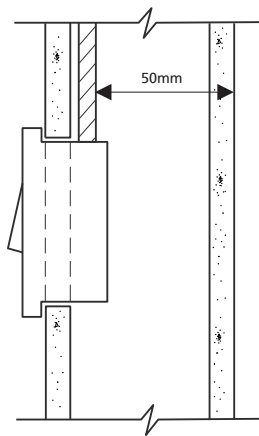

5 Minimum distance of cabling

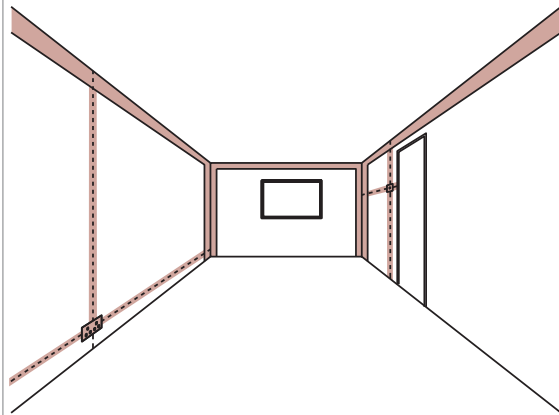

6 Standard zones of cabling

Figures

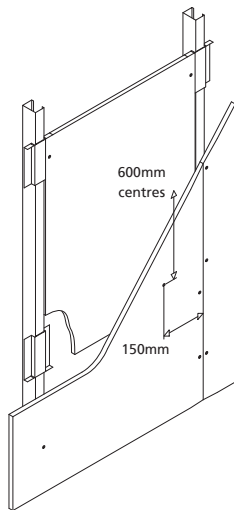

7 General arrangement of Gyframe Service Support Plates showing studs at 600mm centres

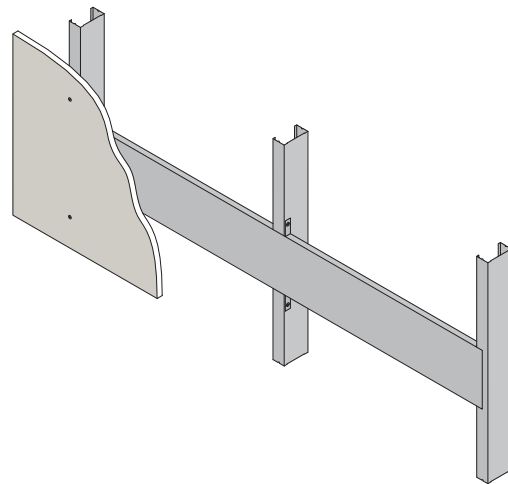

8 Gyframe 150 FC 90 Fixing Channel

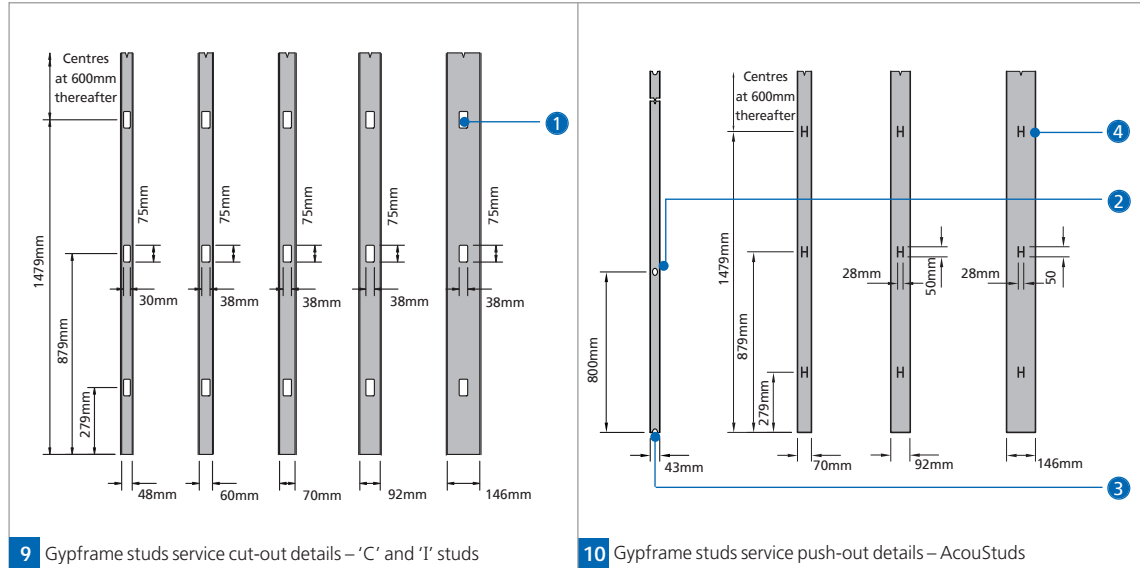

9 Gypframe studs service cut-out details – 'C' and 'I' studs

10 Gypframe studs service push-out details – AcouStuds

- 1 Rectangular cut-out
- 2 25mm wide x 35mm high oval cut-out
- 3 Half cut-out at top and bottom
- 4 'H' profile 'push-outs'

Figures

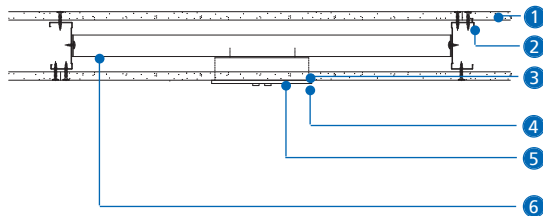

11 Socket box installation - up to 60 minutes fire resistance

- 1** Gyproc plasterboard
- 2** Gyproframe 70 S 50 'C' Studs at 600mm centres
- 3** Plasterboard cut to allow a close fitting entry for the socket box
- 4** Gyproc Sealant at switch box perimeter for improved acoustics
- 5** Electrical socket with metal back box

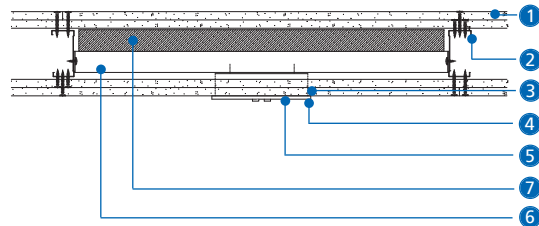

12 Socket box installation - up to 120 minutes fire resistance

- 6** Gyproframe 72 C 50 Standard Floor & Ceiling Channel receiving fixing of socket box - channel legs tabbed, bent and fixed to metal studs with Gyproc Wafer Head Drywall Screws
 - 7** Stone mineral wool (min. 80kg/m³) backing to the socket box
- NB** For high acoustic performance socket box details, please refer to GypWall QUIET systems

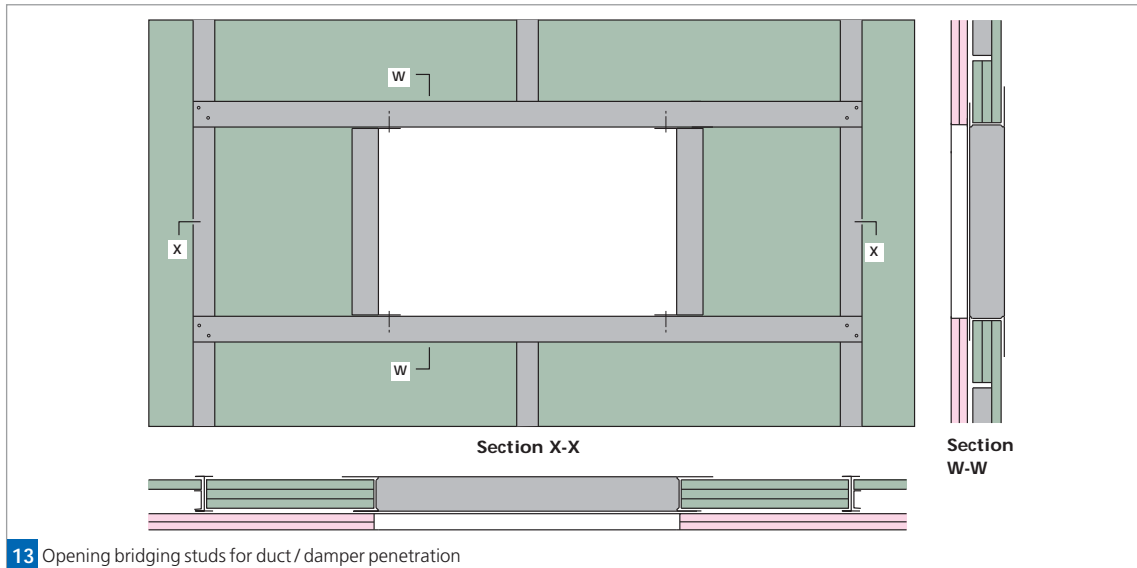

13 Opening bridging studs for duct / damper penetration

Figures

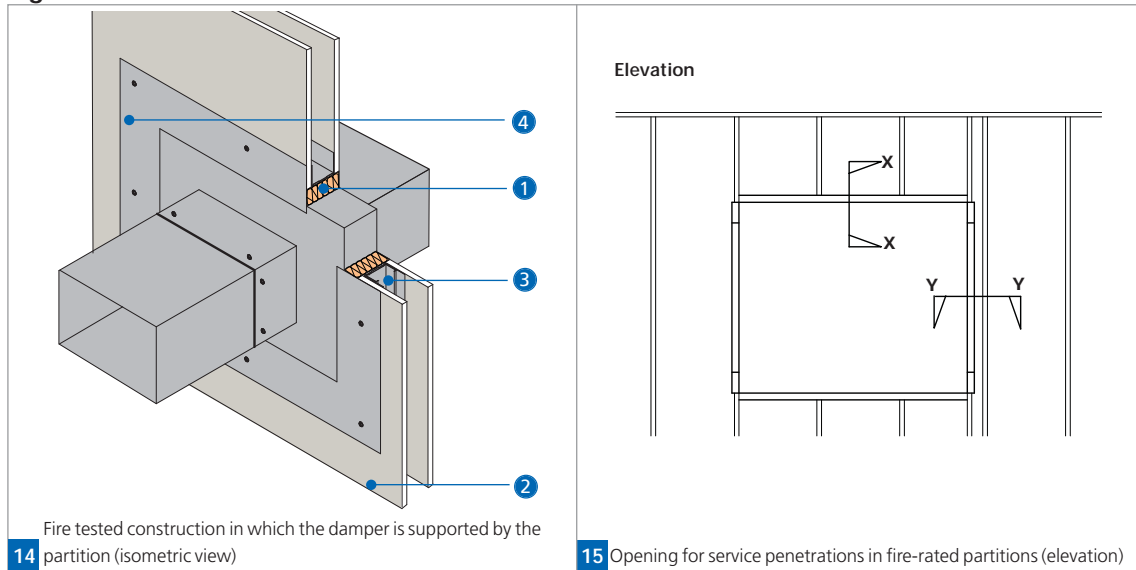

14 Fire tested construction in which the damper is supported by the partition (isometric view)

- 1** Stone mineral wool (80kg/m^3)
- 2** Gyproc or Glasroc plasterboard
- 3** Gypframe stud

Elevation

15 Opening for service penetrations in fire-rated partitions (elevation)

- 4** Damper (by others). Weight of damper should not exceed 57kg. Size of damper should not exceed 1400 x 1200mm.

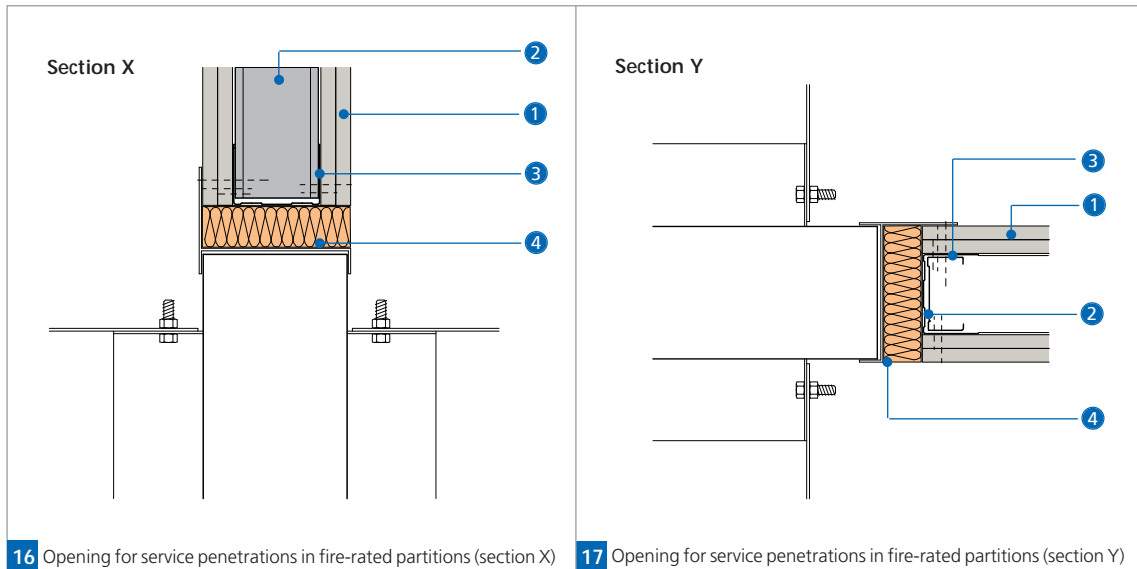

- 1** Gyproc plasterboard or Glasroc specialist board
- 2** Gypframe 'C' Stud
- 3** Gypframe Floor & Ceiling Channel

- 4** Penetration seal (as tested by damper manufacturer or proprietary alternative, confirmed as compatible by system designer / specifier)

2

Manual lifting and handling	39
Safe systems of work	40
Loading and unloading pallets	40
Mixing	41
Picking from mid level	43
Handling buckets	43
Handling lengths of metal	44
Handling boards	47
Carrying board up / down stairs	49
Fixing walls	49
Lifting plasterboards into place (including ceilings)	50
Fixing ceilings	51

Manual lifting and handling

British Gypsum recognises the increasing importance of Health and Safety. As such, we have been working with Pristine Condition, experts in this field, to develop a series of safe systems of work for manual lifting and handling of our products.

The simple guidance in this section suggests appropriate methods for handling British Gypsum products including Gyproc plasterboards, Thistle plasters, Gypframe metal sections, Glasroc boards and Arteco ceiling products.

All content and imagery in this section has been produced in association with



Safe systems of work

- Wherever possible, place one foot in front of the other to produce a good base and reduce the pressure on the body
- Assess the load by placing your hand on it and moving it
- Only handle what you feel you can manage
- Initiate movements with your legs, unlocking the knees and drive with the legs to start the lift
- Keep the load as close, or get as close as possible to the load when lifting or handling
- Turn instead of twisting and move your feet
- Let your back find its natural curvature
- Never lose control of the load



Loading and unloading pallets

- PPE: Safety shoes required
- Always place one foot forward by operating from the corner of the pallet or placing one foot on the pallet taking care to ensure that the pallet does not tip in the process
- Unlock the knees for low level work
- Take a firm grip of the load with both hands
- Lift using the legs to start the movement
- Turn by moving the feet



2

- Always keep the load close when carrying



3

- DO NOT LIFT WITH FEET IN LINE OR WITH LOAD IN FRONT OF THE FRONT FOOT



1

Mixing

Emptying bags into a mixer

- PPE: Mask, eye protection, hard hat and safety shoes required
- Always place one foot down by the side of the mixing container
- Unlock the knees if necessary
- Turn by moving the feet



- DO NOT EMPTY BAGS WITH FEET IN LINE



When mixing

- PPE: Mask, eye protection, hard hat and safety shoes required
- Keep the foot to the side of the mixing container
- Unlock the knees if necessary
- Maintain a balanced position



- DO NOT WORK WITH FEET IN LINE



Picking from mid level

- PPE: Hard hat and safety shoes required
- Place one foot forward
- Take a firm grip of the load
- Pull the load to a point of pivot (using the legs if necessary)
- Pivot against the stack
- Keep the load close
- Turn by moving the feet



- DO NOT TWIST
- DO NOT PICK WITH FEET IN LINE



Handling buckets

- PPE: Hard hat and safety shoes required
- Always place one foot alongside the bucket before lifting, or pivot the bucket towards you before lifting
- Take a firm grip with both hands
- If heavy, you may need to tilt and take a grip of the base and the top of the bucket
- Start the lift with the legs
- Unlock the knees for low level work

- Always turn by moving the feet
- If taking two buckets, always carry in a balanced manner
- Only handle what you can manage
- DO NOT CARRY HEAVY OBJECTS ON ONE SIDE
- DO NOT TWIST



1

Handling lengths of metal

One person

- PPE: Gloves, hard hat and safety shoes required
- Always approach the lengths of metal from one end
- Place one foot forward
- Unlock the knees for low level work
- Take a firm grip
- Lift with the legs



2

- DO NOT PICK FROM THE MIDDLE OF THE STACK



Option 1

- Work your way to the middle
- Pivot the stack and carry in a balanced manner



Option 2

- Place over the shoulder
- Work your way to the middle (point of balance)



- Unlock the knees to rest the stack against the shoulder
- Allow the stack to pivot against the shoulder as you stand up



6

- Only carry over the shoulder if you can remain upright
- Be aware of your surroundings when carrying lengths of metal in this way



7

- DO NOT LEAN



8

If removing from racks:

- PPE: Gloves, hard hat and safety shoes required
- Place one foot forward
- Drive with the legs to bring the load to one end
- Carry in a balanced manner



- Always communicate during the lifts and carrying



Handling boards

One person

- PPE: Hard hat and safety shoes required
- Pull the board in towards yourself
- Unlock the knees for low level work
- Lift by using the legs



- Carry the board in a balanced manner (for large boards, you can support the board on the top of the chest / shoulder)
- Only lift what you feel you can manage
- If necessary, seek assistance

**Two person****Picking**

- Operate from the corners of the stack
- Unlock the knees for low level work
- Lift board together to vertical position
- Only lift what you feel you can manage

**Carrying**

- Carry in a balanced manner across the body
- If walking backwards, ensure it is over the shortest possible distance and clear the route beforehand



- DO NOT CARRY HEAVY OBJECTS ON ONE SIDE



Carrying board up / down stairs

- PPE: Hard hat and safety shoes required
- Whether going up or down stairs, place one foot forward then bring both feet together on each step
- Keep the boards in a balanced manner
- Place both feet on each step before moving off to improve control and balance throughout the lift

- Work together in timing
- Stop wherever necessary (if steps are in poor order, or have a deeper drop, you may need to place the load down first)
- Only lift what you feel you can manage



Fixing walls

- PPE: Eye protection, hard hat and safety shoes required
- Operate in a balanced manner
- Always keep one foot forward
- Unlock the knees for low level work



- Always work in front of the body
- Use appropriate platforms where necessary
- DO NOT OVER-REACH OR STRETCH TO THE SIDES OR ABOVE THE HEAD



Lifting plasterboards into place (including ceilings)

Two person operation

- PPE: Eye protection, hard hat and safety shoes required
- Communicate – work together
- Take a firm grip of the board in both hands



- Unlock the knees to place board into position
- Always work in front of the body



Fixing ceilings

- PPE: Eye protection, hard hat and safety shoes required
- Always work in a balanced position
- Operate with one foot forward
- Keep the body upright
- Always use appropriate platforms where necessary



- DO NOT OVER REACH

Technical support and product training

Technical support

The British Gypsum Drywall Academy provides a single point of contact for queries on the application and use of the Company's products and systems. An experienced technical team is on hand to deal with enquiries from architects, builders' merchants and distributors, builders, contractors - in fact anyone involved in the specification and installation of British Gypsum systems.



Support includes:

- Technical advice and assistance via phone, fax and e-mail
- Solutions to project detailing problems
- Thermal dewpoint calculations
- U-value calculations
- NBS specification clauses

Contact Details

Tel: 0844 800 1991;

#1 (Literature), #2 (Technical)

For quality and security reasons, calls may be recorded

Fax: 0844 561 8816

Email: bgtechnical.enquiries@bpb.com

British Gypsum
Drywall Academy
East Leake
Loughborough
Leicestershire
LE12 6HX

The British Gypsum website also contains a significant amount of technical information including a frequently asked questions section that contains answers to many of the most popular enquiries received by the Drywall Academy.

www.british-gypsum.com

Product training

British Gypsum's Drywall Academy has been at the centre of training and development of plaster and drylining systems for over 40 years. The company's three purpose-built training centres at Erith in Kent, East Leake near Nottingham and Kirkby Thore in Cumbria, alongside satellite centres in Glasgow and Liverpool, offer training of unequalled professionalism and quality. Specialised training in drylining, suspended ceilings, fire protection, and decorative finishing is aimed at improving the knowledge and skills of:

- tradesmen and contractors
- specifiers
- site supervisory staff
- merchanting and distribution personnel
- technical support staff
- sales personnel



By investing in training at the Drywall Academy, firms enhance their reputation and profitability as well as improving employee skills and motivation. British Gypsum's goal is to deliver a total training package, so, for example, delegates on a supervisory course not only receive all the necessary training, but will have all the reference and support materials at hand to undertake the tasks back in the work environment.

Courses are run throughout the year at all training centres. In addition, where there are six or more delegates, British Gypsum can arrange bespoke training for many of the company's systems at the workplace itself. A ConstructionSkills (CITB) grant is available for many of the training programmes.

**To discuss your requirements,
check on course availability
or to book a place telephone
0844 561 8810**

Drywall Academy training courses - call 0844 561 8810 for details

Systems training - wall linings

British Gypsum DriLyner 'dot and dab' systems

This two day course covers the standard methods for drylining brick and blockwork backgrounds. Combine this course with the Hand Jointing course for the ideal introduction to drylining.

Suitability: There are no formal entry requirements and this is an excellent course for newcomers who wish to develop a career in drylining.

British Gypsum GyLyner wall lining system

A one day course covering details of this very popular wall lining system. Particularly suited to refurbishment work where walls may be badly out of plumb or where extensive services need to be accommodated.

This course is run in conjunction with the British Gypsum **CasoLine MF** course.

Suitability: No formal entry requirements, but trainees should have a basic understanding of site practices.

Systems training - partitioning

British Gypsum GypWall metal stud partition system

This two day course gives an introduction to the widely specified **GypWall** metal stud internal partitioning system.

This course is run in conjunction with the British Gypsum **CasoLine MF** course.

Suitability: No formal entry requirements, but trainees should have a basic understanding of site practices.

Systems training - ceilings

British Gypsum CasoLine MF ceiling system

A one day course to cover one of the easiest ways to form a flush, seamless suspended ceiling. The

CasoLine MF system consists of lightweight metal sections suspended on steel hangers on to which Gyproc plasterboard is screwed.

This course is run in conjunction with the British Gypsum **GypWall** metal stud partition course.

Suitability: No formal entry requirements, but trainees should have a basic understanding of site practices.

Finishing

Hand jointing and finishing plasterboards

This two day course covers all aspects of finishing plasterboards to provide a smooth, seamless, crack resistant finish using Gyproc jointing systems.

Suitability: No formal entry requirements, but this course is a must for anyone involved with internal finishing. It is also suitable as a follow up course to the **DriLyner** wall lining system and **GypWall** metal stud courses.

Mechanical jointing

This three day course covers the use and basic maintenance requirements of Gyproc Speed Tape tools. Suitable for larger contracts, Speed Tape tools produce a high quality finish at twice the speed of hand jointing.

Suitability: Trainees should have undertaken the hand jointing course or have had site experience of drywall finishing.

Skim finishing and basic trowel skills

This three day course is designed as an introduction to skimming of plasterboard using Thistle Board Finish and Thistle Multi-Finish. It is one of the most popular ways of finishing plasterboard prior to decoration, as it gives a smooth, high quality appearance similar to that of two-coat wet plastering.

Suitability: The course is designed for 'improvers' who have basic jointing and finishing skills.

Artex decorative finishes - brush work

This two day course introduces the trainee to a new dimension in decorative finishes utilising a range of the most popular random designs.

Suitability: This is an essential course for all beginners and must be completed before the advanced comb work course can be undertaken.

Artex decorative finishes - comb work

This is an advanced two day course that introduces the trainee to the artistic designs achievable with Artex texture.

Suitability: This course is for texturers experienced in brush work and wishing to develop their skills.

Artex decorative finishes - cornice and coving

A one day course to provide the skills required to fix cast and paper encased plaster cove and cornice products.

Suitability: The course is suitable for site operatives wishing to develop additional skills in decorative finishes.

Artex Smooth-It course

A one day course to provide the skills required to 'smooth' a previously textured ceiling.

Suitability: The course is suitable for site operatives wishing to develop their skills.

Other training

- 'A guide to insulation', covering acoustics and thermal insulation
- 'Understanding fire protection', the products, their installation, their benefits
- Management of drylining
- Targeted merchant courses
- MOD drylining course
- 'Young entrants' drylining course

SpecSure® lifetime system warranty

All of British Gypsum proprietary systems included in this **SITE BOOK** are covered by the **SpecSure®** Lifetime Performance Warranty.

Unique to British Gypsum, the **SpecSure®** lifetime warranty is designed to give you total confidence that the systems you have chosen will meet the most rigorous of building requirements.

All of our systems are developed using the highest quality components, designed to work together, and are specially developed to give you a lifetime of confidence.

SpecSure® is more than just a performance warranty. It means that the British Gypsum systems you specify:

- Have a guaranteed lifetime performance.
- Have the technical expertise and experience of the UK's leading drywall specialists behind it.
- Have been tested in UKAS-accredited fire, acoustic, and structural test laboratories.
- Have been site tested to demonstrate installation integrity and simplicity.
- Will be supported at every stage of the project by the UK's leading on and offsite technical support personnel.
- Will perform to published parameters throughout the life of each system.
- Will be repaired or replaced by British Gypsum in the unlikely event of system failure attributed to unsatisfactory product / system performance.

SpecSure® - system performance warranted for life

Qualifying for SpecSure®

- Specify and install British Gypsum systems in line with the recommendations in the current British Gypsum **WHITE BOOK**
www.british-gypsum.com
- The systems must comprise only genuine branded British Gypsum components (**Gyproc, Thistle, Gyproframe, Glasroc and Arteco**), tried and tested in buildings for many decades. We cannot guarantee that the use of other manufacturers' components will meet our rigorous performance and quality standards when installed in our tested systems.



GypWall CLASSIC and GypWall ROBUST

The definitive metal stud and partition system

GypWall CLASSIC partitions are cost-effective, multi-purpose partitions, which have provided the industry standard for many years. They are suitable for all types of buildings, including residential, healthcare and commercial.

GypWall ROBUST is a high impact-resistant partition system for use where a more durable structure is required. It provides a lightweight, cost-effective, non-loadbearing partition suitable for all types of commercial, healthcare, institutional and industrial buildings.



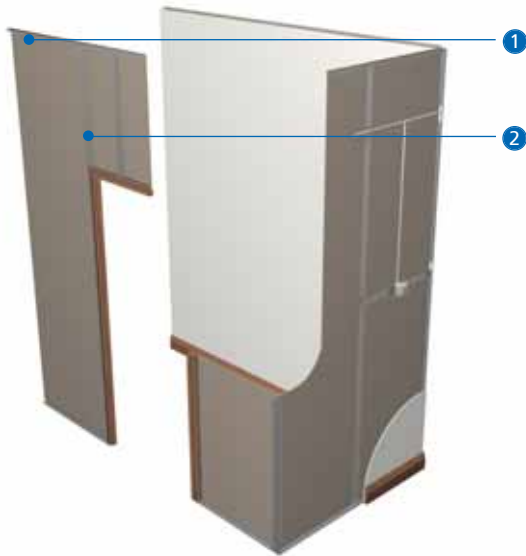

- 1 Gypframe Standard, Deep Flange (DC) or Extra Deep Flange (EDC) Floor & Ceiling Channel
- 2 Gypframe studs

Key facts

- Range of stud options to match performance requirements
- Acoustic stud option for enhanced acoustic performance
- Satisfies *BS 5234* strength and robustness requirements up to Severe Duty
- Achieves high levels of sound insulation up to R_w 61dB
- Easily accommodates services within stud cavity
- Can allow for deflection at the head
- Gypframe metal framework will not twist, warp or rot

Components

Gyproc board products

			Take-off quantities ¹
	Gyproc WallBoard²		200m ² per layer
Thickness	12.5, 15mm		
Width	1200mm		
	Gyproc FireLine²		200m ² per layer
Thickness	12.5, 15mm		
Width	1200mm		
	Gyproc SoundBloc²		200m ² per layer
Thickness	12.5, 15mm		
Width	1200mm		
	Gyproc SoundBloc F		200m ² per layer
Thickness	15mm		
Width	1200mm		

Specialist board products

			Take-off quantities ¹
	Gyproc Plank		200m ² per layer
Thickness	19mm		
Width	600mm		
	Gyproc DuraLine³		200m ² per layer
Thickness	15mm		
Width	1200mm		
Length	2400, 3000mm		
	Glasroc F MULTIBOARD		200m ² per layer
Thickness	10, 12.5mm		
Width	1200mm		
	Glasroc H TILEBACKER⁴		100m ² per outer layer
Thickness	12.5mm		
Width	1200mm		







¹ Quantities are for 100m² of straight partition boarded with a double layer of board each side. Quantities are approximate and for guidance only, no allowance has been made for waste, openings, abutments, etc. Refer to **section 11 - Quantity take-off details**.

² Moisture resistant boards are specified in intermittent wet use areas.





³ Where single layer Gyproc DuraLine (GypWall ROBUST) is being fixed to Gypframe 'C' Studs, these should be a minimum gauge of 0.6mm.





⁴ Glasroc H TILEBACKER is suitable for use in high moisture environments. Where the board is being used on a double layer system, it should only be used as the outer layer. For tiling guidance, refer to **section 10 - Tiling**.

Gypframe metal products	Take-off quantities	Gypframe metal products	Take-off quantities
 <p>Gypframe 'C' Studs Width 48, 60, 70, 92 and 146mm Length 2400 - 4200mm Codes 48 S 50, 60 S 50, 70 S 50, 70 S 60, 92 S 50, 92 S 60 and 146 S 50.</p>	167m	 <p>Gypframe Standard Floor & Ceiling Channels 50 C 50, 62 C 50, 72 C 50, 94 C 50, 148 C 50 Gypframe Deep Flange Floor & Ceiling Channels 50 DC 60, 62 DC 60, 72 DC 60, 94 DC 60, 148 DC 60 Gypframe Extra Deep Flange Floor & Ceiling Channels 50 EDC 70, 72 EDC 80, 94 EDC 70, 148 EDC 80 All channels are available in 3600mm only</p>	Dependant on partition length
 <p>Gypframe AcouStud Width 70, 92 and 146mm Length 2400 - 4200mm Codes 70 AS 50, 92 AS 50 and 146 AS 50</p>	167m	 <p>Gypframe GFS1 Fixing Strap Length 2400mm</p>	As required
 <p>Gypframe 70I50 'I' Stud Width 70mm Length 3600, 4200, 4500mm</p>	167m	 <p>Gypframe 99 FC 50 Fixing Channel Length 2400mm</p>	As required

Gypframe metal products		Take-off quantities	Fixing and finishing products		Take-off quantities ¹
	Gypframe 150 FC 50 Fixing Channel Length 1194mm	As required		Gyproc Drywall Screws For fixing boards to stud framing up to 0.79mm thick.	1 st layer - 1750 2 nd layer - 2250
	Gypframe GA5 Internal Fixing Angle Lengths 2400 & 3600mm	As required		Gyproc Jack-Point Screws For fixing boards to stud framing 0.8mm thick or greater and 'I' studs greater than 0.5mm thick.	1 st layer - 1750 2 nd layer - 2250
	Gypframe GA6 Splayed Angle Lengths 2400 & 3600mm	As required		Gyproc Wafer Head Drywall Screws For metal-to-metal fixing up to 0.79mm thick.	as required
				Gyproc Wafer Head Jack-Point Screws For metal-to-metal fixing 0.8mm thick or greater and 'I' studs greater than 0.55mm thick.	as required

¹ Quantities are for 100m² of straight partition boarded with a double layer of board each side. Quantities are approximate and for guidance only, no allowance has been made for waste, openings, abutments, etc. Refer to section 11 - Quantity take-off details.

Fixing and finishing products		Take-off quantities ¹
 Gyproc Sealant For sealing airpaths for optimum sound insulation.		1 cartridge per 35m based on a 6-10mm bead
 Gyproc edge beads Protecting and enhancing board edges.		as required
 Gyproc Control Joint To accommodate structural movement.		as required
 Gyproc FireStrip For sealing deflection heads.		as required
 Gyproc jointing materials For a seamless finish.		as required

Fixing and finishing products		Take-off quantities ¹
 Thistle Multi-Finish or Thistle Board Finish To provide a plaster skim finish.		10m ² per 25kg bag
or		
 Thistle Durafinish To provide improved resistance to accidental damage.		10m ² per 25kg bag
or		
 Thistle Spray Finish Gypsum finish plaster for spray or hand application.		11m ² per 25kg bag
 Isover APR 1200 For enhanced acoustic performance.		100m ² where specified
 Isover Modular Roll 80mm, for improved acoustic performance.		100m ² where specified
 Isover Acoustic Slab - High performance 75mm, for improved acoustic performance.		100m ² where specified

Construction tips

- Estimated construction time 2m² - 3m² / man hour (single layer partition) or 1.5m² - 2m² / man hour (double layer partition) ready for finishing
- Use full height boards wherever possible - if horizontal joints are unavoidable, endeavour to position them above the suspended ceiling or below access floor level. Avoid eyeline and strong wall lighting areas
- Fixtures / fittings - additional framing will be required to support heavyweight items (e.g. sanitary ware)
- Support horizontal joints with Gypframe GFT1 Fixing 'T', Gypframe GFS1 Fixing Strap or Gypframe 99 FC 50 Fixing Channel (where specified)
- Where single layer Gyproc DuraLine (**GypWall ROBUST**) is being fixed to Gypframe 'C' Studs these should be a minimum gauge of 0.6mm - unless using Gypframe AcouStuds
- Install Gyproc Control Joints where specified
- Incorporate deflection heads where specified
- Consider skirting fixing - mechanical or using Gyproc Sealant
- If doorsets are fixed at a later stage allow a 10mm overall tolerance in width, 5mm in height
- Consider additional door detailing to BS 5234

Installation



- Determine and mark the wall position and make allowance for openings.
- Fix Gypframe Floor & Ceiling Channel along the centre line to the floor and ceiling at 600mm centres with suitable fixings.
- For **GypWall ROBUST** use Gypframe DC or EDC Floor & Ceiling Channels.
- On uneven floors, a timber sole plate, 38mm deep x width of stud, may be required.

- On new concrete or screeding, consider installing a damp proof membrane to the full partition width before locating the floor channel or sole plate.



- 94mm and 148mm channels require two rows of staggered fixings (600mm centres in each row).
- For partition heights between 4200mm and 8000mm Gypframe Deep Flange Floor & Ceiling Channel (DC) should be used at head and base (subject to deflection head).
- For partitions above 8000mm Gypframe Extra Deep Flange Floor & Ceiling Channel (EDC) should be used at head and base (subject to deflection head).



- Cut studs to a neat fit (maximum possible entry into head and base channel).

NB Cut studs to size using a chop saw, hacksaw or snips.

NB For deflection heads, the method will vary to suit requirement.

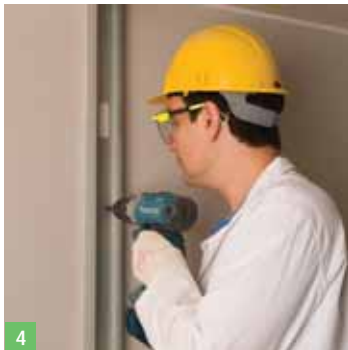

- Locate the first stud, twist into position and fix to the abutting wall at 600mm centres.



- Locate further studs at 600mm centres to a friction fit within the channel sections - this allows for adjustment during boarding. Position the studs so all face the same way.

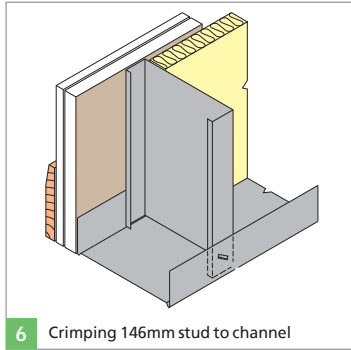

- Where studs are used at heights greater than 4m, consider locking into the floor channels using a Gyproc Crimping Tool, or Gyproc Wafer Head Screws.



- Apply Gyproc Sealant to both sides of the frame perimeters to provide optimum acoustic performance.



Light and Medium Duty door openings

- Locate full height studs each side of the door opening. Fix to the Gypframe Floor & Ceiling Channel at base using Gyproc Wafer Head Drywall Screws or Gyproc Wafer Head Jack-Point Screws, or crimping tool (dependant on the stud type and gauge).



9

- Form the door head from channel section, cut and bend to fit.



10

- Line the opening with timber - 38mm deep x width of stud, and fix through the metal frame into the timber.

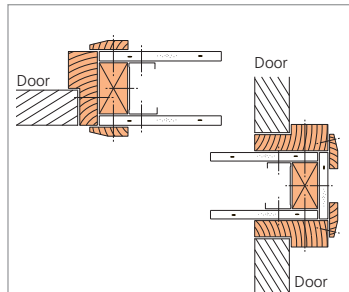

11

Standard door frame to satisfy BS 5234:
Parts 1 & 2: 1982, Light and Medium Duty

- Fix the door casing to the timber ground.
- NB** Advice should be sought from the door manufacturer prior to the construction of these details.

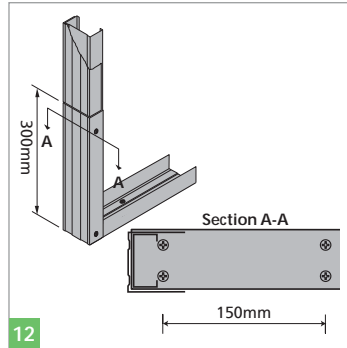

Heavy Duty and Severe Duty door openings

- Sleeve the studs either side of the opening with channel section, stopping 300mm short of the floor channel.

- Allow for extension of floor channel. This is then cut, bent, and interleaved as shown in section A-A, and then fixed twice to each side.



- At the head, cut and bend channel to extend 150mm down the face of the studs, and fix twice to each side of each stud.



Fixtures

- Install Gyprame 99 FC 50 Fixing Channel to accommodate medium weight fixtures.



- Install Gyprame 150 FC 90 Fixing Channel to accommodate heavyweight fixtures. If a plywood pattress is required, Gyprame Service Support Plates should be used.



Services

- Install services (by appropriate trades), normally after one side is boarded. Pass horizontal runs through cut-outs in the studs and install Gyprame 99 FC 50 Fixing Channel or Gyprame Floor & Ceiling Channel between studs to provide support for recessed switch boxes.



- Where plastic clip in socket boxes are being used in fire-rated systems, Hilti CP617 Putty Pads can be used. Contact Hilti for full details, tel: 0800 886 100.
- All performance substantiation has to be provided by the fire-stopping manufacturer as is the case for any fire-stopping material.

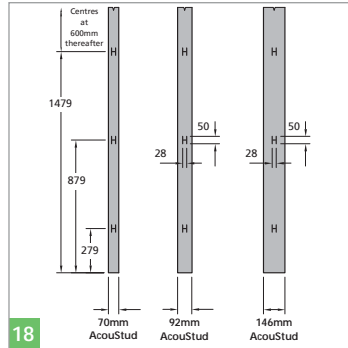

- Fig 18 showing position of Gyproframe AcouStud cut-out.
- The position of cut-outs is the same for each Gyproframe 'C' Stud and Gyproframe 'I' Stud.



Board fixing - single layer

- Fix boards to all framing members at 300mm centres using the appropriate length Gyproc screws.
- Reduce centres to 200mm at external angles.



- Lightly butt boards, inserting screws not closer than 10mm from bound edges and 13mm from cut edges.



- Install Isover insulation or stone wool (as required) progressively as boarding proceeds.
- Isover insulation can be hung within the partition by trapping at the partition head using Gypframe Steel Angle.



- Where door openings occur, cut boards around the opening to avoid a joint directly in line with door jambs.

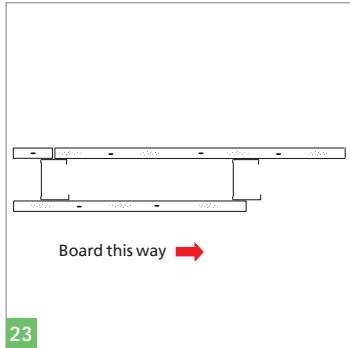

- Adjust studs as boarding proceeds and stagger board joints relative to the opposite side.
- Board partition in the direction of stud flanges as shown above.



Board fixing - multi-layer

- Under-layer boards do not require centre fixings. Cut and fix the initial second layer board as appropriate so that subsequent board joints are staggered.
- Fix outer layer boards to all framing members at 300mm centres using appropriate length Gyproc screws. Reduce centres to 200mm at external angles.

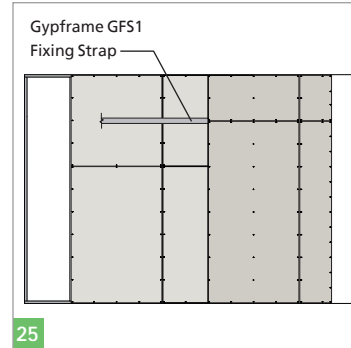

- Typical double layer board configuration is as above.
- If Gyproc Plank forms the base layer, fix horizontally with two 32mm Gyproc Drywall Screws to each stud position, including each cut end. Half stagger end joints in alternate layers.

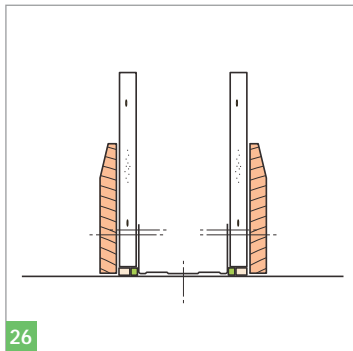

26

- Seal any gaps at the base of linings to both sides with Gyproc Sealant (in conjunction with Gyproc Joint Filler) where the partition is required to meet its optimum acoustic performance.

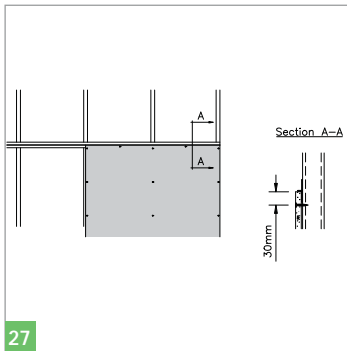

27

Horizontal joint support - single layer

- Where the partition height exceeds the board length, install Gypframe GFT1 Fixing 'T' progressively across studs to coincide with board end joints, to maintain board alignment and to ensure system performance. Fix boards progressively to supports using Gyproc Drywall Screws of appropriate length.



28

NB It is important that boards are levelled on their top edge. Position the top screw into the stud nominally 30mm down to allow the Gypframe GFT1 Fixing 'T' to be installed. Lightly butt and lift boards to the Gypframe GFT1 Fixing 'T' as work progresses. Position the next lift of boards to sit on the Gypframe GFT1 Fixing 'T'.



Horizontal joint support - multi-layer

- Where the partition height exceeds the board length, install Gyproframe GFS1 Fixing Strap progressively between board layers, to coincide with outer layer horizontal board end joints, to maintain board alignment and to ensure system performance.
- Fix boards progressively to supports using Gyproc Drywall Screws of appropriate length.



Splicing studs

- To extend studs, overlap by 600mm (minimum). Fix together using Gyproc Wafer Head Drywall Screws or steel pop rivets (two to each flange), or by using the Gyproc Stud Interlocking Tool twice to each flange.



Boxing studs

- Nest studs with minimum half overlap, allowing for an off-set at head and base to facilitate normal engagement into channels. Lock together at 600mm centres using a Gyproc Stud Interlocking Tool or Gyproc Wafer Head Drywall Screws, at 600mm centres on each flange.
- NB** Gyproc Stud Interlocking tool is not recommended for partition heights above 6 metres.

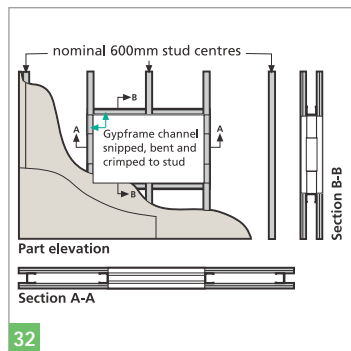

Large service openings

- Construct a framed opening, as shown above.

NB In fire-rated partitions, the service penetration should be fire-stopped, as specified by the appropriate contractor.

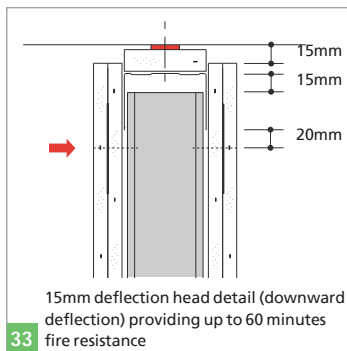

Deflection head

- Form the firestop at the head using Gyproc Plank with continuous line of Gyproc FireStrip. Gypframe Deep Flange Floor & Ceiling Channel is fixed through firestop to soffit at 600mm centres using suitable fixings. No fixings should be made through the boards into the flanges of the head channel. The arrow (→) denotes the position of the uppermost board fixing, which should be made into Gypframe GFS1 Fixing Strap or Gypframe stud nogging, ensuring the downward movement of the head channel is not impaired.

- Alternative deflection head details are available. Contact British Gypsum Drywall Academy Technical Advice Centre.

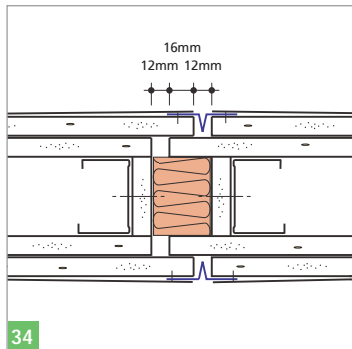

Control joints

- Install as specified to relieve stress / movement and to coincide with movement joints in the external structure.
- Gyproc Control Joint may be cut with a fine-tooth saw. Butt-end joints should be aligned accurately to provide a neat fit. Place the Gyproc Control Joint into position and secure to the Gyproc plasterboard with 13mm corrosion resistant staples at 150mm maximum centres through both flanges.

Ensure the Gyproc Control Joint is cut to a neat fit at the structural floor and soffit or ceiling perimeters and the ends sealed with Gyproc Sealant.

Junction details

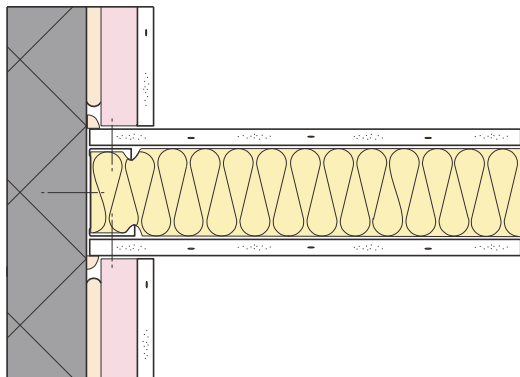

35 Abutment to external wall lined with Gyproc ThermaLine boards

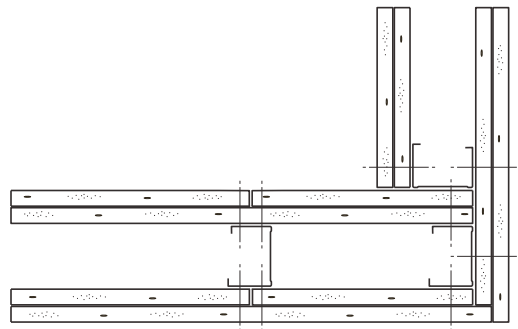

36 Corner detail - double layer

Junction details

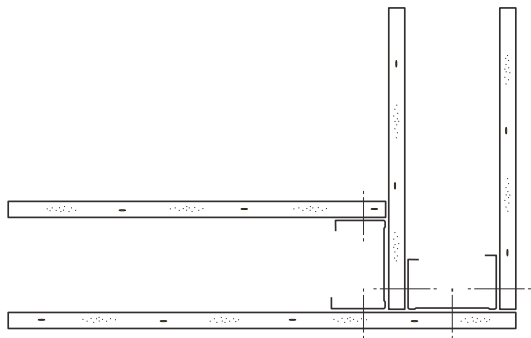

37 Corner detail - single layer

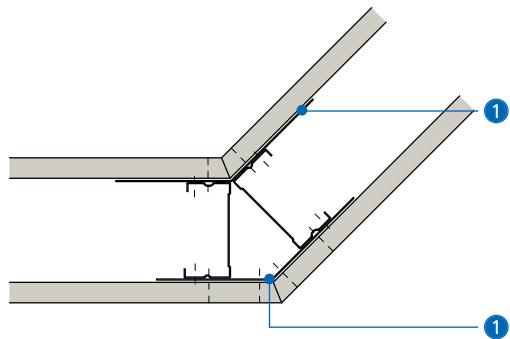

38 Splayed corner

1 Gypframe GA6 Splayed Angle

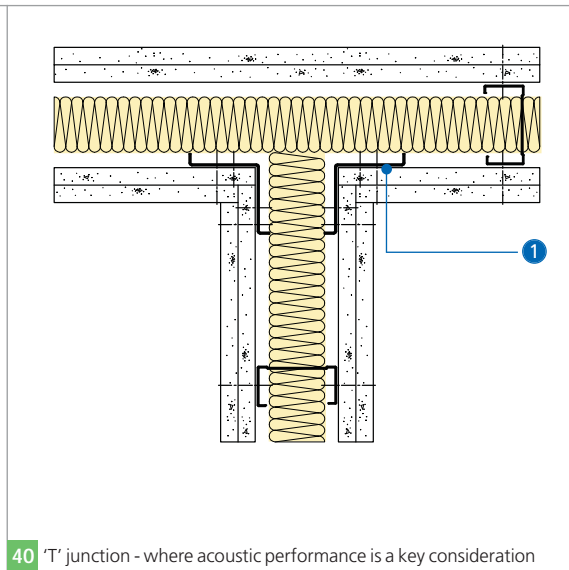
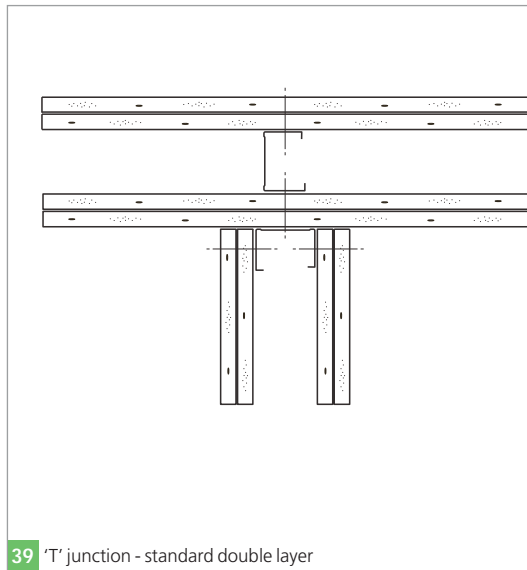

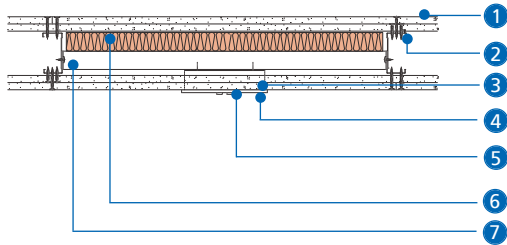

41 Socket box installation - up to 120 minutes fire resistance

- 1** Gyproc plasterboard
- 2** Gypframe 70 S 50 'C' Studs at 600mm centres
- 3** Plasterboard cut to allow a close fitting entry for the socket box
- 4** Gyproc Sealant at switch box perimeter for improved acoustics
- 5** Electrical socket with metal back box
- 6** Stone mineral wool (minimum 80kg/m³) backing to socket box
- 7** Gypframe 72 C 50 Standard Floor & Ceiling Channel receiving fixing of socket box - channel legs tabbed, bent and fixed to metal studs with Gyproc Wafer Head Drywall Screws

GypWall EXTREME

Ultimate impact and abrasion resistant partition system

GypWall EXTREME is British Gypsum's ultimate impact resistant partition system for use where extra durability is required above and beyond Severe Duty.

GypWall EXTREME is designed specifically to cope with the rigours of intensive high traffic use in commercial applications.

GypWall EXTREME combines Gyproc plasterboards and Rigidur H advanced fibre reinforced gypsum board to create a lightweight, cost-effective solution both in terms of construction and lifetime costs. **GypWall EXTREME** is fully adaptable and compatible with other British Gypsum systems, offering the potential to fully value engineer your project.

Additional time should be allowed for the cutting, handling and fixing of Rigidur H compared to standard Gyproc plasterboard.



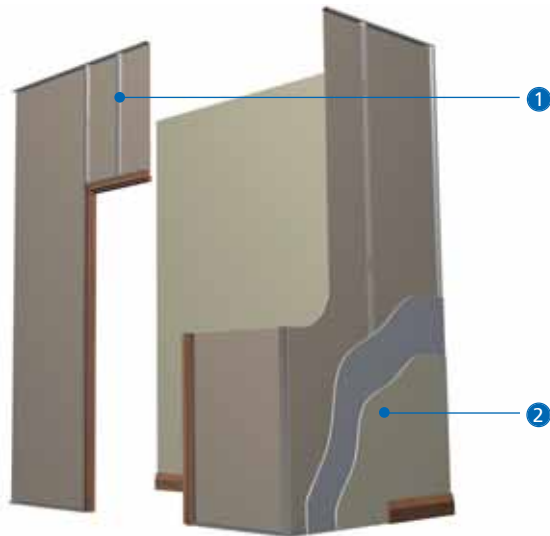



- 1 Gypframe AcouStud
- 2 Rigidur H

Key facts

- Tested above and beyond the performance requirements of *BS 5234: Part 2: 1992 Severe Duty*
- Capable of securing heavy fixings on a single layer without the need for additional pattrassing¹
- Extremely durable and resilient linings
- Excellent resistance to vandalism
- Reduces cost of repair – ideal for PFI maintenance agreements
- Excellent acoustic performance – achieves up to 52dB in single layer system on standard Gypframe 'C' Studs
- Extremely cost effective system compared to other fibre board offerings due to the use of inner layer Gyproc plasterboards

¹ Dependant upon fixing and geometry of the object.

Components**Gypframe metal products**

			Take-off quantities¹
	70 S 60 'C' Stud Length	3600, 4200mm	167m
	70 AS 50 AcouStud Length	2400, 2700, 3000, 3600, 4200mm	167m
	146 S 50 'C' Stud (for door details) Length	3000, 3600, 4200mm	as required
	146 AS 50 AcouStud Length	2700, 3000, 3600mm	167m
	Deep Flange Floor & Ceiling Channel 72 DC 60, 148 DC 60 Extra Deep Flange Floor & Ceiling Channel 72 EDC 80, 148 EDC 80 All channels are available in 3600mm only.		Dependant on partition length

¹ Quantities are for 100m² of straight partition boarded with a double layer of board each side. Quantities are approximate and for guidance only, no allowance has been made for waste, openings, abutments, etc.





Gypframe metal products

			Take-off quantities¹
	99 FC 50 Fixing Channel Length	2400mm	as required
	150 FC 90 Fixing Channel Length	1194mm	as required
	GFS1 Fixing Strap Length	2400mm	as required
	GFT1 Fixing 'T' Length	2400mm	as required

Board products

	Rigidur H Thickness	12.5, 15mm	200m ² per layer
	Width	1200	

² Moisture resistant boards are specified in intermittent wet use areas e.g. shower cubicles.

Board products – inner layer options (cont'd)		Take-off quantities ¹
	<p>Gyproc SoundBloc² Thickness 12.5, 15mm Width 1200</p>	200m ² per layer
Fixing and finishing products		
	<p>Gyproc Drywall Screws For fixing boards to stud framing up to 0.79mm thick.</p>	1 st layer - 1750
	<p>Gyproc Wafer Head Drywall Screws For metal-to-metal fixing up to 0.79mm thick.</p>	as required
	<p>Rigidur Screws For fixing Rigidur H to Gypframe metal (available in 30mm or 40mm).</p>	Single or 2 nd layer - 2250
	<p>Gyproc Sealant For sealing airpaths for optimum sound insulation.</p>	1 cartridge per 35m based on a 6-10mm bead
	<p>Gyproc jointing materials For a seamless finish.</p>	as required

Fixing and finishing products		Take-off quantities ¹
	<p>Gyproc edge beads Protecting and enhancing board edges.</p>	as required
	<p>Gyproc Control Joint To accommodate structural movement.</p>	as required
	<p>Gyproc FireStrip For sealing deflection heads.</p>	as required
	<p>Thistle Multi-Finish, Thistle Board Finish or Thistle Durafinish Providing a plaster finish.</p>	10m ² per 25kg bag
	<p>Thistle Spray Finish Gypsum finish plaster for spray or hand application.</p>	11m ² per 25kg bag
	<p>Isover APR 1200 For enhanced acoustic performance.</p>	100m ² where specified
	<p>Isover ULTIMATE Piano Plus 60mm thick, for improved acoustic performance and fire insulation.</p>	100m ² where specified

Construction tips for GypWall partitions

- Estimated construction time 1.5m² - 2m² / man hour (single layer partition) or 1m² - 1.5m² / man hour (double layer partition) ready for finishing
- Use full height boards wherever possible - if horizontal joints are unavoidable, endeavour to position them above the suspended ceiling or below access floor level. Avoid eyeline and strong wall lighting areas
- Fixtures / fittings - additional framing will be required to support heavyweight items (e.g. sanitary ware)
- Support horizontal joints with Gypframe GFT1 Fixing 'T', Gypframe GFS1 Fixing Strap or Gypframe 99 FC 50 Fixing Channel (where specified)
- Install Gyproc Control Joints where specified
- Incorporate deflection heads where specified
- Consider skirting fixing - mechanical or using Gyproc Sealant
- If doorsets are fixed at a later stage allow a 10mm overall tolerance in width, 5mm in height
- Consider additional door detailing to BS 5234
- Single layer Rigidur H should be fixed to Gypframe 70 S 60 'C' Studs. Double layers should be fixed to Gypframe 70 AS 50 AcouStuds or Gypframe 146 AS 50 AcouStuds

Construction recommendations specific to GypWall EXTREME

Handling - due to the density of Rigidur H, additional time and equipment is required. This needs to be factored into installation costs.

Table 1

Board type	Board thickness mm	Board width mm	Board length mm	Board weight kg
Rigidur H	12.5	1200	2400	43
	12.5	1200	2800	50
	12.5	1200	3000	54
Rigidur H	15	1200	2400	52
	15	1200	2800	61
	15	1200	3000	65

Please consider the board weights before handling the board and use mechanical handling equipment where necessary. Only lift what you feel you can manage and use the tips below to reduce board handling:

- Always position the pallet of boards as close to the construction as possible to avoid prolonged lifting
- Cut the boards on the stack to further reduce handling
- Cuts for doorways and window details can be made on the stack using a hand held circular saw

NB The information in this document is provided in good faith, as a guide to good practice. It should be used in addition to, and not as a replacement for, the normal processes of on-site assessment and site safety management.

Information is also included over the following two pages on specialist handling equipment, as featured within the Gyproc Tools catalogue, available from the Artex website, www.artextld.com

Board handling equipment

The Gyproc Tools specialist range of plasterboard handling equipment has been specifically designed to minimise manual handling of board products and therefore increase safety and efficiency on-site. For more information, please visit the Artex website, www.artextld.com

G-In Lift Rack

Used to hoist plasterboard from delivery vehicle to required destination.

Order Code: 19553



G-In Lift Truck

Used to transport plasterboard to place of installation.

Order Code: 19550



G-In Trestle

Foldable supports providing a working load capacity of 400kg per trestle.

Order Code: 19552



G-In Transit Bench

A combined workbench and board transporter.

Order Code: 19551



G-In Branch Rack

Suitable for storing strip components off ground, avoiding damage and trips. Ideal for metal stud components.

Order Code: 19554



Gyproc Jackal

Trigger grip board lifter.

Order Code: 19409



Gyproc Drywall Cart

A transporter with a removeable vertical support bar.

Order Code: 15292



Gyproc Footlifter

Used for jacking boards into position.

Order Code: 60381



Gyproc Steel WallBoard Carriers

The pair of steel carriers allows for easy and safe movement of plasterboard.

Order Code: 15398



Construction recommendations specific to GypWall EXTREME

Cutting - due to the high density and hardness of Rigidur H, it is not as easy to score and snap as standard plasterboard, and the use of a hand saw may be required.

- Power tools are required to cut large volumes of the board
- Best practice is to use a hand held circular saw with suitable dust extraction system. Use a fine saw blade with a high ratio of teeth
- Complex details (doors and sockets) will take more time to cut out. It is recommended that a jigsaw or 110 volt rotary cutter is used. Curves can be achieved using a fret saw



Construction recommendations specific to GypWall EXTREME

Fixing - additional time will be required to fix Rigidur H due to its density.

- Always use a mains powered 110 volt screw gun
- Always work from the bottom of the stud up when fixing Rigidur H, as per best site practice
- Pre-drilling the first screws at the base of the partition will aid fixing
- Consider clamping the board to the stud using a g-clamp

Finishing

- Some burring is expected around the screw head. It may be necessary to use a surform or sandpaper to clean prior to finishing
- For information on jointing and plastering Rigidur H please refer to the data sheet - 'Rigidur H for commercial applications', available to download from www.british-gypsum.com

Installation



- Determine and mark the wall position and make allowance for openings.
- Fix Gypframe Deep Flange Floor & Ceiling Channel along the centre line to the floor and ceiling at 600mm centres with suitable fixings.
- On uneven floors, a timber sole plate, 38mm deep x width of stud, may be required.
- On new concrete or screeding, consider installing a damp proof membrane to the full partition width before locating the floor channel or sole plate.



- 148mm channels require two rows of staggered fixings (600mm centres in each row).
- For partitions above 8 metres, Gypframe Extra Deep Flange Floor & Ceiling Channel (EDC) should be used at the head and base.



- Cut studs to a neat fit (maximum possible entry into head channel).
- NB** Cut studs to size using a chop saw, hacksaw or snips.



- Locate the first stud, twist into position and fix into the abutting wall at 600mm centres.



- Locate further studs at 600mm centres to a friction fit within the channel section - this allows for adjustment during boarding. Position the studs so all face the same way.

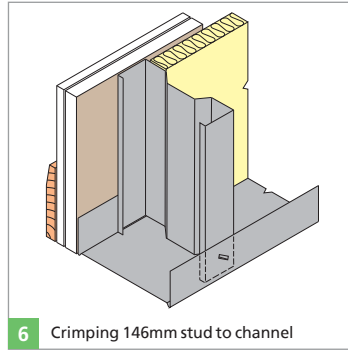

- Where studs are used at heights greater than 4 metres, consider locking into the floor channels using a Gyproc crimping tool, or Gyproc Wafer Head Screws.



- Apply Gyproc Sealant to both sides of the frame perimeters to provide optimum acoustic performance.

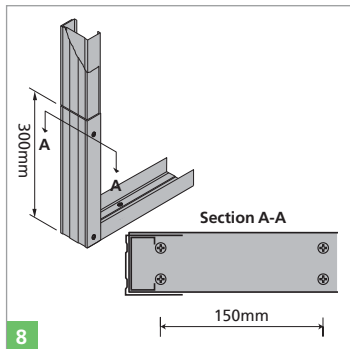

8

- Locate full height studs each side of the door opening, sleeve the studs either side of the opening with channel section, stopping 300mm short of the floor channel.
- Allow for extension of floor channel. This is then cut, bent, and interleaved as shown in section A-A above, and then fixed twice to each side.



9

- At the head, cut and bend channel to extend 150mm down the face of the stud, and fix twice to each side of each stud.



10

Services

- Install services (by appropriate trades), normally after one side is boarded. Pass horizontal runs through cut-outs in the studs and install Gypframe 99 FC 50 Fixing Channel or Gypframe Floor & Ceiling Channel between studs to provide support for recessed switch boxes.



- Where plastic clip-in socket boxes are being used in fire-rated systems, Hilti CP617 Putty Pads can be used. Contact Hilti for full details, tel: 0800 886100.
- Sockets will take more time to cut out. Drill four holes corresponding with the corners of the socket box and then cut out using a jigsaw.
- All performance substantiation has to be provided by the fire-stopping manufacturer as is the case for any fire-stopping material.

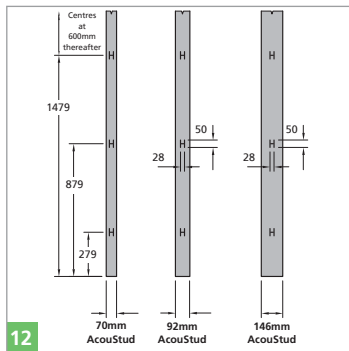

- Fig 12 showing position of Gyframe AcouStud cut-out.
- The position of cut-outs is the same for each Gyframe 'C' Stud and Gyframe 'I' Stud.



Board fixing - single layer

- Fix Rigidur H boards to all framing members at 300mm centres using Rigidur Screws.
- Reduce centres to 200mm at external angles.
- Always begin fixing from the bottom upwards.
- Due to the high density and hardness of Rigidur H, some burring around the screw heads can be expected. Additional time should be allowed for cleaning off, before finishing with a small surform (or sand paper).



14

● Lightly butt boards, inserting screws not closer than 13mm from edges (as with non-bound plasterboard edges).

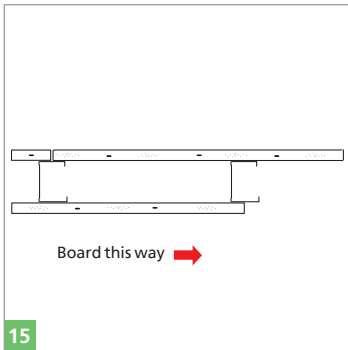

15

Board this way →

- Adjust studs as boarding proceeds and stagger board joints relative to the opposite side.
- Board partition in the direction of stud flanges, as shown above, to reduce the risk of studs twisting during installation.



16

Board fixing - double layer

- Inner layers of Gyproc plasterboard should be fixed with 25mm Gyproc Drywall Screws around the perimeter of the board at 300mm centres, and at the intermediate stud at 600mm centres.
- Cut and fix the initial second layer board as appropriate so that subsequent board joints are staggered.

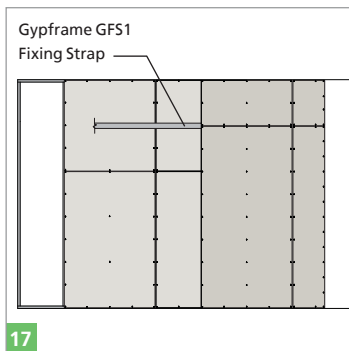

- Typical double layer board configuration is as above.

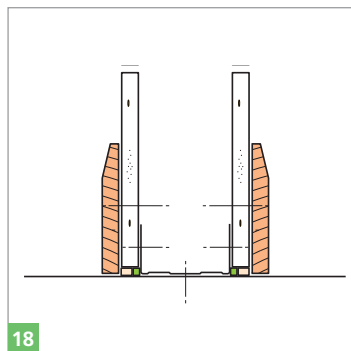

- Seal any gaps at the base of linings to both sides with Gyproc Sealant (in conjunction with Gyproc Joint Filler) where the partition is required to meet its optimum acoustic performance.

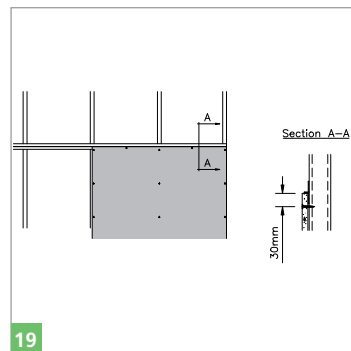

- Where the partition height exceeds the board lengths, install Gypframe GFT 1 Fixing 'T' progressively between studs to coincide with board end joints, to maintain board alignment. Fix boards to supports using 40mm Rigidur Screws.
- It is important that boards are levelled on their top edge. Position the top screw into the stud nominally 30mm down to allow the Gypframe GFT1 Fixing 'T' to be installed. Lightly butt and lift boards to the Gypframe GFT1 Fixing 'T' as work progresses. Position the next lift of boards to sit on the Gypframe GFT1 Fixing 'T'.



Horizontal joint support - multi-layer

- Where the partition height exceeds the board length, install Gypframe GFS1 Fixing Strap progressively between board layers, to coincide with outer layer horizontal board end joints, to maintain board alignment.
- Fix boards to supports using Rigidur Screws.



Splicing studs

- To extend studs, overlap by 600mm (minimum). Fix together using Gyproc Wafer Head Drywall Screws or steel pop rivets (two to each flange), or by using the Gyproc Stud Interlocking Tool twice to each flange.



Boxing studs

- Nest studs with minimum half overlap, allowing for an off-set at head and base to facilitate normal engagement into channels. Lock together at 600mm centres using a Gyproc Stud Interlocking Tool or Gyproc Wafer Head Drywall Screws, at 600mm centres on each flange.

NB Gyproc Stud Interlocking Tool is not recommended for partition heights above 6 metres.

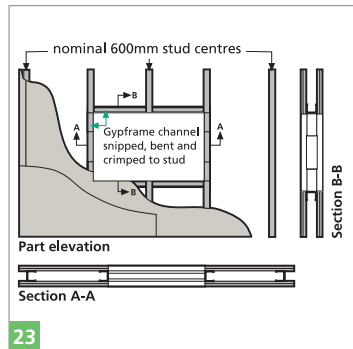

Large service openings

- Construct a framed opening, as shown above.

In fire-rated partitions, the service penetration should be fire-stopped, as specified by the appropriate contractor.

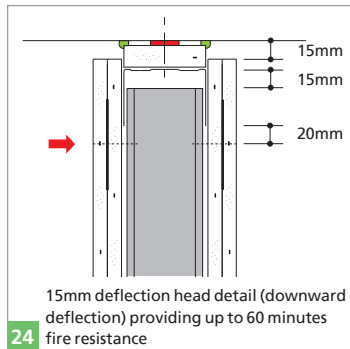

Deflection head

- Form the firestop at the head using Gyproc Plank with continuous line of Gyproc FireStrip. Gypframe Deep Flange Floor & Ceiling Channel is fixed through firestop to soffit at 600mm centres using suitable fixings. No fixings should be made through the boards into the flanges of the head channel.

- The arrow (→) denotes the position of the uppermost board fixing, which should be made into Gypframe GFS1 Fixing Strap or Gypframe stud nogging, ensuring the downward movement of the head channel is not impaired.
- Alternative deflection head details are available. Contact the British Gypsum Drywall Academy.

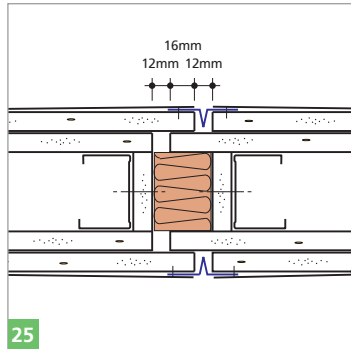

Control joints

- Install as specified to relieve stress / movement and to coincide with movement joints in the external structure.
- Gyproc Control Joint may be cut with a fine-tooth saw. Butt-end joints should be aligned accurately to provide a neat fit. Place the Gyproc Control Joint into position and secure to the Gyproc plasterboard with 13mm corrosion resistant staples at 150mm maximum centres through both flanges.
- Ensure the Gyproc Control Joint is cut to a neat fit at the structural floor and soffit or ceiling perimeters and the ends sealed with Gyproc Sealant.

Junction details

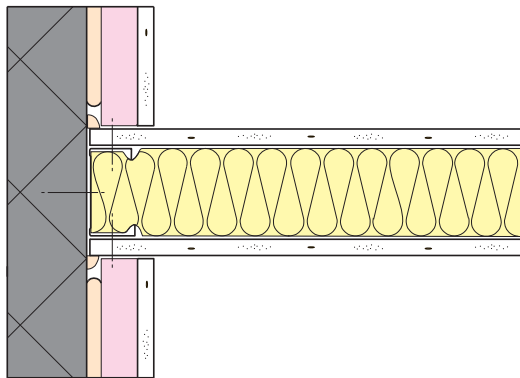

26 Abutment to external wall lined with Gyproc ThermaLine boards

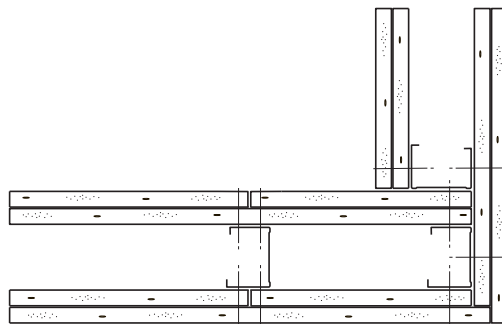

27 Corner detail - double layer

Junction details

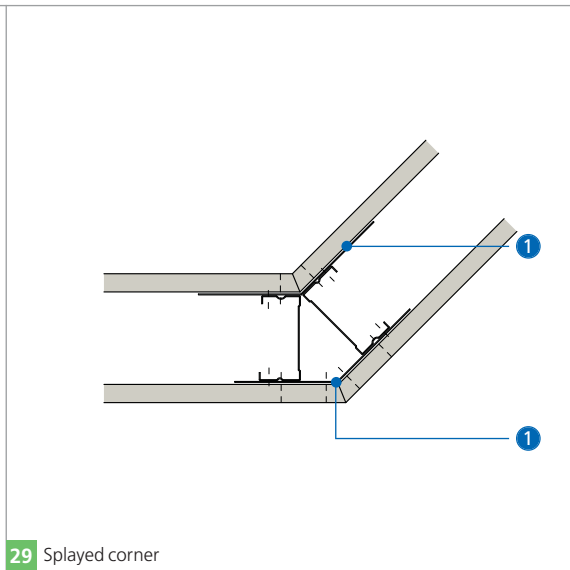
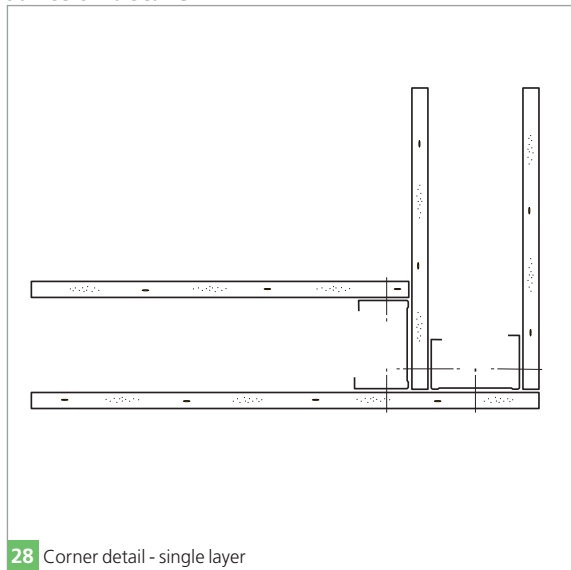

1 Gypframe GA6 Splayed Angle

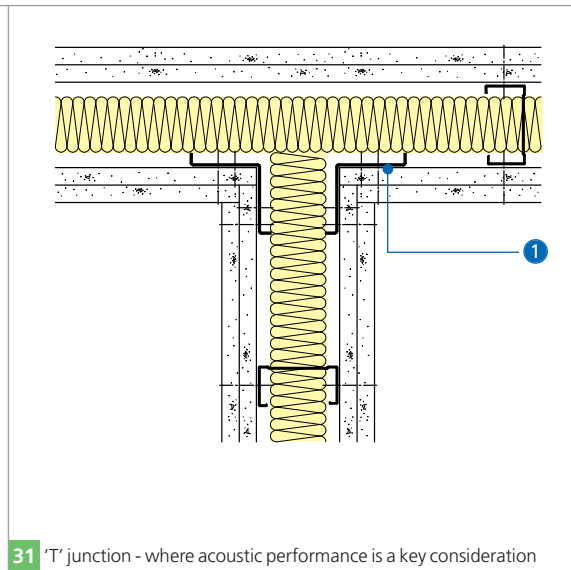
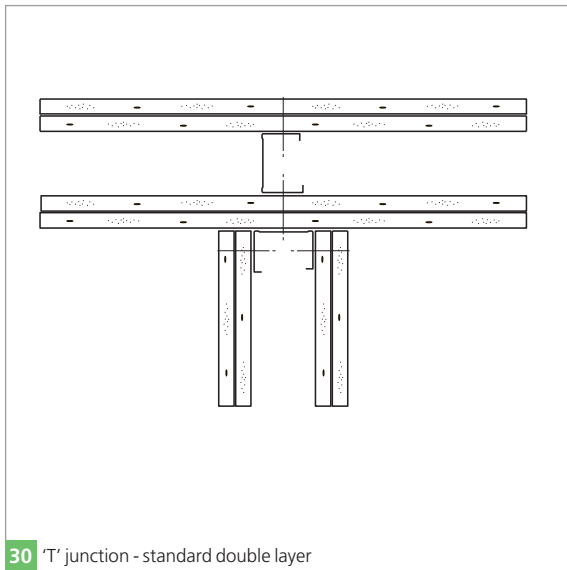

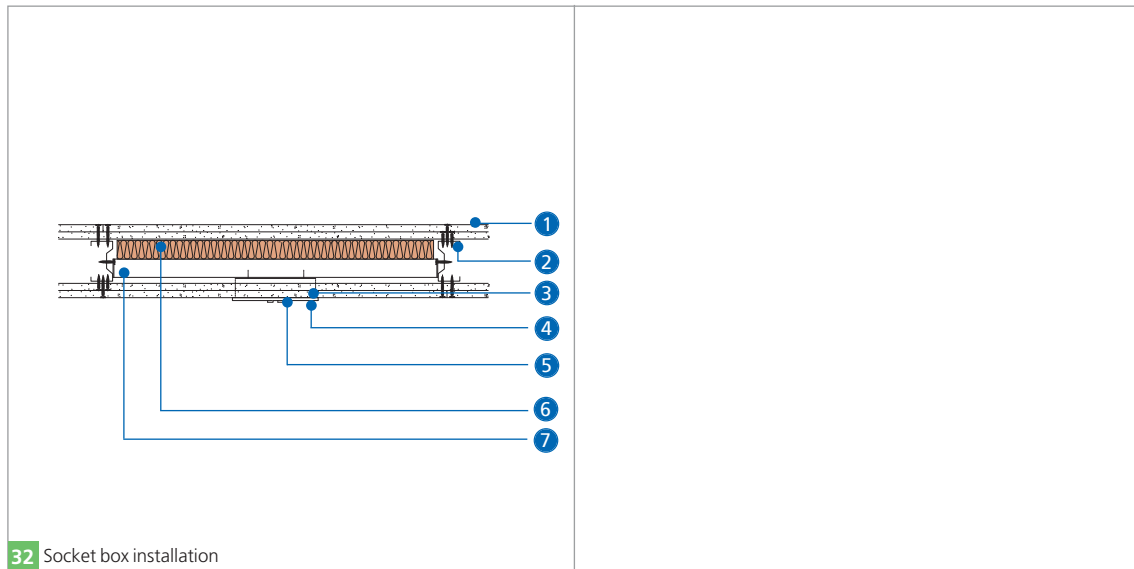

32 Socket box installation

- 1 Rigidur H
- 2 Gypframe 70 AS 50 AcouStuds at 600mm centres
- 3 Lining boards cut to allow a close fitting entry for the socket box
- 4 Gyproc Sealant at switch box perimeter for improved acoustics
- 5 Electrical socket with metal back box
- 6 Stone mineral wool (minimum 80kg/m³) backing to socket box
- 7 Gyproframe 72 DC 60 Deep Flange Floor & Ceiling Channel receiving fixing of socket box - channel legs tabbed, bent and fixed to metal studs with Gyproc Wafer Head Drywall Screws

Curved partition system

GypWall CURVE is lightweight, non-loadbearing and easily assembled on site. It provides a highly cost-effective way of forming curved walls and linings. The system can be installed in all types of buildings to achieve the radii required by the designer. Boards do not require pre-wetting and there is no requirement for curved timber templates.



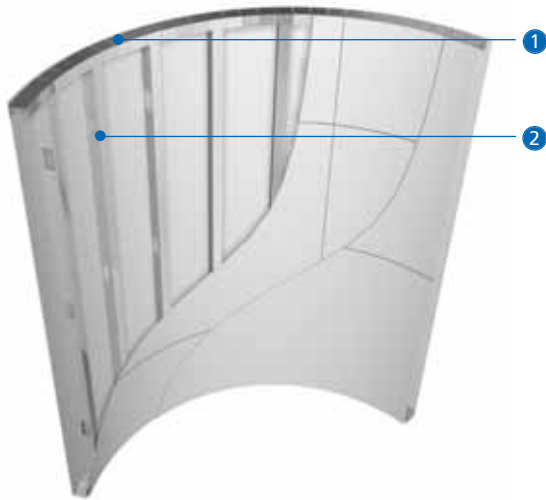





- 1 Gypframe 72 EDCL 80 CurveLiner Channel
- 2 Gypframe 70mm 'C' Stud or Gypframe 70mm 'I' Stud

Key facts



- 1 Concave or convex curvature
- 1 Minimum radii 600mm
- 1 Uniquely designed channel can be quickly and easily bent to radius
- 1 No requirement for pre-wetting boards
- 1 No need for curved timber templates
- 1 Choice of linings to suit performance requirements and to maintain continuity
- 1 Boards can be jointed or skimmed in the normal way

Components



Gyproc and Glasroc board products

			Take-off quantities ¹
	Gyproc WallBoard² Thickness 9.5, 12.5, 15mm Width 1200mm		200m ² per layer
	Gyproc SoundBloc² Thickness 12.5, 15mm Width 1200mm		200m ² per layer
	Gyproc SoundBloc F Thickness 15mm Width 1200mm		200m ² per layer
	Gyproc FireLine² Thickness 12.5, 15mm Width 1200mm		200m ² per layer
	Gyproc DuraLine³ Thickness 15mm Width 1200mm		200m ² per layer

¹ Quantities are for 100m² of partition run, boarded with a double layer of board each side, with studs at 300mm centres. Quantities are approximate and for guidance only, no allowance has been made for waste, openings, abutments, etc.









			Take-off quantities ¹
	Glasroc F MULTIBOARD³ Thickness 6, 10, 12.5mm Width 1200mm		200m ² per layer
	Glasroc H TILEBACKER³ Thickness 6mm Width 1200mm		200m ² per layer

Gypframe metal products

	Gypframe 'C' Studs Width 70mm Length 2400 - 4200mm Codes 70 S 50, 70 S 60		335m
	Gypframe 'I' Studs Width 70mm Length 3600 and 4200mm Codes 70 I 50, 70 I 70		335m

² Moisture resistant boards are specified in intermittent wet use areas e.g. shower cubicles

³ 6mm Glasroc F MULTIBOARD and 6mm Glasroc H TILEBACKER is recommended for most curved partition applications.

	Take-off quantities ¹		Take-off quantities ¹
 <p>Gypframe CurveLiner Channel Width 72mm Length 2000mm Code 72 EDCL 80</p>	Dependent on length of partition	 <p>Gyproc Sealant For sealing airpaths for optimum sound insulation.</p>	1 cartridge per 35m based on 6-10mm bead
Fixing and finishing products			
 <p>Gyproc Drywall Screws For fixing boards to stud framing up to 0.79mm thick.</p>	1 st layer - 3750 2 nd layer - 3750	 <p>Gyproc Drywall Primer Used to prepare for painting. Tub contents 10 litre</p>	20 litres where specified
		or	
 <p>Gyproc Jack-Point Screws For fixing boards to stud framing 0.8mm thick or greater and 'I' studs greater than 0.55mm thick.</p>	1 st layer - 3750 2 nd layer - 3750	 <p>Gyproc Drywall Sealer Used to provide vapour control. Tub contents 10 litre</p>	30 litres where specified
 <p>Gyproc Wafer Head Jack-Point Screws For metal-to-metal fixing 0.8mm thick or greater.</p>	as required	 <p>Gyproc jointing materials For seamless jointing.</p>	as required

¹ Quantities are for 100m² of partition run, boarded with a double layer of board each side, with studs at 300mm centres. Quantities are approximate and for guidance only, no allowance has been made for waste, openings, abutments, etc.

² Moisture resistant boards are specified in intermittent wet use areas e.g. shower cubicles

³ 6mm Glasroc F MULTIBOARD and 6mm Glasroc H TILEBACKER is recommended for most curved partition applications.

Fixing and finishing products



**Thistle Multi-Finish or
Thistle Board Finish**
To provide a plaster skim finish.

or



Thistle Durafinish
To provide improved resistance to
accidental damage.

or



Thistle Spray Finish
Gypsum finish plaster for spray or
hand application.

Take-off
quantities¹

10m² per
25kg bag

10m² per
25kg bag

11m² per
25kg bag

¹ Quantities are for 100m² of partition run, boarded with a double layer of board each side, with studs at 300mm centres. Quantities are approximate and for guidance only, no allowance has been made for waste, openings, abutments, etc.

² Concave or convex.

³ For any radius 7m or more, studs can be installed at 600mm centres irrespective of board type.

Table 1

Board type	Thickness mm	Minimum radius ² mm	Stud centres ³ mm
Glasroc F MULTIBOARD	6	600	300
	10	2500	300
	12 (2 x 6)	600	300
	12.5	2700	300
Gyproc WallBoard	9.5	1800	300
	12.5	3600	300
	15	4800	300
Gyproc FireLine	12.5	4800	300
	15	5700	400
Gyproc SoundBloc	12.5	2900	300
	15	3600	300
Gyproc SoundBloc F	15	5700	400
Gyproc DuraLine	15	5700	400
Glasroc H TILEBACKER	6	600	300

Construction tips

- 1 The following points should be considered in addition to the construction tips for **GypWall CLASSIC**
- 1 Estimated construction time $2\text{m}^2 - 3\text{m}^2$ / man hour (single layer partition) or $1.5\text{m}^2 - 2\text{m}^2$ / man hour (double layer partition) ready for finishing
- 1 Avoid positioning board joints on the exposed board layers on the apex of a convex curve. The positioning of all studs, therefore, needs to be determined at the design stage
- 1 Where straight sections occur on runs of curved partitions or linings, stud centres can be increased to 600mm, once 600mm off the curve
- 1 In common with other sheet materials, board ends have a tendency to remain straight, and so the minimum radius will be influenced by the board characteristics, the length of curve, the support centres, and the occurrence of board joints

Installation



Install **GypWall CURVE** partitions as per **GypWall CLASSIC** with the following exceptions.

- Mark lines on the floor and soffit to the curvature required.



2

- At the floor and soffit, form continuous channel from Gypframe 72 EDCL 80 CurveLiner Channel.
- Bend each section to the curvature line and fix through to the structure in two lines at 300mm centres in each line using appropriate fixings.



3

- Locate 70mm Gypframe metal studs into the Gypframe 72 EDCL 80 CurveLiner Channel at 300mm centres. Crimp each stud into the channel at the head and base or fix with Gyproc Wafer Head Jack-Point Screws.
- NB** Where a deflection head is required, adopt the principles shown in section 5 – GypWall CLASSIC and GypWall ROBUST.



4

Board fixing - single layer

- Fix boards horizontally. Stagger board joints and avoid joints occurring on the apex of a convex curve otherwise problems may be encountered when finishing.
- Insert Gyproc Drywall Screws at 300mm centres in the field of the board and 150mm centres at board ends.
- For tight radius partitions the ease of installation can be improved by pre-bending the board.

Board fixing - double layer

- Fix the inner layer board horizontally to all supports at 300mm centres in the field of the board and 150mm centres at board ends. All joints should be staggered.
- Fix outer layer boards horizontally at 300mm centres in the field of the board and 150mm centres at board ends, with joints staggered in relation to the first layer.
- Avoid board joints occurring on the apex of a convex curve in the outer layer.

Additional studs may be required where multiple layers are specified to account for the difference which arises between the inner and outer radii.

Metal stud housing partition system

GypWall RAPID dB Plus is a specialist non-loadbearing Gypframe metal stud internal wall system for use in housing. This versatile system incorporates Gyproc SoundBloc RAPID linings, which provide acoustic solutions to comply with Building Regulations Approved Document E, and also provide fire and impact resistance. The system is quick to build, timber-free, and provides pre-finished service cut-outs. There are two build options – 450mm stud framing without noggings, and 900mm stud framing with horizontal noggings.



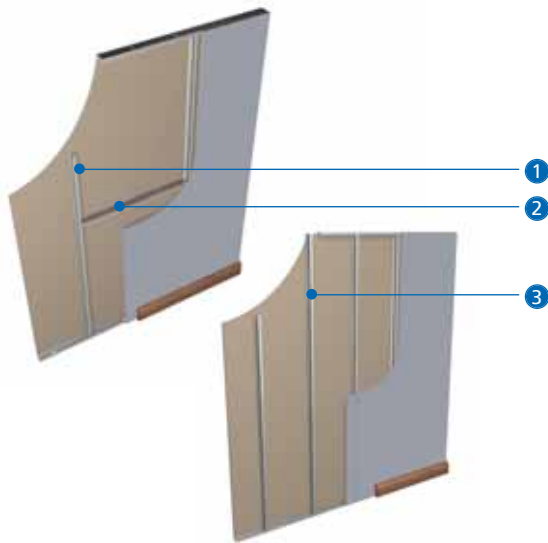

- 1 Swaged Gypframe AcouStud
- 2 Gypframe GWR Noggling Channel
- 3 Gypframe AcouStud

Key facts

- Lightweight, versatile and quick to install
- Achieves the R_w40 dB national Building Regulations Part E requirement
- Choice of 450mm stud centres (without noggings) or 900mm centres (with noggings)
- Fast-track alternative to timber stud
- Satisfies *BS 5234* strength and robustness requirements up to Medium Duty
- 30 minutes fire resistance
- Accommodates services through pre-cut apertures
- Single layer sound-resisting linings
- Quicker board fixing than 'standard' metal and timber stud partitions (fix at 400mm centres)

Components**Gyproc board products****Gyproc SoundBloc RAPID²**

Thickness	15mm
Width	900mm

Take-off quantities¹20m²**Gypframe metal products****RAPID dB Plus studs****Gypframe 43 AS 50 AcouStud (swaged to accommodate mid-height noggings)**

Length	2395, 2695mm
--------	--------------

900mm

centres -

12m

**Gypframe 70 AS 50 AcouStud**

Length	3000, 3600, 4200mm
--------	--------------------

450mm

centres -

24m

Gypframe metal products**Gypframe GWR2 Nogging Channel 43mm**

Length	896mm
--------	-------

Take-off quantities¹

4

if required

**Gypframe GWR3 Floor & Ceiling Channel (45 C 50)**

Length	2400mm
Width	45mm

9m

**Gypframe 72 C 50 Standard Floor & Ceiling Channel**

Length	3600mm
Width	72mm

9m

¹ Quantities are based on 10m² of straight partition run 2400mm high. Quantities are approximate and for guidance only, no allowance has been made for waste, openings, abutments, etc.

² Moisture resistant grade boards are specified in intermittent wet use areas e.g. shower cubicles.

Gypframe metal products (cont'd)		Take-off quantities ¹
	Gypframe GA6 Played Angle Length 240m, 3600m 85 x 85mm	as required
	Gypframe 99 FC 50 Fixing Channel For cross braces. Length 2400mm	as required
Fixing and finishing products		
	Gyproc Wafer Head Drywall Screws	as required
	Gyproc Drywall Screws 32mm	900mm centres - 170 450mm centres - 220

Fixing and finishing products		Take-off quantities ¹
	Gyproc edge and angle beads Protecting and enhancing board edges and corners.	as required
	Gyproc Sealant Sealing airpaths for optimum sound insulation.	1 cartridge per 35m based on 6-10mm bead
	Gyproc jointing materials For a seamless finish.	as required
	Thistle Multi-Finish or Thistle Board Finish To provide a plaster skim finish.	10m ² per 25kg bag
	Thistle Spray Finish Gypsum finish plaster for spray or hand application.	11m ² per 25kg bag
	Isover APR 1200 For enhanced acoustic performance. 25mm.	10m ² where specified

Construction tips

- The estimated construction time is 3m² - 3.5m² / man hour (ready for finishing)
- Plan the partition layout to minimise cutting i.e. 450mm or 900mm stud centres, depending on the specification
- Maximum partition height 2.7m
- To maximise acoustic performance, special attention should be paid to:
 - sealing of airpaths
 - flanking sound via ceiling voids
 - lightweight and ill-fitting doors
 - poorly located electrical sockets and service pipes
- Will accommodate services up to 25mm diameter through cut-outs
- Route only single heating pipes through each cut-out (or fit proprietary pipe restraining clips to keep pipes apart) in order to minimise vibration noise

Construction tips (cont'd)

- Consider a damp proof membrane on new concrete or screeded floors
- Consider timber sole plates where floor is uneven
- Consider skirting fixing - mechanical or using Gyproc Sealant
- Fixtures / fittings - noggings or additional framing will be required to support heavyweight items (e.g. sanitary ware)

Installation

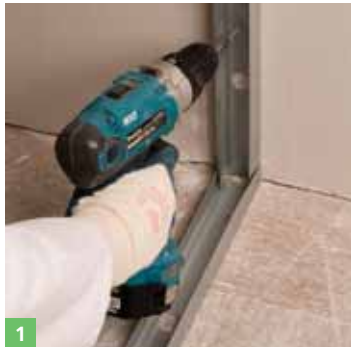

Gypframe studs at 900mm centres with horizontal noggings

- Determine and mark the wall position and make allowance for openings.
- Fix Gypframe Floor & Ceiling Channel along centre line to floor and ceiling and to abutting walls at 600mm centres with suitable fixings.



- Locate vertical Gypframe 43 AS 50 studs into channels at 900mm centres (insert and twist to locate) with single service cut out to the top of wall.
- Cut studs to size using a chop saw, hacksaw or snips.



- Friction fit each noggling end with over-sailing noggling flanges to the outside of the stud.
- Where noggings are cut to fit, engage the cut end into the perimeter channel.
- Locate a Gypframe GWR2 Nogging Channel (for 43mm Gypframe AcouStud) between each pair of studs at mid-height.



NB Noggings are not required at abutments where the horizontal span is less than 600mm.

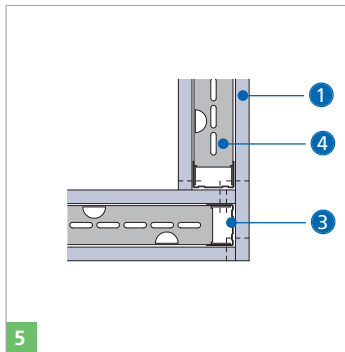

● Form 90° corners as above.

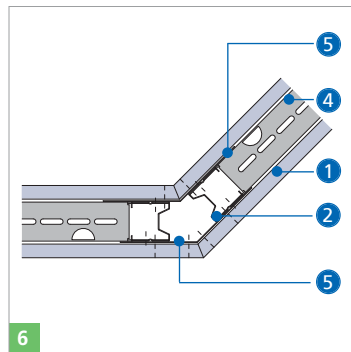

● Form splayed corners using the Gypframe GA6 Splayed Angle (GA6 also required on the inside corner for fire-rated partitions).

- 1 Gyproc SoundBloc RAPID
- 2 Gypframe AcouStud
- 3 Gypframe channel
- 4 Gypframe GWR2 Nogging Channel
- 5 Gypframe GA6 Splayed Angle

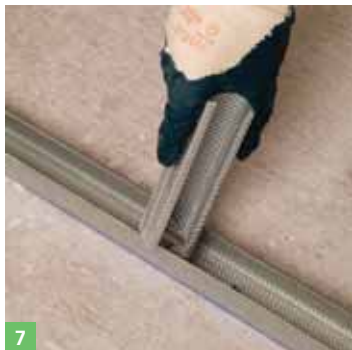

- If required, insert a skirting block into the channel mid-way between each pair of studs to provide a fixing ground for skirting boards, using off-cuts of studs or noggings.
- Apply Gyproc Sealant to frame perimeters (to meet the specified acoustic performance).

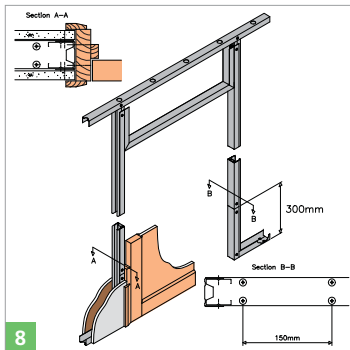

Door openings – standard detailing

- To satisfy a Medium Duty rating, Gyproframe studs are sleeved with a Gyproframe channel to full height either side of the door opening or, alternatively, a timber ground is fitted.
- Cut the floor channel so that it projects 300mm past the door opening at either side.



- Locate the stud to create the door openings into the ceiling channel and floor channel and twist into position.

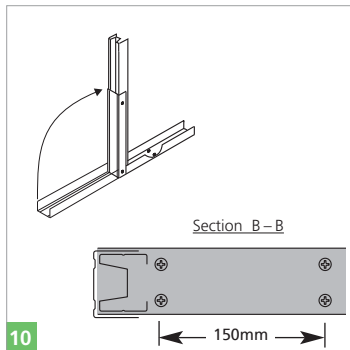

- Cut the flanges of the floor channel, bend it up the face of the Gyproframe 43 AS 50 AcouStud and fix both flanges with Gyproc Wafer Head Drywall Screws.
- Repeat to the other side of opening.

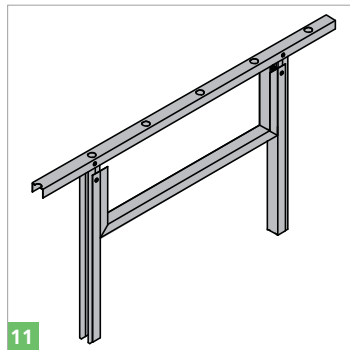

- Fix each stud both sides of the opening to the head channel with a Gyproc Wafer Head Drywall Screw or by crimping.
- Form the door head from Gyproframe GWR3 Floor & Ceiling Channel, cut to a mitre and bend upwards to fit.
- Locate and fix to the studs either side of opening using two Gyproc Wafer Head Drywall Screws. This provides a continuous bearing surface for lining boards in order to maintain fire protection.

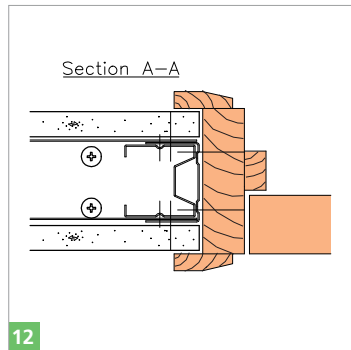

- Fix the door casing to the Gyproframe 43 AS 50 AcouStud framework using suitable fixings.

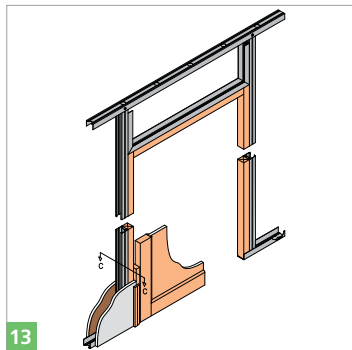

13

Door openings – alternative detail incorporating timber grounds

- Cut the Gypframe Floor & Ceiling Channel to the opening size and set full height stud back approx. 38mm in the channel to enable timber grounds to be installed.
- Form the door head from channel cut to a mitre and bend upwards to fit. Locate and fix to stud either side of opening using **two** Gyproc Wafer Head Drywall Screws. This provides a continuous bearing surface for lining boards.

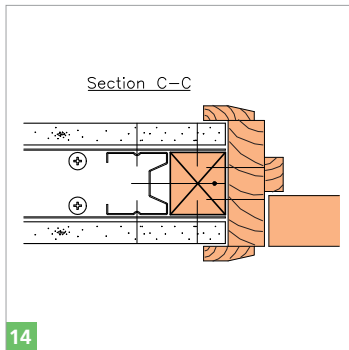

14

- Fix the timber ground (nominally 38mm x width of stud) around the door opening inserting into the floor channel and fix to it.
- (NB)** At this stage the timber ground may be fixed to the stud centrally using a minimum 60mm Gyproc Drywall Screw. Alternatively, fix the timber ground as boarding commences.

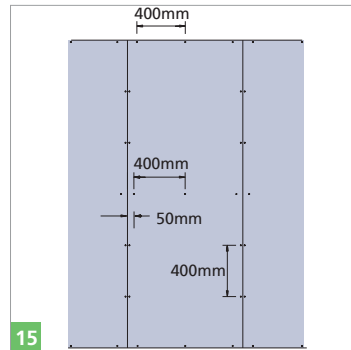

15

Board fixing

- Fix Gyproc SoundBloc RAPID boards to all framing members (including noggings) at 400mm centres using 32mm Gyproc Drywall Screws.
- Reduce centres to 200mm at external angles.
- Lightly butt boards, inserting screws not closer than 10mm from bound edges and 13mm from cut edges.
- Board away from any door openings and fix an infill panel above door heads.



16

- Adjust stud positions as boarding proceeds to allow for board width tolerances.

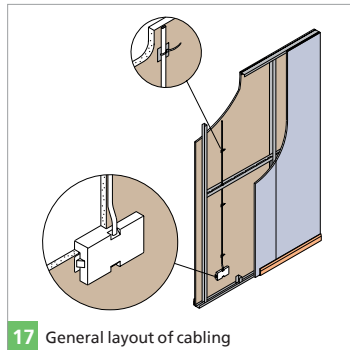

17 General layout of cabling

Installation

- Electrical services should be installed in accordance with I.E.E. Wiring Regulations *BS 7671 Requirements for electrical installers, Regulation 522-06-06*.
- It is normal practice for the Gyproc SoundBloc **RAPID** lining to be erected to only one side of the metal framework initially, to allow services to be installed. This is then followed by the fixing of the board on the other side of the metal framework.

- With framing at 900mm centres, services are passed through the cut-outs in the Gypframe GWR3 Floor & Ceiling Channels and, where necessary, through the cut-outs in the studs and noggings.

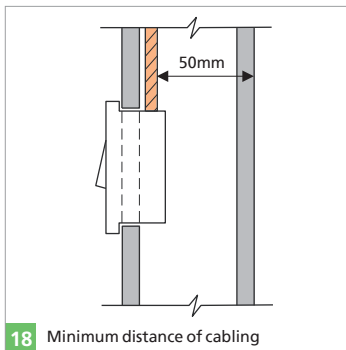

- When framing is at 450mm centres, vertical cabling, between the head and base of the wall, should be fixed to the back face of the Gyproc SoundBloc RAPID, using proprietary clips or other suitable means, where it is necessary to maintain the cover depth of 50mm from the opposite face of the wall.

- Where the location of electrical outlets cannot be determined from the reverse side, then the cable must either be mechanically protected or run at least 50mm from the surface of the wall or partition on the reverse side.

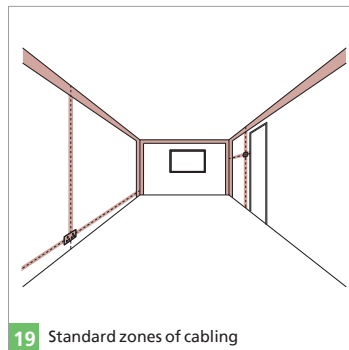

Cables should be installed either:-

- Within 150mm of the top of the wall or partition.
- Within 150mm of the junction between two adjacent walls or partitions.
- Vertically or horizontally from its connection to an electrical point, accessory or switchgear positioned on the wall or partition, in straight runs.

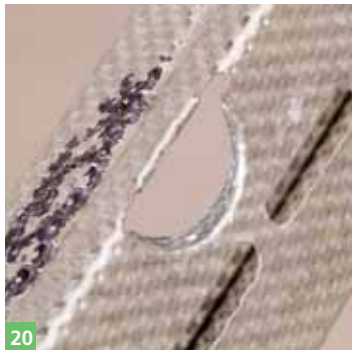

NB The metal framing components have cut-outs which services are routed through. Protect all electrical cables as necessary.

- Switch boxes and socket outlets can be supported on brackets formed from cut and bent channel. The position of the bracket is adjusted according to the depth of the box, taking account of the 15mm board thickness. Screw-fix the bracket at each end. Alternatively, timber fixing pads or noggings can be used.

Service ducts

- Where a large number of electrical cables or pipes have to be accommodated, a service duct can be created by closing the stud centres to 450mm and omitting the intermediate nogging.

Heating pipes

- Where heating pipes are to be located within the **GypWall** system, it is recommended that only one pipe is passed through each aperture in the metal framework.

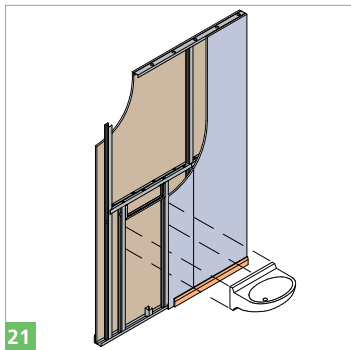

21

- Install Gypframe GWR2 Nogging Channel or additional stud framing as required, to support heavy fixtures.



22

Insulation

- Where specified, locate Isover APR 1200 into the cavity above and below the noggings. Install insulation progressively as boarding proceeds and hold in place using the preferred site method.



23

Installation - Gypframe studs at 450mm centres with no horizontal noggings

Follow previous installation procedure with the following exceptions.

- Studs are located at 450mm centres.
- Horizontal noggings are **not** required.
- Skirting blocks are **not** required.
- Additional studs are required at 'T' junctions.

Junction details

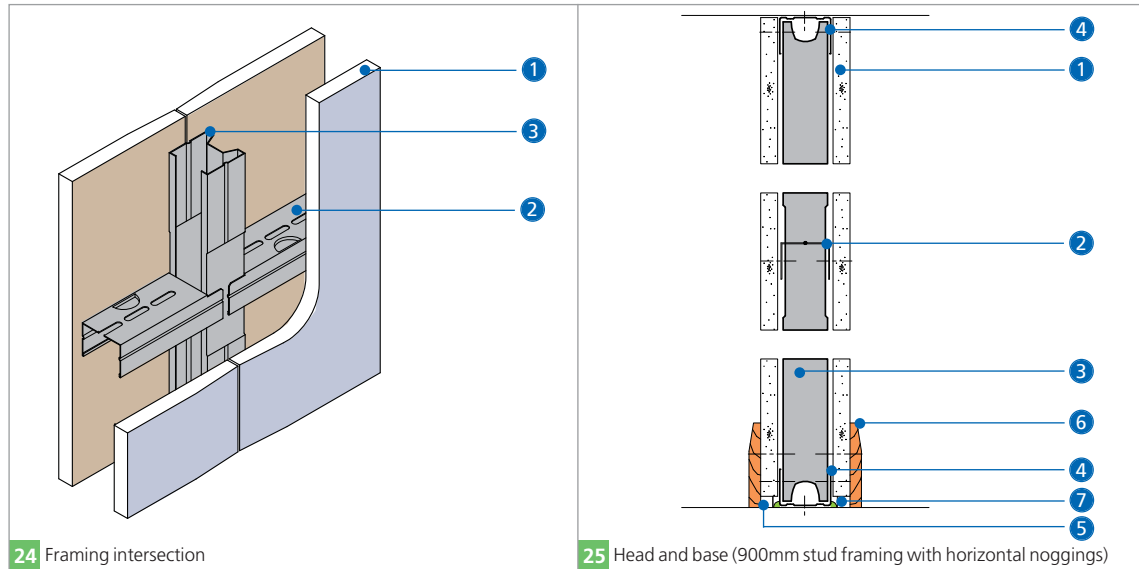

1 Gyproc SoundBloc RAPID

2 Gyproframe GWR2 Nogging Channel

3 Gyproframe 43 AS 50 AcouStud

4 Gyproframe Floor & Ceiling Channel

5 Bulk fill with Gyproc jointing materials

6 Skirting

7 Gyproc Sealant

Junction details

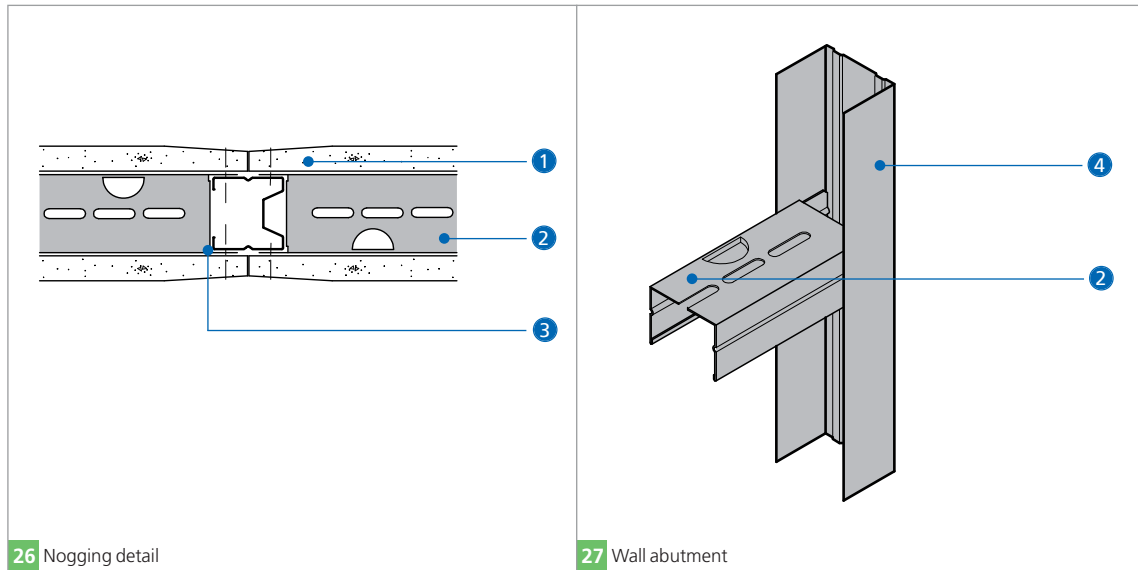

26 Nogging detail

27 Wall abutment

- 1 Gyproc SoundBloc RAPID
- 2 Gypframe GWR2 Nogging Channel
(cut end into wall channel where required)
- 3 Gypframe 43 AS 50 AcouStud
- 4 Gypframe GWR3 Floor & Ceiling Channel

Junction details

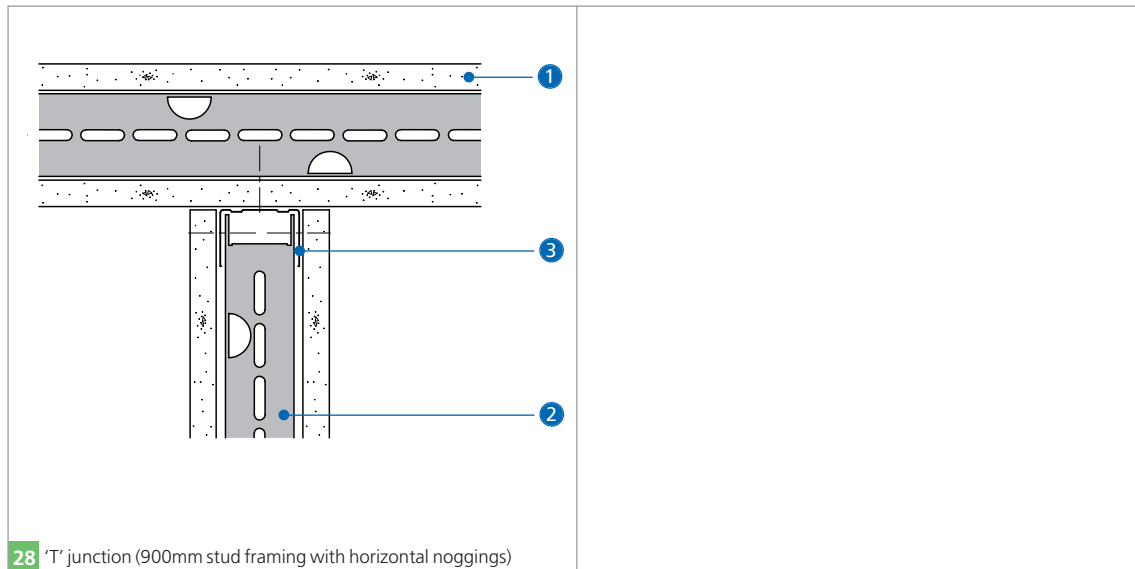

- ① Gyproc SoundBloc RAPID
- ② Gypframe GWR2 Nogging Channel
- ③ Gypframe GWR3 Floor & Ceiling Channel

Acoustic separating wall system

GypWall QUIET is a lightweight, non-loadbearing, twin-framed acoustic separating wall. Primarily used as sound resisting walls in residential units such as flats and apartments, to meet the requirements of national Building Regulations. The system can also be specified in commercial and industrial buildings to meet a specific standard of sound performance.



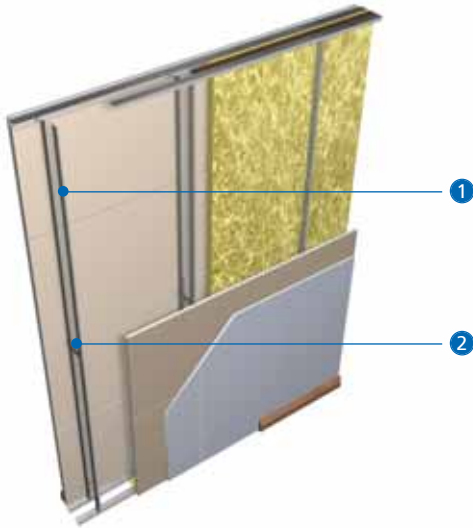



- 1 Gypframe 48 S 50 'C' Stud
- 2 Gypframe 99 FC 50 Fixing Channel cross brace

Key facts

- 200mm width option provides sound insulation capable of meeting Building Regulations Approved Document E for sound insulation between dwellings
- Satisfies excess storey height requirements
- Accommodates services between the twin-stud frameworks
- Satisfies *BS 5234* strength and robustness requirements up to Severe Duty

Components

Gyproc board products

			Take-off quantities ¹
	Gyproc Plank		
	Thickness	19mm	200m ² per layer
	Width	600mm	
	Gyproc SoundBloc²		
	Thickness	12.5, 15mm	200m ² per layer
	Width	1200mm	
	Gyproc FireLine		
	Thickness	15mm	200m ² per layer
	Width	1200mm	

Gypframe metal products











	Gypframe Standard Floor & Ceiling Channels 50 C 50	dependent on partition length
	Gypframe Deep Flange Floor & Ceiling Channels 50 DC 60	
	Gypframe Extra Deep Flange Floor & Ceiling Channels 50 EDC 70	
	All channels are available in 3600mm only	

¹ Quantities for 100m² of straight partition with a double layer of board each side. Quantities are approximate and for guidance only, no allowance has been made for waste, openings, abutments, etc.

Gypframe metal products

			Take-off quantities ¹
	Gypframe 48 S 50 'C' Stud		
	Length	2400, 2700, 3000 3300, 3600mm	335m
	Gypframe GFS1 Fixing Strap		
	Length	2400mm	as required
	Gypframe 99 FC 50 Fixing Channel		
	For cross braces		
	Length	2400mm	30m
	Gypframe 150 FC 90 Fixing Channel		
	Length	1194mm	as required
	Gypframe GA5 Internal Fixing Angle		
	Length	2400, 3600mm	as required

² Moisture resistant boards are specified in intermittent wet use areas e.g. shower cubicles.

Fixing and finishing products	Take-off quantities ¹	Fixing and finishing products	Take-off quantities ¹
 <p>Gyproc Wafer Head Drywall Screws For metal-to-metal fixing up to 0.79mm thick.</p>	as required	 <p>Gyproc Control Joint To accommodate structural movement.</p>	as required
 <p>Gyproc Drywall Screws For fixing boards to stud framing up to 0.79mm thick.</p>	1 st layer - 1400 2 nd layer - 2250	 <p>Gyproc FireStrip For fire-stopping deflection heads.</p>	as required
 <p>Gyproc Sealant For sealing airpaths for optimum sound insulation.</p>	1 cartridge per 35m based on 6-10mm bead	 <p>Thistle Multi-Finish or Thistle Board Finish To provide a plaster skim finish.</p>	10m ² per 25kg bag
 <p>Gyproc jointing materials For seamless jointing.</p>	as required	 <p>Thistle Spray Finish Gypsum finish plaster for spray or hand application.</p>	11m ² per 25kg bag
 <p>Gyproc edge beads Protecting and enhancing board edges.</p>	as required	 <p>Isover APR 1200 For enhanced acoustic performance. 25mm, 50mm.</p>	100m ²

Construction tips

- The following points should be considered in addition to the construction tips for **GypWall CLASSIC**
- The estimated construction time is 1m²- 1.5m² / man hour ready for finishing
- The stud frameworks must be cross-braced using short lengths of Gyframe 99 FC 50 Fixing Channel
- Braces should be installed at mid-height for walls up to 2400mm, or at 1200mm maximum centres where this height is exceeded

Installation

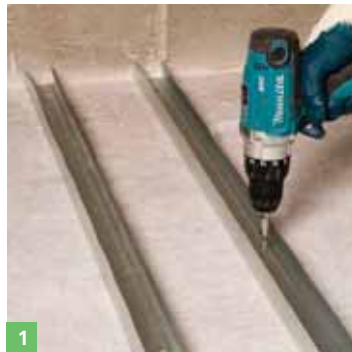

- Gyframe Floor & Ceiling Channel is fixed to the floor and soffit.
- Head and floor channels must be securely fixed with a row of fixings at 600mm maximum centres. If the floor is uneven a 38mm thick timber sole plate equal to the width of the channel should be used. If the concrete or screeded floor is new, consideration should be given to the installation of a damp proof membrane between the floor surface and the channel or sole plate.



● Gypframe 'C' Studs are fitted vertically to a friction-fit within the channel sections, and to abutments, to form the first framework. Where studs are used at heights greater than 4m, consider locking into the floor channels using a Gyproc Crimping Tool, or Gyproc Wafer Head Screws.



● The second framework is installed as the first, with stud frameworks spaced to achieve the specified wall thickness. Opposing Gypframe 'C' Studs are braced by fixing a short length of Gypframe 99 FC 50 Fixing Channel. Fix with two Gyproc Wafer Head Drywall Screws, two into each stud.

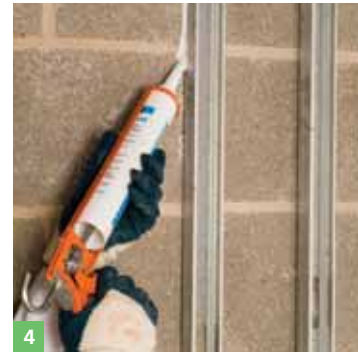

● Apply Gyproc Sealant to both sides of frame perimeter to provide optimum acoustic performance.



- Gyproframe 99 FC 50 Fixing Channel braces are installed at mid-height for walls up to 2400mm, or at 1200mm maximum centres where this height is exceeded. Fix with two Gyproc Wafer Head Drywall Screws to each side (four in total).



- Boards are screw-fixed to all framing members to form the lining. Gyproc Plank is fixed horizontally to framing members, with two Gyproc Drywall Screws per stud, and end joints are half-staggered in alternate courses. Face lining boards are fixed vertically. Joints staggered with the in-situ Gyproc Plank. Horizontal board end joints, of the outer layer, should be staggered by a nominal 300mm and be backed with Gyproframe GFS1 Fixing Strap, and fixed at 300mm centres.



- Install Isover insulation (as required) progressively as boarding proceeds.
- Isover insulation can be hung within the partition by trapping at the partition head using Gyproframe Steel Angle.



8

Services

- Install services (by appropriate trades), normally after one side is boarded. Pass horizontal runs through cut-outs in the studs.
- Install Gypframe 99 FC 50 Fixing Channel or Gypframe Floor & Ceiling Channel between studs to provide support for recessed switch boxes or use a high performance socket box detail.

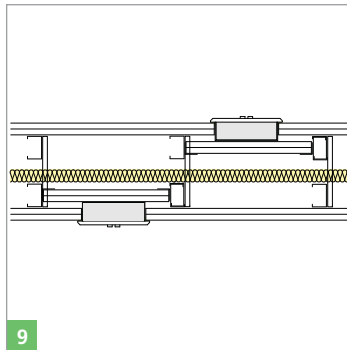

9

- Fix Gypframe GA1 Steel Angle to web of metal studs with two Gyproc Wafer Head Screws. The face layer of pattress to be equal in specification to face layer of partition boarding.

- The second layer of board forming pattress to be equal in specification to face layer of partition board or, alternatively, an equal thickness of ply if preferred. The boards are screw-fixed to the Gypframe GA1 Steel Angle with Gyproc Drywall Screws.



- Alternatively, Hilti CP617 Putty Pads can be used, contact Hilti for full details. Telephone: 0800 886100.
- All performance substantiation has to be provided by the fire-stopping manufacturer as is the case for any fire-stopping material.



Fixtures

- Additional framing is installed as required to support fixtures. For light to medium fixtures Gypframe 99 FC 50 Fixing Channel can be used. Install Gypframe 150 FC 90 Fixing Channels to accommodate heavyweight fixtures. If a plywood pattress is required, Gypframe Service Support Plates should be used.

Independent twin-frame acoustic separating wall system

GypWall QUIET IWL is a lightweight, non-loadbearing, steel 'I' stud twin-framed acoustic separating wall, that requires no bracing. As an approved Robust Detail construction (E-WS-2) it is primarily used as sound resisting walls in residential units such as flats and apartments, to exceed the requirements of national Building Regulations Part E. The system can also be specified in commercial and industrial buildings to meet a specific standard of sound performance.



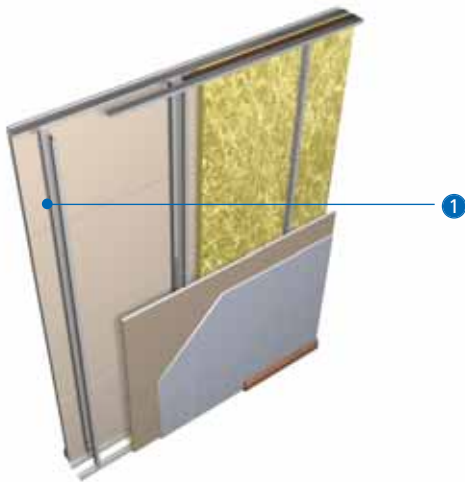



1 Gypframe 'I' Stud.

Key facts



- An approved Robust Detail (RD) construction that can be used to meet Part E regulations for separating walls without Pre-Completion Testing
- Satisfies excess storey height requirements
- Accommodates services between the twin-stud frameworks
- Satisfies *BS 5234* strength and robustness requirements up to Severe Duty

Components

Gyproc board products

			Take-off quantities ¹
	Gyproc FireLine²		200m ² per layer if specified
	Thickness	12.5, 15mm	
	Width	1200mm	
	Gyproc SoundBloc²		200m ² per layer
	Thickness	15mm	
	Width	1200mm	

Gypframe metal products

	Gypframe 60 I 70 'I' Stud		
	Length	3600, 4200mm	335m
	Gypframe 70 I 70 'I' Stud		
	Length	3600, 4200mm	335m
	Gypframe 92 I 90 'I' Stud		
	Length	5000, 6000mm	335m

¹ Quantities for 100m² of straight partition with a double layer of board each side. Quantities are approximate and for guidance only, no allowance has been made for waste, openings, abutments, etc.

Gypframe metal products

			Take-off quantities ¹
	Gypframe Standard Floor & Ceiling Channels		Dependent on partition run
		62 C 50, 72 C 50, 94 C 50	
	Gypframe Deep Flange Floor & Ceiling Channels		
		62 DC 60, 72 DC 60	
	Gypframe Extra Deep Flange Floor & Ceiling Channels		Dependent on partition run
		72 EDC 80, 94 EDC 70	
		All channels are available in 3600mm only	
	Gypframe GFS1 Fixing Strap		
	Length	2400mm	as required
	Gypframe 99 FC 50 Fixing Channel		
	Length	2400mm	as required

² Moisture resistant boards are specified in intermittent wet use areas e.g. shower cubicles

Gypframe metal products		Take-off quantities [†]	Fixing and finishing products		Take-off quantities [†]
	Gypframe 150 FC 90 Fixing Channel Length 1194mm	as required		Gyproc Jack-Point Screws For fixing boards to stud framing 0.8mm thick or greater and 'I' studs greater than 0.55mm thick.	1 st layer - 1750 2 nd layer - 2250
	Gypframe 60 S 50 'C' Stud Length 3000, 3600mm	as required		Gyproc Sealant For sealing airpaths for optimum sound insulation.	1 cartridge per 35m based on a 6 - 10mm bead
	Gypframe 70 S 50 'C' Stud Length 2400, 2700, 3000, 3600, 4200mm	as required		Gyproc jointing materials For seamless jointing.	as required
	Gypframe 92 S 50 'C' Stud Length 3600, 4200mm	as required		Gyproc edge beads Protecting and enhancing board edges.	as required
	Gypframe GA5 Internal Fixing Angle Length 2400, 3600mm	as required			

Fixing and finishing products	Take-off quantities [†]	Fixing and finishing products	Take-off quantities [†]
 <p>Gyproc Control Joint To accommodate structural movement.</p>	as required	 <p>Isover APR 1200 For enhanced acoustic performance. 100mm.</p>	100m ²
 <p>Gyproc FireStrip For fire-stopping deflection heads.</p>	as required		
 <p>Thistle Multi-Finish or Thistle Board Finish To provide a plaster skim finish.</p>	10m ² per 25kg bag		
 <p>Thistle Durafinish To provide improved resistance to accidental damage.</p>	10m ² per 25kg bag		
 <p>Thistle Spray Finish Gypsum finish plaster for spray or hand application.</p>	11m ² per 25kg bag		

[†] Quantities for 100m² of straight partition with a double layer of board each side. Quantities are approximate and for guidance only, no allowance has been made for waste, openings, abutments, etc.

Construction tips

- The following points should be considered in addition to the construction tips for **GypWall CLASSIC**
- The estimated construction time is 1 - 1.5m² / man hour ready for finishing
- For Robust Detail constructions specific flanking details apply - refer to the Robust Detail Handbook
- Robust Details Ltd Technical Support - 0870 240 8209

Installation



- Gypframe Floor & Ceiling Channel is fixed to the floor and soffit.
- 62mm or 72mm head and floor channels must be securely fixed with a line of fixings at 600mm maximum centres, 94mm with two lines of staggered fixings at 600mm maximum centres. If the floor is uneven a 38mm thick timber sole plate equal to the width of the channel should be used. If the concrete or screeded floor is new, consideration should be given to the installation of a damp-proof membrane between the floor surface and the channel or sole plate.



- Gypframe 'I' Studs are fitted vertically to a friction-fit within the channel sections, and Gypframe 'C' Studs to abutments, to form the first framework. Where studs are used at heights greater than 4m, consider locking into the floor channels using Gyproc Crimping Tool, or Gyproc Wafer Head Drywall Screws.



- The second framework is installed as the first, with stud frameworks spaced to achieve the specified wall thickness. Do not brace the two frames.



- Apply Gyproc Sealant to both sides of frame perimeter to provide optimum acoustic performance.



- Boards are screw-fixed to all framing members at 300mm centres to form the lining. Under layer boards do not require centre fixings. Cut and fix the initial second layer board as appropriate so that subsequent board joints are staggered.
- Reduce centres to 200mm at external angles.



Services

- Install services (by appropriate trades), normally after one side is boarded. Pass horizontal runs through cut-outs in the studs.
- Install Gypframe 99 FC 50 Fixing Channel or Gypframe Floor & Ceiling Channel between studs to provide support for recessed switch boxes.

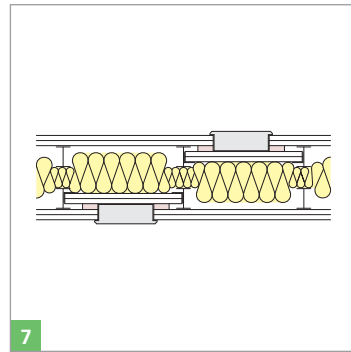

- Fix Gypframe GA4 Steel Angle to web of metal studs with two Gyproc Wafer Head Screws. The face layer of pattress to be equal in specification to face layer of partition boarding. The second layer of board forming pattress to be equal in specification to face layer of partition board or, alternatively, an equal thickness of ply if preferred. The boards are screw-fixed to the Gypframe GA4 Steel Angle with Gyproc Drywall Screws.



8

- Alternatively Hilti CP617 Putty Pads can be used, contact Hilti for full details, tel: 0800 886100
- All performance substantiation has to be provided by the fire-stopping manufacturer as is the case for any fire-stopping material.



9

Fixtures

- Additional framing is installed as required to support fixtures. For light to medium fixtures Gypframe 99 FC 50 Fixing Channel can be used. Install Gypframe 150 FC 90 Fixing Channels to accommodate heavyweight fixtures. If a plywood pattress is required, Gypframe Service Support Plates should be used.

- Install Isover insulation (as required) progressively as boarding proceeds.
- Isover insulation can be hung within the partition by trapping at the partition head using Gypframe Steel Angle.

GypWall QUIET SF

Single frame acoustic separating wall system

GypWall QUIET SF is a non-loadbearing partition which provides very high levels of sound insulation and is capable of exceeding national Building Regulations Part E separating wall standards. The partition is specified in many types of buildings, both new-build and refurbishment.



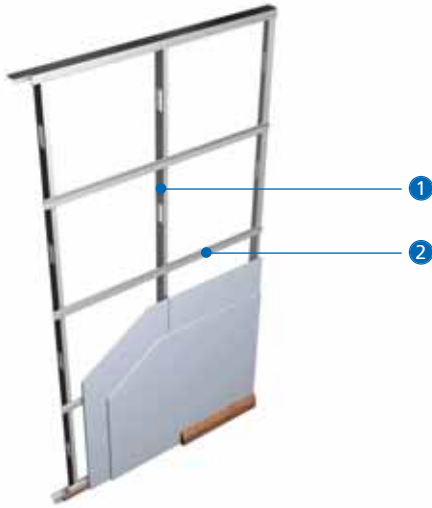

- 1 Gypframe 'C' Stud
- 2 Gypframe RB1 Resilient Bar

Key facts





- Single stud framework, maximising available floor space
- Resilient bars provide acoustic separation
- Sound insulation up to R_w 65dB to meet separating wall requirements
- Satisfies *BS 5234* strength and robustness requirements for Severe Duty
- 60 - 120 minutes fire resistance
- Accommodates services within stud cavity
- Durable, high performance Gyproc linings

Components**Gyproc board products**

			Take-off quantities¹
	Gyproc WallBoard² Thickness 12.5, 15mm Width 1200mm		200m ² per layer
	Gyproc SoundBloc² Thickness 12.5, 15mm Width 1200mm		200m ² per layer
	Gyproc Plank Thickness 19mm Width 600mm		200m ² per layer
	Gyproc DuraLine² Thickness 15mm Width 1200mm		200m ² per layer
	Gyproc FireLine² Thickness 15mm Width 1200mm		200m ² per layer

¹ Quantities are based on 100m² of straight partition with a double layer of board each side. Quantities are approximate and for guidance only, no allowance has been made for waste, openings, abutments, etc. Refer to Section 11 – Quantity take-off details.

Gypframe metal products

		Take-off quantities¹
	Gypframe 70 S 50 'C' Stud Length 2400, 2700, 3000 3600, 4200mm	167m
	Gypframe 92 S 50 'C' Stud Length 3600, 4200mm	167m
	Gypframe 146 S 50 'C' Stud Length 3000, 3600, 4200mm	167m
	Gypframe Standard Floor & Ceiling Channels 72 C 50 94 C 70 148 C 70 All channels are available in 3600mm only.	Dependent on partition length

² Moisture resistant boards are specified in intermittent wet use areas e.g. shower cubicles

Gypframe metal products (cont'd)		Take-off quantities ¹
	Gypframe 99 FC 50 Fixing Channel Length 2400mm	as required
	Gypframe 150 FC 90 Fixing Channel Length 1194mm	as required
	Gypframe RB1 Resilient Bar Length 3000mm	210m per side
	Gypframe GFS1 Fixing Strap Length 2400mm	as required

Fixing and finishing products		Take-off quantities ¹
	Gyproc Drywall Screws For fixing boards to stud framing up to 0.79mm thick.	1 st layer - 1700 2 nd layer - 2200
	Gyproc Wafer Head Drywall Screws For metal-to-metal fixing up to 0.79mm thick.	as required
	Gyproc Sealant For sealing airpaths for optimum sound insulation.	1 cartridge per 35m based on 6-10mm bead
	Gyproc jointing materials For seamless jointing.	as required
	Gyproc edge beads Protecting and enhancing board edges.	as required

Components

Fixing and finishing products



Gyproc Control Joint

To accommodate structural movement.

Take-off quantities[†]

as required



Gyproc FireStrip

For fire-stopping deflection heads.

as required



Thistle Multi-Finish or Thistle Board Finish

To provide a plaster skim finish.

or



Thistle Durafinish

To provide improved resistance to accidental damage.

or



Thistle Spray Finish

Gypsum finish plaster for spray or hand application.

10m² per
25kg bag

10m² per
25kg bag

11m² per
25kg bag

Fixing and finishing products



Isover APR 1200

For enhanced acoustic performance.
25, 50mm.

Take-off quantities[†]

100m²

[†] Quantities are based on 100m² of straight partition with a double layer of board each side. Quantities are approximate and for guidance only, no allowance has been made for waste, openings, abutments, etc. Refer to Section 11 – Quantity take-off details.

Construction tips

- The following points should be considered in addition to the construction tips for **GypWall CLASSIC**
- The estimated construction time is 1m² - 1.5m² / man hour ready for finishing
- Gypframe RB1 Resilient Bar noggings must be used at perimeters and doors to maintain screw-fixing centres
- Select correct length screws to eliminate contact with metal studs when board fixing to Gypframe RB1 Resilient Bar
- Gypframe RB1 Resilient Bar may be fixed to one or both sides, as specified

Installation



- Gypframe Floor & Ceiling Channel is fixed to the floor and soffit.

Fixing floor and ceiling channels

- Floor channels must be securely fixed with a line of fixings at 600mm maximum centres. With 94mm and 148mm channels, staggered fixings are required, each line at 600mm centres and each fixing 25mm in from the flange. If the floor is uneven a 38mm thick timber sole plate equal to the width of the channel should be used. If the concrete or screeded floor is new, consideration should be given to the installation of a damp proof membrane between the floor surface and the channel or sole plate.

- Head channels must be securely fixed at 600mm maximum centres. With 94mm and 148mm channel, staggered fixings are required, each line at 600mm centres and each fixing 25mm in from the flange.



- Gypframe 'C' Studs are fitted vertically at 600mm centres to a friction-fit within the channel sections, and to abutments, to form the framework.



- Gypframe RB1 Resilient Bars are fixed horizontally to the stud framing at 600mm centres. Bars are joined by nesting them together over a stud, with the base flange fixed to the stud. The bars are normally fixed with the base flange on the top side, with the exception of the uppermost bar which is fixed base flange down to provide board fixing at the partition head.



- Noggings of Gypframe RB1 Resilient Bars are fixed vertically to studs between horizontal bars at perimeters and doors.
- Any openings must be constructed with care so as to minimise loss of the acoustic performance. Specialist acoustic door sets may be required.



- Both layers of boards are fixed vertically to the Gyprframe RB1 Resilient Bars with joints staggered. Where Gyproc Plank is required as an inner layer fixed to the resilient bar, it is positioned vertically and fixed across its width at each bar position with two Gyproc Drywall Screws. Other boards, inner and outer, are fully fixed to all framing members at 300mm centres.
- Board joints to be staggered between Gyproc Plank and Gyproc SoundBloc by nominal 300mm.



Services

- Install services (by appropriate trades), normally after one side is boarded. Pass horizontal runs through cut-outs in the studs.
- Install Gyprframe 99 FC 50 Fixing Channel or Gyprframe Floor & Ceiling Channel between studs to provide support for recessed switch boxes, or use a high performance socket box detail.

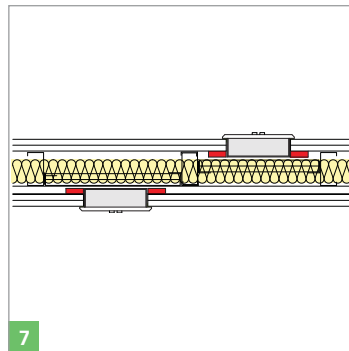

- Fix Gyprframe GA1 Steel Angle to web of metal studs with two Gyproc Wafer Head Screws. The face layer of pattress to be equal in specification to face layer of partition boarding.
- The second layer of board forming pattress to be equal in specification to face layer of partition board or, alternatively, an equal thickness of plywood if preferred. The boards are screw-fixed to the Gyprframe GA1 Steel Angle with Gyproc Drywall Screws.



- Alternatively, Hilti CP617 Putty Pads can be used, contact Hilti for full details. Telephone: 0800 886100.
- All performance substantiation has to be provided by the fire-stopping manufacturer as is the case for any fire-stopping material.



Fixtures

- Additional framing is installed as required to support fixtures. For light to medium fixtures, Gypframe 99 FC 50 Fixing Channel can be used. Install Gypframe 150 FC 90 Fixing Channels to accommodate heavyweight fixtures. If a plywood pattress is required, Gypframe Service Support Plates should be used. These are solutions for the non-Gypframe RB1 Resilient Bar side only.



- Install Isover insulation (as required) progressively as boarding proceeds.
- Isover insulation can be hung within the partition by trapping at the partition head using Gypframe Steel Angle.

GypWall STAGGERED

Staggered stud acoustic partition system

GypWall **STAGGERED** is a non-loadbearing metal stud partition which provides very high levels of sound insulation. In public and commercial developments it can be used for space division within critical areas of offices, hotels, schools, hospitals, recreational complexes, shops, and conference centres. In refurbishment work on residential units it can be used as a sound resisting, space saving partition between dwellings.



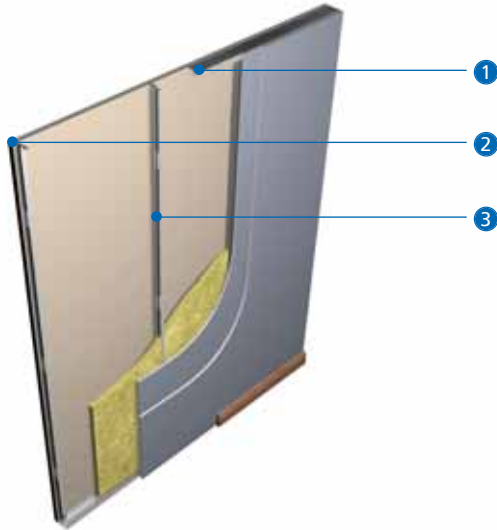



- 1 Gyframe Floor & Ceiling Channel
- 2 Gyframe Spacer Clip
- 3 Gyframe 'I' Stud



Key facts

- Choice of framing sizes to suit range of performance requirements
- Achieves very high levels of sound insulation
- Satisfies *BS 5234* strength and robustness requirements up to Severe Duty
- Up to 90 minutes fire resistance
- Single layer or double layer board linings
- Uses 'I' stud framework to give a robust partition
- De-coupled linings for high acoustic performance, with space saving partition widths

Components**Gyproc board products**

		Take-off quantities ¹
	Gyproc SoundBloc² Thickness 12.5, 15mm Width 1200mm	200m ² per layer
	Gyproc DuraLine² Thickness 15mm Width 1200mm	200m ² per layer

Gypframe metal products

	Gypframe 60 I 70 'I' Stud Length 3600, 4200mm Used with 72m Gypframe Standard Floor & Ceiling Channel to form 60/72 combination.	335m
	Gypframe 92 I 90 'I' Stud Length 3600, 5000, 6000mm Used with 148mm Gypframe Standard Floor & Ceiling Channel to form 92/148 combination.	335m





Gypframe metal products

		Take-off quantities ¹
	Gypframe 70 S 50 'C' Studs Length 2400 - 4200mm	as required
	Gypframe 146 S 50 'C' Stud Length 3000, 3600, 4200mm	as required
	Gypframe Standard Floor & Ceiling Channels 60/72 Combination Width 72mm Length 3600mm Code 72 C 50 92/148 Combination Width 148mm Length 3600mm Code 148 C 50	dependent on partition length

¹ Quantities are based on 100m² of partition with a double layer of board each side. Quantities are approximate and for guidance only, no allowance has been made for waste, openings, abutments, etc.

² Moisture resistant boards are specified in intermittent wet use areas e.g. shower cubicles.

Gypframe metal sections		Take-off quantities ¹
	Gypframe SC1 Spacer Clip (used in 60/72 combination).	2 per stud
	Gypframe SC2 Spacer Clip (used in 92/148 combination).	
	Gypframe GA5 Internal Fixing Angle Prime dimensions 60 x 60mm Angle 90°	as required
	Gypframe GFS1 Fixing Strap Length 2400mm	as required
	Gypframe 99 FC 50 Fixing Channel Length 2400mm	as required
	Gypframe 150 FC 90 Fixing Channel Length 1194mm	as required
	Gypframe GA6 Splayed Angle For splayed corners.	as required

Gypframe metal sections		Take-off quantities ¹
	Gypframe GFT1 Fixing 'T' Length 2400mm	as required
Fixing and finishing products		
	Gyproc Drywall Screws For fixing boards to stud framing up to 0.79mm thick.	as required
	Gyproc Jack-Point Screws For fixing boards to stud framing 0.8mm thick or greater and 'I' studs greater than 0.55mm thick.	1 st layer - 1750 2 nd layer - 2250
	Gyproc jointing materials For seamless jointing.	as required
	Gyproc Sealant Sealing airpaths for optimum sound insulation.	1 cartridge per 35m based on 6-10mm bead

Components

Fixing and finishing products

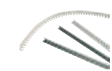

Gyproc edge beads

Protecting and enhancing board edges and corners.

Take-off quantities¹

as required



Gyproc Control Joint

To accommodate structural movement.

as required



Gyproc FireStrip

For fire-stopping deflection heads.

as required

¹ Quantities are based on 100m² of partition with a double layer of board each side. Quantities are approximate and for guidance only, no allowance has been made for waste, openings, abutments, etc.

Fixing and finishing products



Thistle Multi-Finish or Thistle Board Finish

To provide a plaster skim finish.

Take-off quantities¹

10m² per 25kg bag



Thistle Spray Finish

Gypsum finish plaster for spray or hand application.

11m² per 25kg bag



Isover APR 1200

For enhanced acoustic performance. 25mm, 50mm.

100m²

Construction tips

- The following points should be considered in addition to the construction tips for **GypWall CLASSIC**
- Estimated construction time 2m² – 2.5m² / man hour (single layer partition) or 1.5m² - 2m² / man hour (double layer partition) ready for finishing
- To maintain the high levels of sound insulation it is essential that services, fixtures, etc, do not bridge the two sets of stud linings
- Use special detailing at deflection heads (see **Junction details – deflection**) to maintain acoustic performance
- Openings require careful detailing to minimise loss of acoustic performance
- Specialist heavy acoustic doorsets may require additional support

Installation



1

- Determine and mark the wall position and make allowance for openings.
- Fix Gypframe Floor & Ceiling Channel along centre line of floor and ceiling at 600mm centres with suitable fixings.
- On uneven floors a timber sole plate, 38mm x width of channel, may be required.
- On new concrete or screeding, consider installing a damp proof membrane.

NB 148mm channels require two rows of staggered fixings (600mm centres in each row).



2

- Fix Gypframe 'C' Studs to the abutting wall at 600mm centres.

NB 146mm studs require two rows of staggered fixings (600mm centres in each row).



3

- Cut Gypframe 'I' Studs 6mm short of the floor to ceiling height using a chop saw / circular saw.

- Insert a Gypframe Spacer Clip top and bottom of the Gypframe 'I' Stud.

NB Use Gypframe SC1 Spacer Clips for engaging Gypframe 60 I 70 'I' Studs and Gypframe SC2 Spacer Clips for engaging Gypframe 92 I 90 'I' Studs.



- Use the clip as the pivot point when turning the stud to minimise sliding.



- Fit Gypframe 'I' Studs vertically within the Gypframe Floor & Ceiling Channel at 300mm centres (Gypframe 'C' Studs to abutments – see **Junction detail 11**). Alternate clips on either side of the Gypframe 'I' Stud to give the staggered stud framework.
- Fit the specified thickness of Isover APR 1200 insulation in the cavity.



- Apply Gyproc Sealant as a continuous bead to the perimeter of the framing on both sides before boarding commences, to ensure acoustic performance.



7

Board fixing

- Screw-fix boards to alternate studs (which are in contact with board) at 300mm centres using Gyproc Jack-Point Screws. Reduce centres to 200mm at external angles.
- Under-layer boards do not require centre fixings. Cut and fix the initial second layer board as appropriate, so that subsequent board joints are staggered.

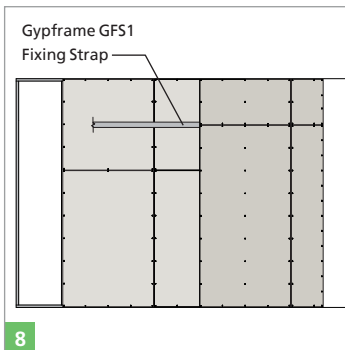

8

- Gypframe GFS1 Fixing Strap located to support horizontal joints of outer layer boards.

Installation details - plan

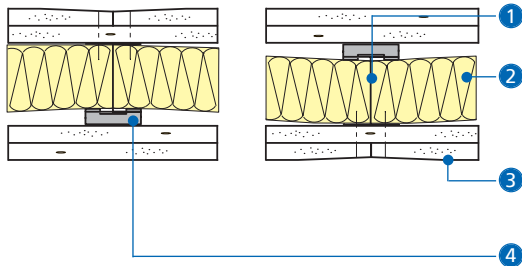

9 Plan detail (60/72 combination)

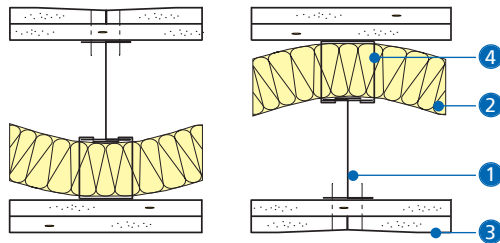

10 Plan detail (92/148 combination)

- 1 Gyprframe 'I' Stud
- 2 Isover Insulation
- 3 Gyproc SoundBloc or Gyproc DuraLine
- 4 Gyprframe Spacer Clip

Junction details - returns

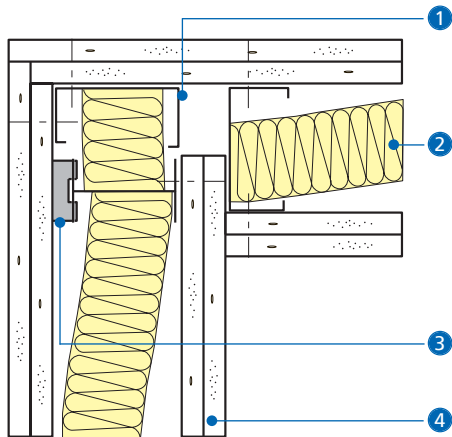

11 Corner junction

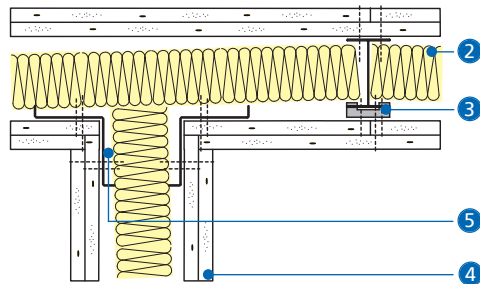

12 'T' junction

- 1 Gyprock 'C' Stud
- 2 Isover insulation
- 3 Gyprock Spacer Clip

- 4 Gyproc SoundBloc or Gyproc DuraLine
- 5 Gyprock GA5 Internal Fixing Angle

Junction details - deflection

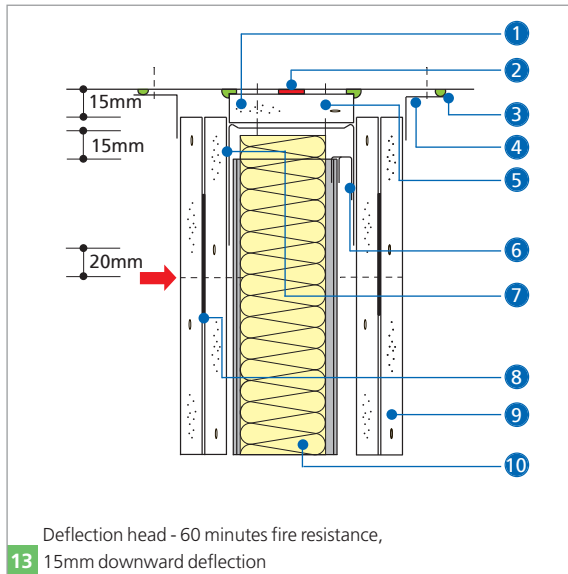

NB No fixings should be made through the boards into the flanges of the head channel. The arrow (➔) denotes the position of the uppermost board fixings which should be made into Gyproframe GFS1 Fixing Strap or studs. Continuous Gyproc FireStrip must be installed as shown in order to maintain fire performance. Gyproframe Steel Angle or approved decorative trim (by others) should be fixed to the soffit either side of the partition as shown in order to maintain the acoustic performance. Where \pm deflection is a requirement, Gyproframe SC1 or SC2 Spacer Clips must be pre-fixed to the 'I' studs to avoid the risk of disengagement once deflection is taken up.

- | | | |
|--------------------------------------|---|---------------------------------------|
| 1 Gyproc Plank | 5 Fixing through firestop into structure at 600mm maximum centres | 8 Gyproframe GFS1 Fixing Strap |
| 2 Gyproc FireStrip (continuous line) | 6 Gyproframe Spacer Clip | 9 Gyproc SoundBloc or Gyproc DuraLine |
| 3 Gyproc Sealant | 7 Gyproframe 72 EDC 80 Extra Deep Flange Floor & Ceiling Channel | 10 Isover insulation |
| 4 Gyproframe Steel Angle trim | | |

GypWall AUDIO

The ultimate sound insulating wall system

GypWall **audio** is a non-loadbearing, twin frame high performance wall system that provides exceptionally high levels of sound insulation. It is used to separate multiple use facilities such as lecture theatres, music rooms, multi-screen cinemas, conference centres, and leisure centres.

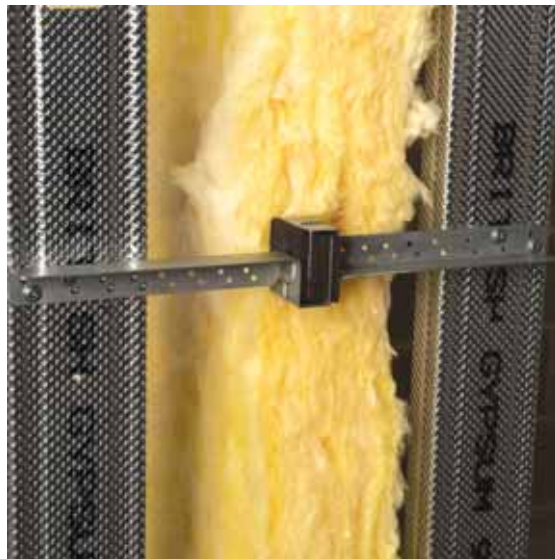

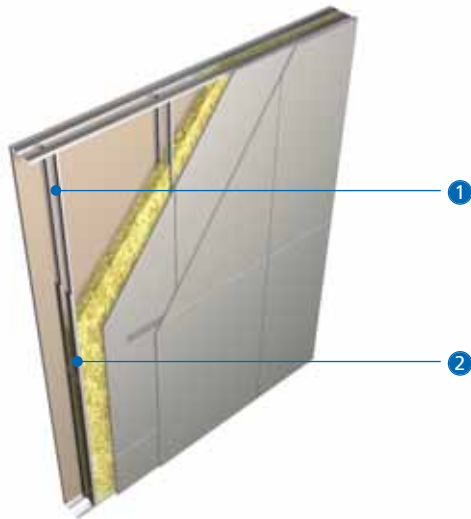



- 1 Gypframe 'C' Stud
- 2 Gypframe GAB3 Acoustic Brace or Gypframe 99 FC 50 Fixing Channel

Key facts

- Exceptionally high levels of sound insulation
- Designed to satisfy sound insulation requirements for cinemas equipped with high performance sound systems
- Lightweight, compared to masonry alternatives
- Up to 120 minutes fire resistance
- Can provide fire protection to structural steel within the wall cavity
- Gypframe GAB3 Acoustic Brace provides a resilient brace to give optimum acoustic performance





Components

Gyproc board products





			Take-off quantities ¹
	Gyproc WallBoard² Thickness 12.5, 15mm Width 1200mm		200m ² per layer
	Gyproc FireLine² Thickness 12.5, 15mm Width 1200mm		200m ² per layer
	Gyproc SoundBloc² Thickness 12.5, 15mm Width 1200mm		200m ² per layer
	Gyproc Plank Thickness 19mm Width 600mm		200m ² per layer
	Gyproc DuraLine Thickness 15mm Width 1200mm		200m ² per layer

¹ Quantities are based on 100m² of straight partition boarded with a double layer of board each side. Quantities are approximate and for guidance only, no allowance has been made for waste, openings, abutments, etc.

Gypframe metal products

			Take-off quantities ¹
	Gypframe 92 S 10 'C' Studs Length 3600, 4200mm		335m
	Gypframe Standard Floor & Ceiling Channel 94 C 70 Gypframe Deep Flange Floor & Ceiling Channels 94 DC 60 Gypframe Extra Deep Flange Floor & Ceiling Channel 94 EDC 70 All channels are available in 3600mm only	Dependent on partition perimeter	
	Gypframe 99 FC 50 Fixing Channel Length 2400mm	Where specified for bracing	
	Gypframe 150 FC 90 Fixing Channel Length 1194mm	as required	

² Moisture resistant boards are specified in intermittent wet use areas e.g. shower cubicles

Gypframe metal products		Take-off quantities ¹
	Gypframe GFS1 Fixing Strap Length 2400mm	as required
	Gypframe GA5 Internal Fixing Angle Length 3600mm	as required
	Gypframe GA6 Splayed Angle Length 2400, 3600mm	as required
	Gypframe GAB3 Acoustic Brace Length 459mm	Where specified for bracing

Fixing and finishing products		Take-off quantities ¹
	Gyproc Jack-Point Screws For fixing boards to stud framing 0.8mm thick or greater and 'I' studs greater than 0.55mm thick.	1 st layer - 1750 2 nd layer - 2250
	Gyproc Wafer Head Jack-Point Screws For metal-to-metal fixing 0.8mm thick or greater and 'I' studs greater than 0.55mm thick	as required
	Gyproc Sealant For sealing airpaths to achieve optimum sound insulation.	1 cartridge per 35m based on a 6-10mm bead
	Gyproc jointing materials For seamless jointing.	as required

Components

Fixing and finishing products



Gyproc edge beads

Protecting and enhancing board edges.

Take-off quantities¹

as required



Gyproc Control Joint

To accommodate structural movement.

as required



Gyproc FireStrip

For sealing deflection heads.

as required

¹ Quantities are based on 100m² of straight partition boarded with a double layer of board each side. Quantities are approximate and for guidance only, no allowance has been made for waste, openings, abutments, etc.

Fixing and finishing products



Thistle Multi-Finish or Thistle Board Finish

To provide a plaster skim finish.

or



Thistle Durafinish

To provide improved resistance to accidental damage.

or



Thistle Spray Finish

Gypsum finish plaster for spray or hand application.

Take-off quantities¹

10m² per
25kg bag

10m² per
25kg bag

11m² per
25kg bag



Isover General Purpose Roll

To achieve acoustic performance.

as required



Stone mineral wool

62kg/m³ slab.

as required

Construction tips

- The following points should be considered in addition to the construction tips for **GypWall classic**
- The estimated construction time is 0.5m² / man hour (nominal 6m high wall) ready for finishing
- Any openings will require careful detailing if the acoustic performance is to be maintained. Specialist heavy acoustic doorsets may require additional support. Contact British Gypsum for guidance

Installation

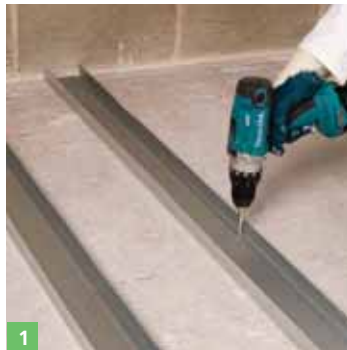

- Commence installing the first framework by fixing the Gypframe floor and ceiling channels, and studs to abutments, using suitable fixings. Insert two rows of staggered fixings at 600mm centres in each row, with the first fixing 50mm in from the channel end.
- For partition heights use the following head and floor channels: Up to 4.2m use Gypframe 94 C 70 Standard Floor & Ceiling Channels (subject to deflection head); Between 4.2m and 8m use Gypframe 94 DC 60 Deep Flange Floor & Ceiling Channels; Above 8m use Gypframe 94 EDC 70 Extra Deep Flange Floor & Ceiling Channels.



- Extend studs, if required, by splicing and locking together with a 600mm minimum nested overlap. Insert two Gyproc Wafer Head Jack-Point Screws through each flange.



- Install the second framework as the first, positioned to maintain the required overall wall thickness.



- Install Isover insulation or stone wool (as required) progressively as boarding proceeds.
- Isover insulation can be hung within the partition by trapping at the partition head using Gypframe Steel Angle.

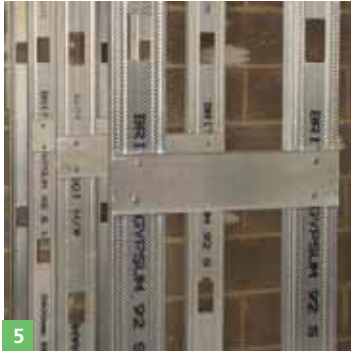

- Brace the two frameworks together by fixing short lengths of Gypframe 99 FC 50 Fixing Channel, evenly spaced at 3600mm maximum centres, inserting four Gyproc Wafer Head Jack-Point Screws to each stud position.



- Alternatively, where specified, fix Gypframe GAB3 Acoustic Brace to optimise the acoustic isolation. Install Gypframe Acoustic Braces at 3300mm maximum centres, staggered by minimum 1200mm. Insert two Gyproc Wafer Head Jack-Point Screws to each stud position.

NB The Gypframe GAB3 Acoustic Brace may be cut using a hack saw or power tool. If required, the Gypframe GAB3 Acoustic Brace can be extended by fixing a short length of Gypframe 92 S 10 'C' Stud to one brace with 4 no. Gyproc Wafer Head Jack-Point Screws, ensure a 150mm minimum overlap. The short length of stud should also be fixed to the vertical studs with 4 no. Gyproc Wafer Head Jack-Point Screws.



- Apply Gyproc Sealant as a continuous bead to the perimeter of both frameworks, before boarding commences, to provide optimum acoustic performance.

Openings

- Construct openings so as to maintain the acoustic performance.
- Where specialist heavy acoustic doorsets are specified, these will require additional support. Contact British Gypsum for suitable detailing / guidance.



Board fixing

- Screw-fix boards to framing members at 300mm centres using Gyproc Jack-Point Screws. Reduce centres to 200mm at external angles. Under layer boards do not require centre fixings.



- Where Gyproc Plank is specified, fix horizontally to framing members using two screws to each stud, including each cut end. Half-stagger end joints in alternate courses.

Shaft and duct encasement system

ShaftWall provides a lightweight, non-loadbearing fire-resistant structure to protect elements within the service cores of modern fast-track developments. It is also used to protect all forms of shafts and ducts in conventional buildings. The system provides a protective structure which can be incorporated at an early stage of the building before the building envelope is sealed. The system can also be built horizontally to provide a fire-rated membrane. **StairWall** is a derivative of the **ShaftWall** system which is used to protect stairwells.



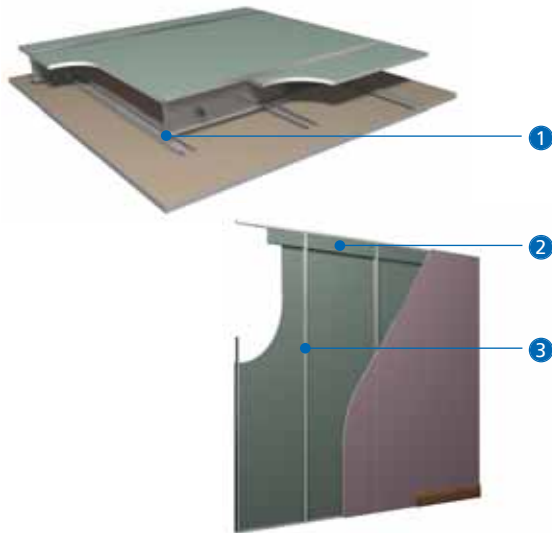

- 1 Gypframe MF5 Ceiling Section
- 2 Gypframe Floor & Ceiling Channel
- 3 Gypframe 'I' Stud, Gypframe Retaining Channel

Key facts

- Lightweight, fast-track construction
- Provides fire protective shaft enclosures, stairwells and horizontal membranes
- Shaft enclosures built from one side only
- Horizontal membranes built entirely from below
- Can be installed prior to making the building envelope weather-tight
- Minimal wall thickness from 80mm



Components**Gyproc and Glasroc board products**

			Take-off quantities ¹
	Gyproc FireLine		as required
	Thickness	12.5, 15mm	
	Width	1200mm	
	Gyproc FireLine MR		as required
	Thickness	12.5, 15mm	
	Width	1200mm	
	Gyproc CoreBoard		as required
	Thickness	19mm	
	Width	598mm	
	Gyproc DuraLine		as required
	Thickness	15mm	
	Width	1200mm	

¹ The quantities required for ShaftWall vary significantly depending on the dimensions of the installation and the performance specification of the system. Refer to section 11 - Quantity take-off details.

Gypframe metal products

		Take-off quantities ¹	
	Gypframe 'I' Studs	as required	
	Widths		60 - 70, 92 - 146mm
	Lengths		3600 - 6000mm
	Codes		60 I 70, 70 I 70 and 92 I 90, 146 TI 90
	Gypframe Starter Channel	as required	
	Widths		60 - 70, 92 - 146mm
	Lengths		3600 - 6000mm
	Codes		60 SC 55, 70 SC 70 and 92 SC 90, 146 TSC 90
	Gypframe 'J' Channel	as required	
	Width		62mm
	Length		3600mm
	Codes	62 JC 70	

Gypframe metal products		Take-off quantities ¹
	Gypframe MF5 Ceiling Section (For horizontal system only) Secondary section below 'I' Studs Length 3600mm	as required
	Gypframe Standard Floor & Ceiling Channel Widths 62, 72, 94, 148mm Lengths 3600mm Codes (head) 72 EDC 80, 94 EDC 70, 148 EDC 80 Codes (base) 62 C 50, 72 C 50, 94 C 70, 148 DC 60	as required
	Gypframe Retaining Channel G102 (for 60 and 146mm 'I' Studs) G110 (for 70mm 'I' Studs) G105 (for 92mm 'I' Studs) All channels 2400mm	as required
	Gypframe Retaining Clips G108 (for 92mm 'I' Studs) G109 (for 146mm 'I' Studs)	as required

Gypframe metal products		Take-off quantities ¹
	Gypframe GA3 Steel Angle Length 3200mm Dimensions 32 x 19 x 0.9mm	as required
	Gypframe MF6 Perimeter Channel (For horizontal system only) Perimeter support for MF5's. Length 3600mm	as required
	Gypframe 99 FC 50 Fixng Channel Length 2400mm	as required
	Gypframe GFT1 Fixing 'T' Length 2400mm	as required
	Gypframe GFS1 Fixing Strap Length 2400mm	as required

Components

Fixing and finishing products

		Take-off quantities [†]
	Gyproc Drywall Screws For fixing boards to stud framing up to 0.79mm thick.	as required
	Gyproc Jack-Point Screws For fixing boards to stud framing 0.8mm thick or greater and 'I' studs greater than 0.55mm thick.	as required
	Gypframe Wafer Head Jack-Point Screws For metal-to-metal fixing 0.8mm thick or greater and 'I' studs greater than 0.55mm thick.	as required
	Gyproc CoreBoard Dimensions 19 x 68 x 598mm and 19 x 122 x 598mm	as required
	Gyproc FireStrip For sealing deflection heads.	as required

[†] The quantities required for ShaftWall vary significantly depending on the dimensions of the insulation and the performance specification of the system. Refer to section 11 - Quantity take-off details.

Fixing and finishing products

		Take-off quantities [†]
	Gyproc Sealant Sealing air paths to achieve optimum sound insulation and sealing air shafts.	as required
	Isover APR 1200 For enhanced acoustic performance.	as required
	Gyproc jointing materials For a seamless finish.	as required
	Thistle Multi-Finish or Thistle Board Finish To provide a plaster skim finish.	10m ² per 25kg bag
	Thistle Durafinish To provide improved resistance to accidental damage.	10m ² per 25kg bag
	Thistle Spray Finish Gypsum finish plaster for spray or hand application.	11m ² per 25kg bag

Construction tips

- The following points should be considered in addition to the construction tips for **GypWall CLASSIC**
- The estimated construction time is 1.5m² - 2m² / man hour (single layer wall with deflection head) or 1m² - 1.5m² / man hour (double layer wall with deflection head) ready for finishing
- If the building envelope is left unsealed while **ShaftWall** is under construction, Gyproc FireLine **MR** should be used for the lining
- The use of pressure conditions in various types of shaft / duct requires that the boards should be sealed into the framing members using Gyproc Sealant in addition to the normal sealing of the framing to adjoining structures. It is essential that these areas are identified at a very early stage of the contract and that other trades are instructed to recognise the need for application of sealant and its replacement if subsequently damaged or removed
- If possible, plan the **ShaftWall** layout off the line of structural steelwork. This avoids special detailing such as fire protected **Z** bars
- The floor track must have continuous support from the structure

Construction tips (cont'd)

- In high usage areas the face lining of Gyproc FireLine can be substituted by Gyproc Duraline to provide a high impact resistant lining. Fire resistance will not be compromised provided that an equivalent minimum thickness of board is used
- If required for aesthetic reasons, it is permitted to fix an additional layer of 12.5mm Gyproc WallBoard to the exposed stud flanges on the shaft side to provide a smooth, seamless surface

Installation



The following procedure relates to a 60mm framework, with a 15mm deflection head. Specific references are made where the procedure for 70mm, 92mm or 146mm frameworks differs from this. The wall is installed from the room side in one direction.



- Mark the position of the wall.
- Fix floor channel at 600mm maximum centres.
- Fix head channel aligned and plumb with the floor channel at 300mm maximum centres (unless fixing to Z sections which are set at 600mm centres, when two fixings to each Z section must be used).
- Position the deep flange of the Gypframe 'J' Channel to the shaft or stairwell side.



- Apply continuous Gyproc FireStrip to the centre line of the head channel prior to fixing to maintain fire performance.
- NB** For 92mm and 146mm framing, fix head and floor channel using two rows of staggered fixings, spaced at 600mm in each row.



- Cut the Starter Channel 15mm short of the measured distance between floor and head channels in order to accommodate the designed deflection.



- Insert into position, leaving a 15mm space at the head, and fix to the vertical abutments at 600mm maximum centres.
- For 146mm Tabbed Starter Channel and stud, the tabs must be located closest to the shaft side.



- Cut Gypframe 'I' Studs and Gyproc CoreBoard 15mm short of the measured distance between floor and head channels.
- Insert Gyproc CoreBoard between the channels and push tightly into the vertical Starter Channel (use the Gypframe 'I' Stud to temporarily and loosely support the opposite edge of the Gyproc CoreBoard).



- Fix Gypframe Starter Channels to steel door frames at 300mm maximum centres.
- Carry out adjustments of alignment to the vertical with the first Gyproc CoreBoard (all studs must remain vertical throughout the fixing operation, and all cut ends of Gyproc CoreBoard must be square cut for use at the base and horizontal joints).



- Fix two 19mm x 122mm Gyproc CoreBoard fire-stops (cut on site) between the webs and behind the vertical flanges of the studs and into the head channel (see **Junction details – deflection heads**).

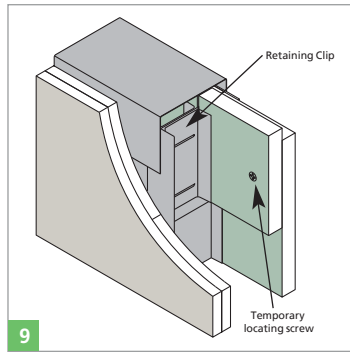

- For 92mm and 146mm frameworks two head details are available for each. The simplified detail incorporating a Gypframe Retaining Clip accommodates deflection in respect of initial building settlement. Fix as follows:
 - Friction fit a Retaining Clip into the top flanges of each Gypframe 'I' Stud so as to retain a single Gyproc CoreBoard fire-stop within the head channel. Use the Gypframe G108 component with 92mm framing and Gypframe G109 with 146mm framing.

- The alternative head detail can accommodate deflection due to live loads. This adopts a dropped soffit and uses two Gyproc CoreBoard fire-stops (cut on site) fixed horizontally to the web of the head channel. Use 19mm x 50mm with a 70mm framework, use 19mm x 68mm fire-stops with a 92mm framework and 19mm x 122mm fire-stops with a 146mm framework (see **Junction details – deflection heads**).



- Position Gypframe G102 Retaining Channel in the Starter Channel (use Gypframe G110 Retaining Channel in the case of a 70mm framework and Gypframe G105 Retaining Channel in the case of a 92mm framework).

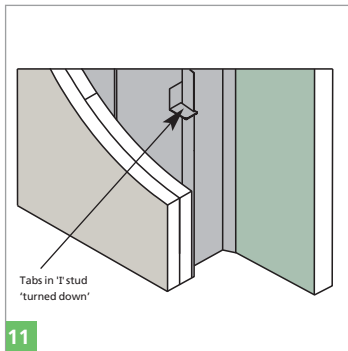

- Ensure that the Gypframe G102 Retaining Channel is securely located in the tabs when using 146mm framing.
- Push the Gypframe 'I' Stud into its permanent position to secure the first section of core boards.

- To simplify the installation of the final Gyproc CoreBoard when working between fixed points, cut boards to the required width, (minimum 300mm), less 10mm fitting tolerance. Insert the boards by twisting the flange of the last stud.

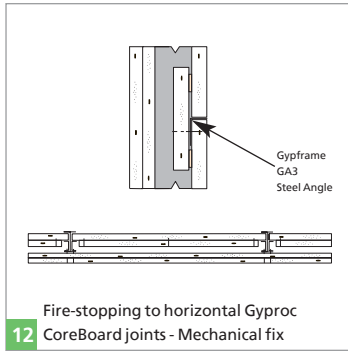

- Fire-stop horizontal joints between Gyproc CoreBoard using a 19mm x 122mm Gyproc CoreBoard fire-stop (cut on site). Fix the fire-stop to Gypframe GA3 Steel Angle using three Gyproc Jack-Point Screws, and beads of sealant top and bottom.



- NB** Before lining board fixing commences, inspect the Gyproc CoreBoard to ensure that all components including fire-stops are correctly located. Apply Gyproc Sealant in the angle formed by the perimeter framing structure.



Board fixing

- Screw-fix tapered edge Gyproc FireLine base layer boards at 300mm centres to all framing members.
- Screw-fix outer layer boards to all framing members at 300mm centres (200mm at external angles) and stagger board joints between layers.



- Where there is a horizontal joint in the lining boards, stagger end joints by 600mm minimum between layers.

- Cut lining boards 15mm short to allow for the deflection. Do not fix into the flange of the head channel (see **Junction details – deflection heads**)



- Install Gypframe GFT1 Fixing 'T' to support the end joints of single layer boards. Fix Gypframe GFS1 Fixing Strap instead in double layer boarding between board layers.
- Insert screws at 300mm centres.



Airshafts

Where **ShaftWall** is used to enclose air pressure ducts, Gyproc Sealant is used to seal potential airpaths (see **Junction details – Sealing air shafts and service ducts**).

- Apply sealant to the inside face of the rear flanges of Gypframe 'I' Studs, head channel, floor channel and Gypframe Starter Channels.



- Seal Gyproc CoreBoard fire-stops, which are located over the horizontal joints in Gyproc CoreBoard, by applying beads of Gyproc Sealant prior to fixing.
- Seal the first layer lining boards to the framework, applying Gyproc Sealant only to the face flange of the perimeter channels.

Services

- Penetrations of **ShaftWall** by services, ducts, control joints and general openings will require careful detailing. This is to ensure that the penetration does not impair the fire resistance of the wall or act as a mechanism of fire spread. Specific construction details should be determined by the designer.

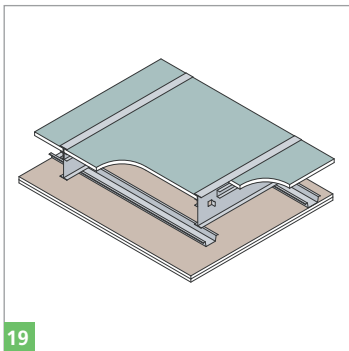

19

Horizontal ShaftWall

Horizontal **ShaftWall** is installed generally as for vertical installation with the following exceptions.

- Use 'JC' or 'EDC' Channels to receive horizontal studs.
- Fix studs into channels using Gyproc Wafer Head Jack-Point Screws, into both legs of the channel.
- Plasterboard fire-stops are not required.

- Gyproframe MF6 Perimeter Channel required at perimeter, immediately below the **ShaftWall** channels, fixed at 600mm centres.
- Gyproframe MF5 Ceiling Section fixed at maximum 450mm centres to the underside of the Gyproframe 'I' Studs with two Gyproc Wafer Head Jack-Point Screws.
- Gyproframe MF5's Ceiling Section should run at right angles to the Gyproframe 'I' Studs.

- Ceiling linings to be installed generally in line with **CasoLine MF** system (centres not exceeding 230mm in field of board and 150mm at board ends).

Junction details - general

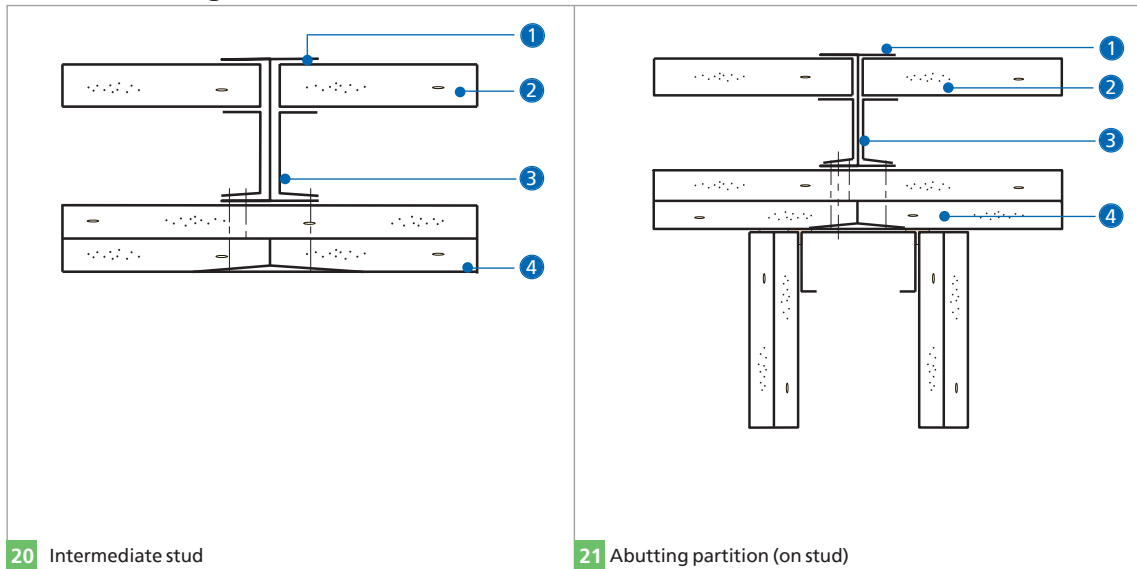

- 1 Gyproframe 'I' Stud
- 2 Gyproc CoreBoard
- 3 Gyproframe Retaining Channel

- 4 Gyproc FireLine / Gyproc DuraLine

Junction details - deflection heads

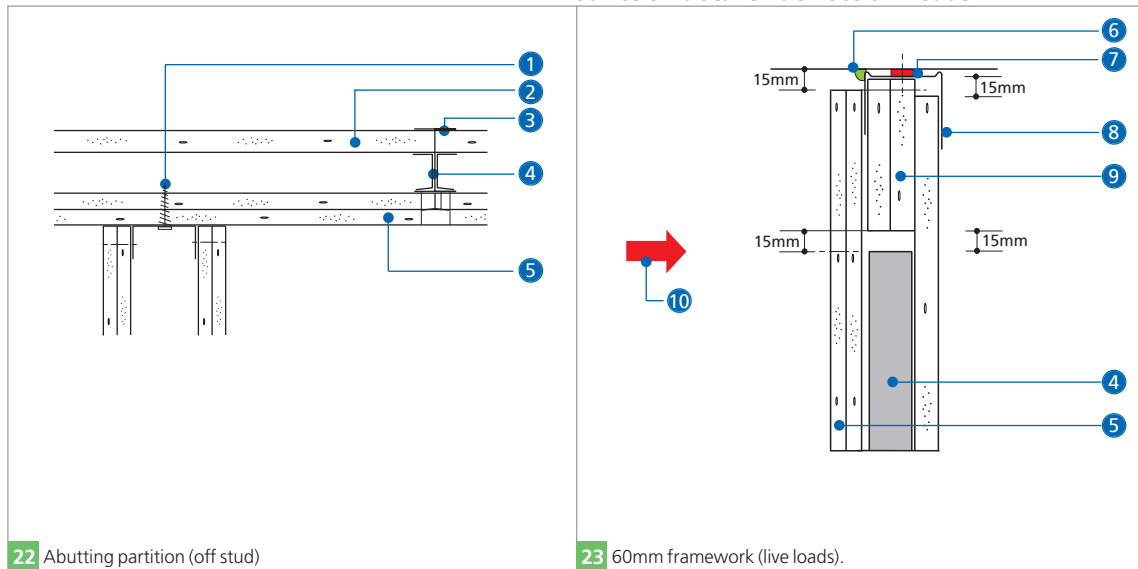

1 Metal self-drive fixing

2 Gyproc CoreBoard

3 Gypframe 'I' Stud

4 Gypframe Retaining Channel

5 Gyproc FireLine / Gyproc DuraLine linings

6 Gyproc Sealant

7 Gyproc FireStrip

8 Gypframe 'J' Channel

9 Gyproc CoreBoard fire-stop –
122mm (cut on site)

10  Upper line of board fixing into
Gypframe 'I' Stud

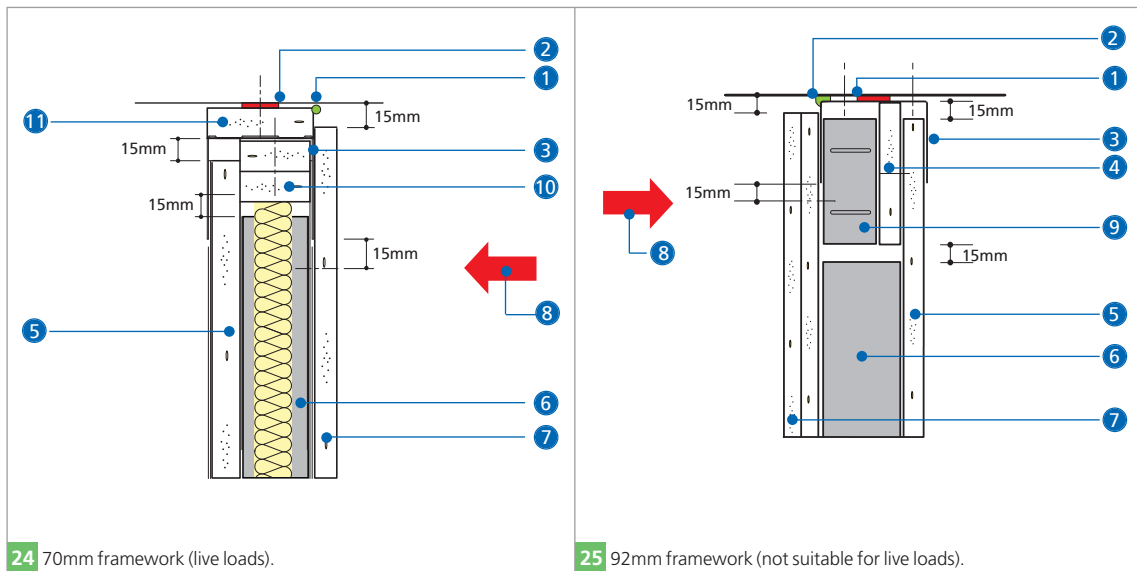

- 1 Gyproc Sealant
- 2 Gyproc Firestrip
- 3 Gypframe Extra Deep Flange Floor & Ceiling Channel
- 4 Gyproc CoreBoard fire-stop 122mm

- 5 Gyproc CoreBoard deep (cut on site)
- 6 Gypframe Retaining Channel
- 7 Gyproc FireLine / Gyproc DuraLine linings
- 8 Upper line of board fixing into

- 9 Gypframe G108 Retaining Clip
- 10 Gyproc CoreBoard fire-stop nominally 50mm wide (cut on site)
- 11 Gyproc CoreBoard as dropped soffit

Junction details - deflection heads (cont'd)

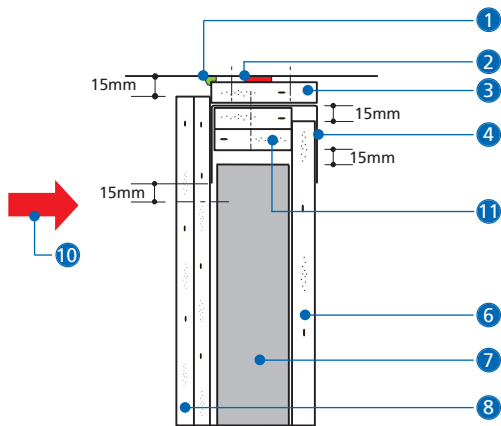

26 92mm framework (live loads).

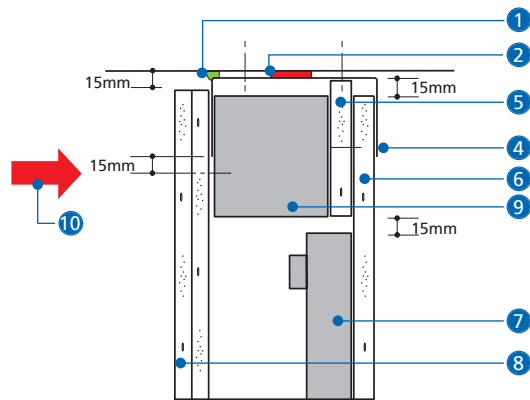

27 146mm framework (not suitable for live loads).

- 1 Gyproc Sealant
- 2 Gyproc FireStrip
- 3 Gyproc CoreBoard as dropped soffit
- 4 Gypframe Extra Deep Flange Floor & Ceiling Channel

- 5 Gyproc CoreBoard fire-stop – 122mm deep (cut on site)
- 6 Gyproc Core Board
- 7 Gypframe Retaining Channel
- 8 Gyproc FireLine / Gyproc DuraLine linings

- 9 Gypframe G109 Retaining Clip
- 10  Upper line of board fixing into Gypframe 'I' Stud
- 11 Gyproc CoreBoard fire-stops nominally 68mm wide (cut on site)

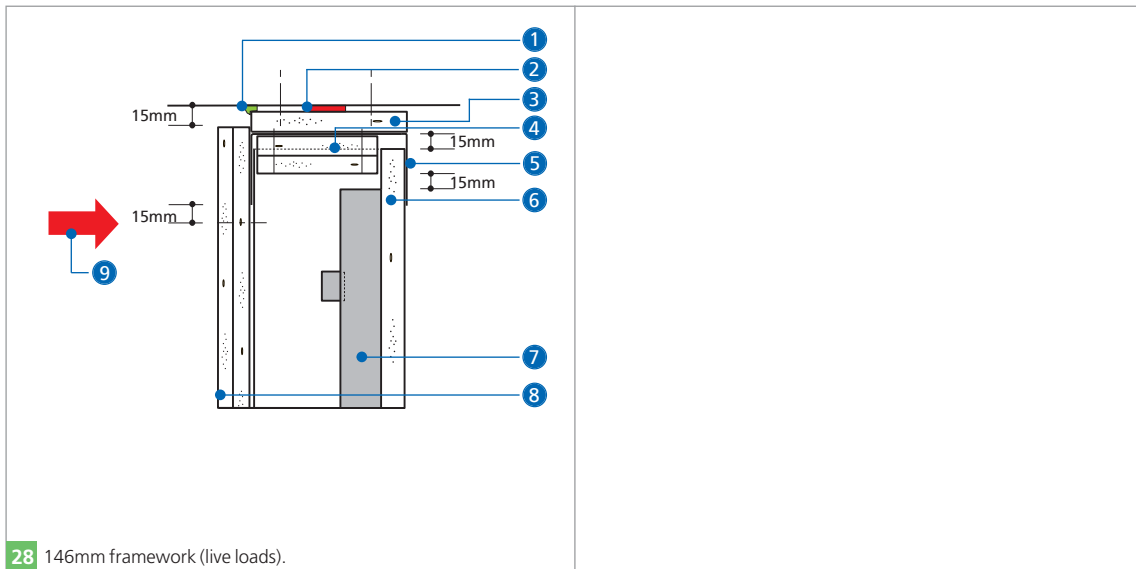

28 146mm framework (live loads).

- | | | |
|--|--|---|
| 1 Gyproc Sealant | 5 Gypframe Extra Deep Flange Floor & Ceiling Channel | 8 Gyproc FireLine / Gyproc DuraLine linings |
| 2 Gyproc FireStrip | 6 Gyproc CoreBoard | 9  Upper line of board fixing into Gypframe 'I' Stud |
| 3 Gyproc CoreBoard as dropped soffit | 7 Gypframe Retaining Channel | |
| 4 Gyproc CoreBoard fire-stop – 122mm (cut on site) | | |

Junction details - Gyproc Proflex Access Panel

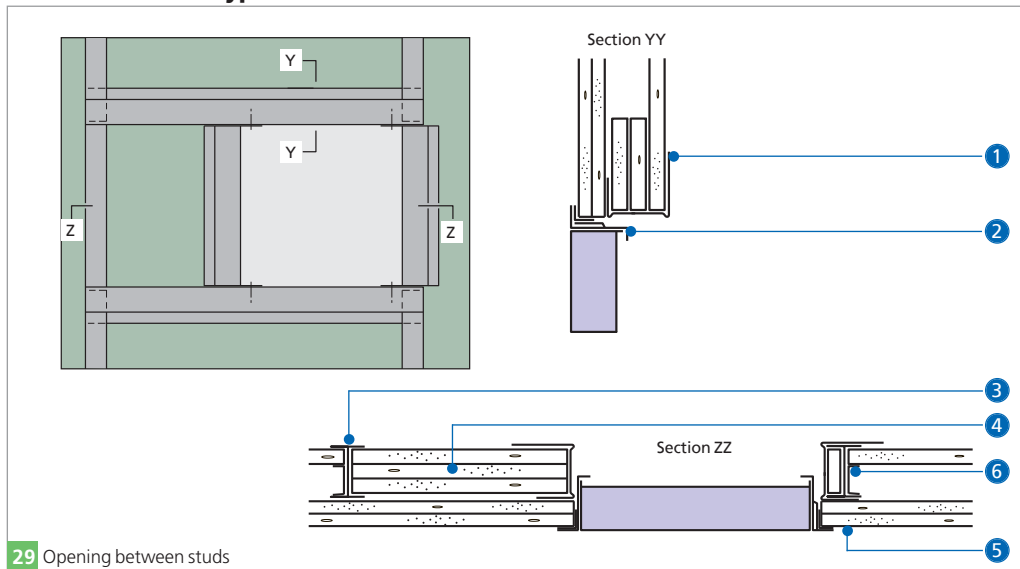

29 Opening between studs

Junction details - doors

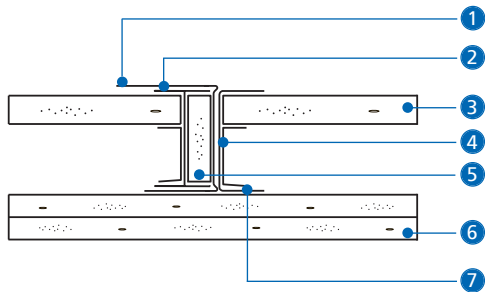

30 Access door - spandrel panel detail

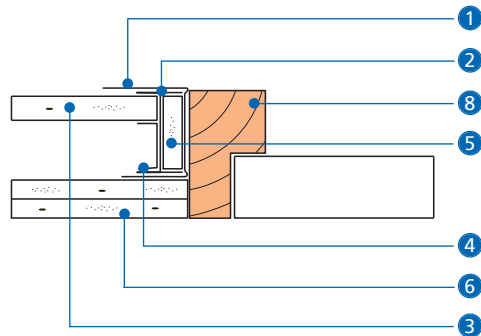

31 Access door jamb detail

- 1 Gyprframe 'J' Channel
- 2 Gyprframe 'I' Stud
- 3 Gyproc CoreBoard

- 4 Gyprframe Retaining Channel
- 5 Gyproc CoreBoard packer (cut on site)
- 6 Gyproc FireLine / Gyproc DuraLine linings

- 7 Gyprframe Starter Channel
- 8 Door frame

Junction details - sealing air shafts & service ducts

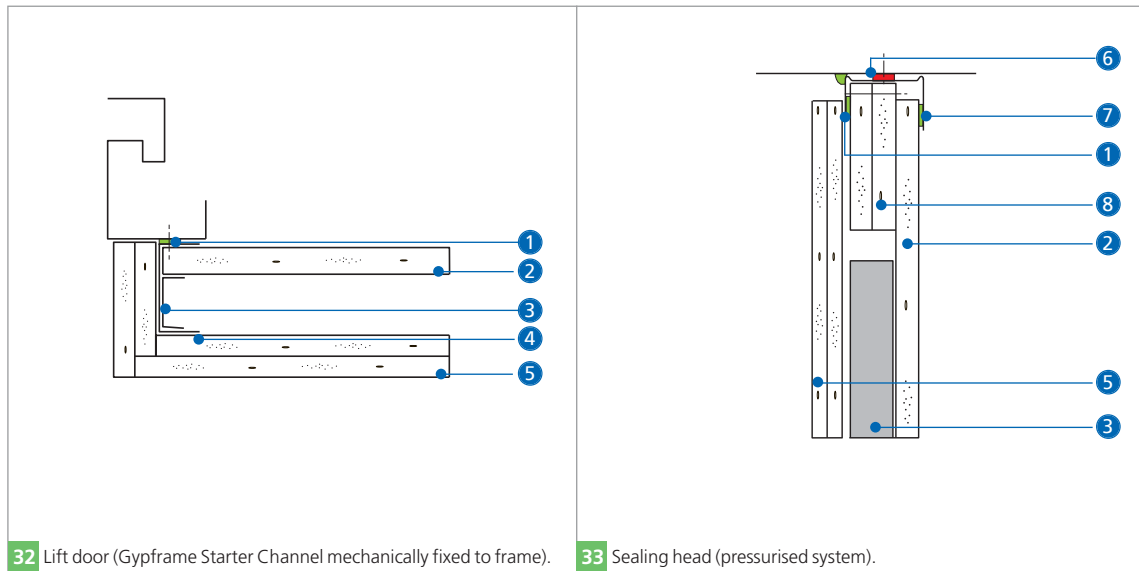

1 Gyproc Sealant

2 Gyproc CoreBoard

3 Gypframe Retaining Channel

4 Gypframe Starter Channel

5 Gyproc FireLine / Gyproc DuraLine linings

6 Gyproc FireStrip

7 Gypframe 'J' Channel

8 Gyproc CoreBoard fire-stop (cut on site)

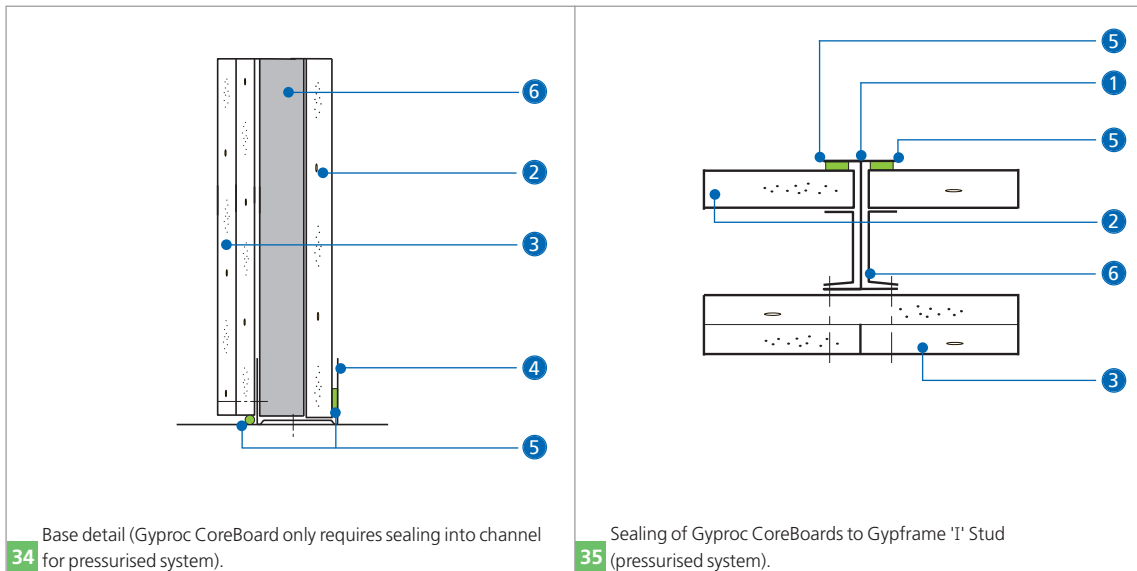

- 1** Gypframe 'I' Stud
- 2** Gyproc CoreBoard
- 3** Gyproc FireLine / Gyproc DuraLine linings
- 4** Gypframe Floor & Ceiling Channel
- 5** Gyproc Sealant
- 6** Gypframe Retaining Channel

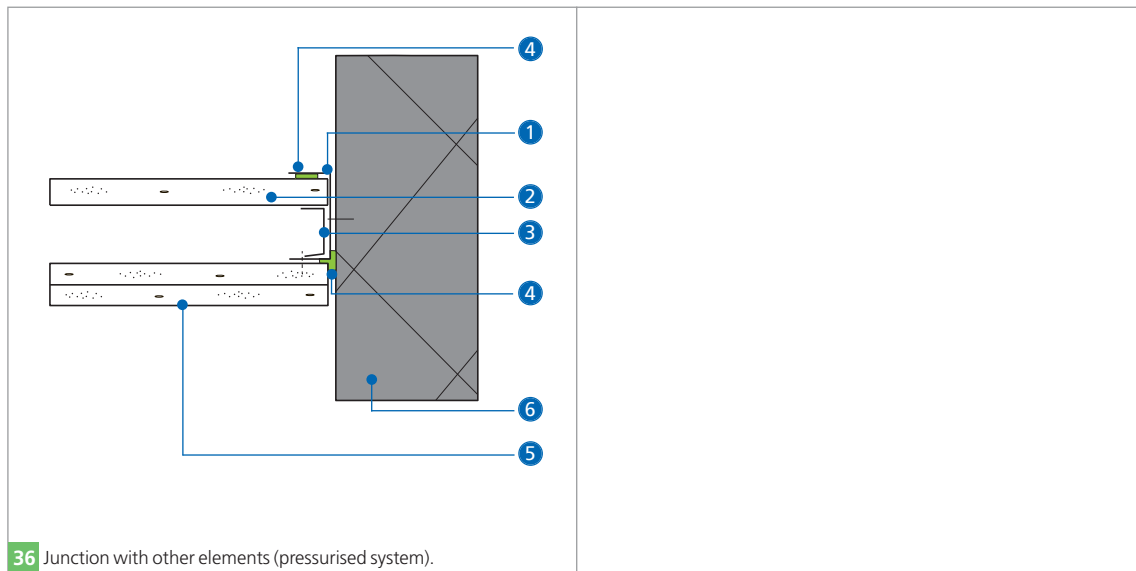

1 Gyproframe Starter Channel

2 Gyproc CoreBoard

3 Gyproframe Retaining Channel

4 Gyproc Sealant

5 Gyproc FireLine / Gyproc DuraLine linings

6 Structure

Specialist systems

A number of specialist solutions are offered which have been designed for specific end use applications. The **GypWall SECURE** and **BlastWall** systems offer high security / blast protection, offering a solution that is both lightweight and easy to install.

For further installation guidance on specialist systems, please refer to the British Gypsum website www.british-gypsum.com Alternatively, contact the British Gypsum Drywall Academy Advice Centre on Tel: 0844 800 1991.

GypWall SECURE

Attack-resistant security wall system

A robust, but lightweight, non-loadbearing security wall, offering high resistance to determined attack. It is used in commercial and industrial applications such as partition walls in banks and building societies, prisons, shops, defence establishments, industrial storage areas and data storage areas.

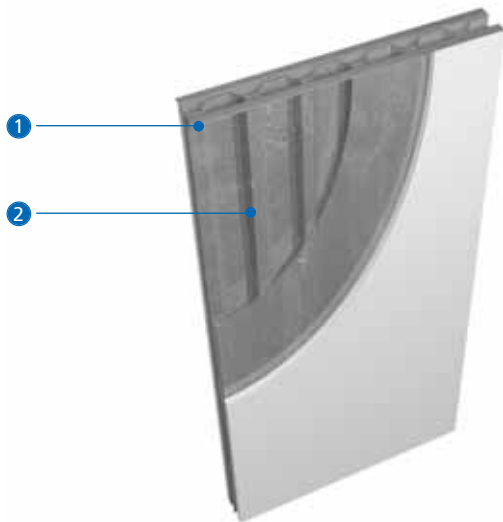

- 1 Gyframe GA4 Steel Angle
- 2 Gyframe Security Sheet

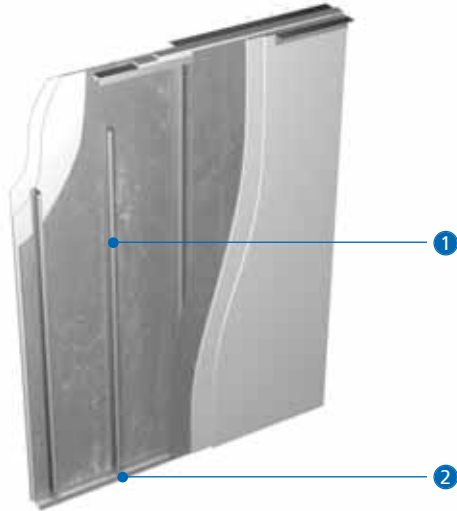

1 Gypframe 92 S 10 'C' Studs

2 Gypframe 94 EDC 70 Extra Deep Flange Floor and Ceiling Channel

BlastWall

High performance blast refuge wall system

Offers resistance to explosive devices, such as vehicle bombs, and can be specified to provide asset protection in government, commercial and industrial buildings. The system has been tested by Government departments. Variations in specification can be arrived at on an individual basis following consultation with specialist blast design consultants.

High performance fire-resistant wall system

FireWall is a non-loadbearing wall which provides up to 240 minutes fire resistance. It is used in certain ground floor basement situations in shops and industrial storage areas to provide sub-division, and other specific conditions of use as determined by insurance companies.







1 Gypframe 'C' Stud or Gypframe 'I' Stud

Key facts

- Able to satisfy insurance company requirements for enhanced fire performance
- Durable, robust linings
- Satisfies Severe Duty partition rating
- Minimal wall thickness

Components**Gyproc and Glasroc board products**

			Take-off quantities[†]
	Gyproc FireLine		
	Thickness	15mm	200m ² per layer
	Width	1200mm	
	Glasroc FireCase s		
	Thickness	15, 25mm	200m ² per layer
	Width	1200mm	
	Glasroc MultiBoard		
	Thickness	6mm	200m ² per layer
	Width	1200mm	





Gypframe metal products

	Gypframe 146 S 50 'C' Stud		
	Length	2400 - 4200mm	167m











Gypframe metal products

			Take-off quantities[†]
	Gypframe 92 S 10 'C' Stud		
	Length	3600, 4200mm	167m
	Gypframe 92 I 90 'I' Stud		
	Length	3600, 5000mm 6000mm	167m
	Gypframe Standard Floor & Ceiling Channel		
	148 C 50		Dependant on partition length
	Gypframe Extra Deep Flange Floor & Ceiling Channel		
	94 EDC 70		
	All channels are available in 3600mm only.		

[†] Quantities are for 100m² of straight partition boarded with a double layer of board each side. Quantities are approximate and for guidance only, no allowance has been made for waste, openings, abutments, etc.

Gypframe metal products		Take-off quantities ¹
	Gypframe 99 FC 50 Fixing Channel Length 2400mm	as required
	Gypframe 150 FC 90 Fixing Channel Length 1194mm	as required
	Gypframe GFS1 Fixing Strap Length 2400mm	as required
	Gypframe GFT1 Fixing 'T' Length 2400mm	as required
	Gypframe GA2 Steel Angle Used at deflection head. Length 3200mm	as required

Fixing and finishing products		Take-off quantities ¹
	Gyproc Drywall Screws For fixing boards to stud framing up to 0.79mm thick.	1 st layer - 2250 2 nd layer - 2250
	Gyproc Jack-Point Screws For fixing boards to stud framing 0.8mm thick or greater and 'I' studs greater than 0.55mm thick.	1 st layer - 2250 2 nd layer - 2250
	Gyproc Wafer Head Jack-Point Screws For metal-to-metal fixing 0.8mm thick or greater and 'I' studs greater than 0.55 thick.	as required

Fixing and finishing products	Take-off quantities ¹	Fixing and finishing products	Take-off quantities ¹
 Glasroc FireCase Screws (40mm) Fixing 6mm Glasroc MultiBoard to Glasroc FireCase s.	3 rd layer - 2250 if specified	 Gyproc FireStrip For sealing deflection heads.	If required
 Gyproc Sealant For sealing airpaths for optimum sound insulation.	1 cartridge per 35m based on a 6-10mm bead	 Thistle Multi-Finish or Thistle Board Finish To provide a plaster skim finish.	10m ² per 25kg bag
 Gyproc jointing materials For a seamless finish.	as required	 Thistle Durafinish To provide improved resistance to accidental damage.	10m ² per 25kg bag
 Gyproc Control Joint For accommodating structural movement.	as required	 Thistle Spray Finish Gypsum finish plaster for spray or hand application.	11m ² per 25kg bag
¹ Quantities are for 100m ² of straight partition boarded with a double layer of board each side. Quantities are approximate and for guidance only, no allowance has been made for waste, openings, abutments, etc.		 Isover APR 1200 For enhanced acoustic performance.	100m ² where specified
		 Stone mineral wool (100kg/m³) 40mm and 50mm thick batts (by others).	100m ² where specified

Construction tips

- Estimated construction time 1.5m² - 2m² / man hour (double layer partition) or 1m² - 1.5m² / man hour (triple layer partition) ready for finishing
- Deflection heads can be accommodated subject to special detailing

Installation



Install FireWall as per GypWall CLASSIC with the following exceptions:

- Fix floor and ceiling channels, and studs to abutments, using suitable fixings. For 94mm and 146mm channels insert two rows of staggered fixings at 600mm centres in each row, with the first fixings 50mm in from the channel end.
- Install Isover insulation or stone mineral wool (as required) progressively as boarding proceeds. To achieve 90mm total thickness of rock mineral wool (where specified), fit two batts of 40mm and 50mm thickness respectively.

Board fixing - Double layer

- Fix the first layer to studs and floor channel using Gyproc Screws at 300mm centres.
- Fix the second layer boards using Gyproc Screws at 300mm centres to studs and floor channel.
- Fix second layer board ends to horizontal Gypframe GFS1 Fixing Strap (inserted between board layers). Locate fixings at 300mm centres.

Board fixing - Triple layer

- Fix first and second layer as previous. Fix third layer 6mm Glasroc MultiBoard to the Glasroc FireCase s lining on both faces of the partition using 40mm Glasroc FireCase Screws.
- Insert screws to all edges and down the centres of the boards at 300mm centres. Stagger board joints to ensure that face layer Glasroc MultiBoard joints do not coincide with joints in the Glasroc FireCase s boards.

NB Both deflection head details incorporate a dropped soffit firestop comprising 20mm Glasroc FireCase s the same width as the channel with Gyproc FireStrip applied centrally before fixing. Stone mineral wool strips (100kg/m³) either side retained using Gypframe GA2 Steel Angle.

Timber stud

Traditional stud partitions and walls with single or twin frames

The 'traditional' form of plasterboard partition mainly used in residential applications, both in new-build and refurbishment.

Timber stud separating or compartment walls are specified as fire and sound resisting walls in residential units such as flats and apartments to meet the requirements of national Building Regulations.



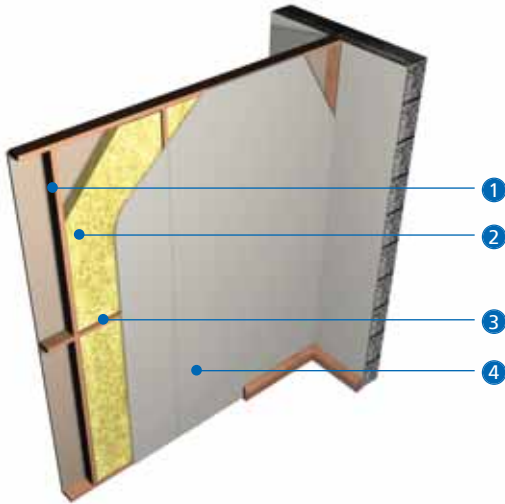





- 1 Timber studs
- 2 Isover insulation
- 3 Horizontal noggings
- 4 Gyproc plasterboard lining

Key facts

- Twin frame and Gypframe RB1 Resilient Bar constructions to meet sound resisting separating wall requirements
- Achieves high levels of fire resistance
- Achieves Part E sound resisting internal partition requirements



Components

Gyproc and Glasroc board products

		Take-off quantities ¹
	Gyproc WallBoard^{2,3} Thickness 12.5, 15mm Width 1200mm	200m ² per layer
	Gyproc SoundBloc² Thickness 12.5, 15mm Width 1200mm	200m ² per layer
	Gyproc Plank Thickness 19mm Width 600mm	200m ² per layer
	Gyproc FireLine³ Thickness 12.5 ² , 15mm Width 900, 1200mm	200m ² per layer
	Glasroc MultiBoard Thickness 6, 10, 12.5mm Width 1200mm	200m ² per layer

¹ Quantities are for 100m² of straight partition boarded with a double layer of board each side. Quantities are approximate and for guidance only, no allowance has been made for waste, openings, abutments, etc.

Framing

		Take-off quantities ¹
	Timber studs (by others) Depth 63, 75, 89mm Width as required	as required
	Gypframe RB1 Resilient Bar For improved acoustic performance. Length 3000mm	210m per side if specified
	Timber battens (by others)	as required

² Moisture resistant boards are specified in intermittent wet use areas e.g. shower cubicles.

³ Also available in DUPLEX grades where vapour control is required.

Fixing and finishing products		Take-off quantities ¹
	Gyproc Drywall Timber Screws For fixing boards to normal softwoods, super-dried timber and engineered 'I' beams.	1 st layer - 1750 2 nd layer - 2250
	Gyproc Drywall Screws For fixing boards to Gypframe RB1 Resilient Bars, and Gypframe RB1 Resilient Bars to softwood timber framing.	1 st layer - 900 per side if required 2 nd layer - 900 per side if required
	Gyproc Sealant Sealing airpaths for optimum sound insulation.	1 cartridge per 35m based on a 6-10mm bead
	Gyproc edge beads Protecting and enhancing board edges and corners.	as required

Fixing and finishing products		Take-off quantities ¹
	Thistle Multi-Finish or Thistle Board Finish To provide a plaster skim finish.	10m ² per 25kg bag
	Thistle Spray Finish Gypsum finish plaster for spray or hand application.	11m ² per 25kg bag
	Gyproc jointing materials For seamless jointing.	as required
	Isover APR 1200 For enhanced acoustic performance. 25, 50 and 100mm.	100m ² if specified
	Isover General Purpose Roll For providing acoustic / thermal insulation. 100mm.	100m ² if specified

Construction tips

- To minimise the risk of cracking at plasterboard joints, use seasoned timber with a moisture content not exceeding that recommended in *BS 5268: Part 2*. Even timber complying with the moisture content of *BS 5268* may shrink and twist as it dries, thus nail-popping may still occur
- To minimise the risk of fixing defects occurring, use Gyproc Drywall Timber Screws for fixing into standard softwood, and super-dried timber (approx. 12% moisture content). Fix boards tight to accurately spaced, aligned and levelled framing
- Select the right length of fixing (nominal entry into timber of 25mm, nominal entry into Gypframe RB1 Resilient Bar metal of 10mm)
- Ensure that the dimensions of timber supports are sufficient to allow positive fixing of plasterboards. Bearing surface of existing framing can be increased by fixing timber battens
- Install cavity barriers where specified
- Consider a damp proof membrane on new concrete or screeded floors
- Additional framing will be required to support heavyweight items (e.g. sanitary ware). Ducts and dampers will generally require independent support from the structure

Construction tips (cont'd)

- Consider fixing Gypframe RB1 Resilient Bars to partially isolate linings from timber framing to provide improved acoustic performance
- Use full height boards wherever possible
- Support single layer horizontal board joints with timber noggings
- Install control joints where specified
- Consider skirting fixing – mechanical or using Gyproc Sealant
- For further construction advice, please refer to the UK Timber Frame Association (UKTFA) web site: www.timber-frame.org

Installation

- Determine and mark the wall position and make allowance for openings.
- Fix timber of the required dimensions to the perimeter, abutments and to frame any openings, using appropriate fixings.
- Fix timber studs at appropriate centres.
- Install additional framing as required to support medium to heavy fixtures.
- Install noggings (e.g. mid-height) as required.
- Stagger noggings to allow fixing from back of studs.

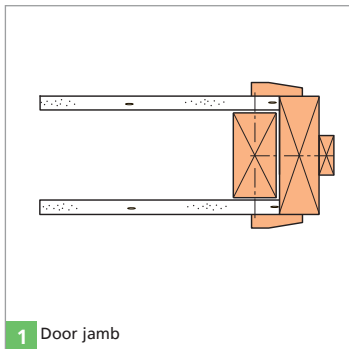

1 Door jamb

- Form door openings by fixing full height studs to each side, together with a timber head piece. Door casings can then be fixed to these timbers.
 - Apply Gyproc Sealant to frame perimeters to provide optimum acoustic performance.
 - Install services (by appropriate trades), normally after one side is boarded.
- NB** Drills / hole saws are required to form service holes in timber studs.

- Fix timber noggings to support recessed switch boxes / socket outlets. Back service outlets with 30mm stone mineral wool (80 kg/m³) to maintain fire integrity, where required. Alternatively Hilti CP617 Putty Pads can be used, contact Hilti for full details, tel: 0800 886100.
- All performance substantiation has to be provided by the fire-stopping manufacturer as is the case for any fire-stopping material.



2

Board fixing - single layer

- Fix boards to timber supports using Gyproc Drywall Timber Screws. The former provide a superior fixing and minimises any risk of fixing defects occurring.
 - Where screws are used, install at 300mm maximum centres (200mm maximum centres at external angles).
- Select the appropriate length of fixing to provide a nominal 25mm penetration into the timber.

- Drive fixings straight and firmly home (not skewed) to leave a shallow depression to facilitate spotting with Gyproc jointing materials.

NB Select the appropriate length of fixing to provide a nominal 25mm penetration into the timber. Refer to **Table 1 – Gyproc plasterboard or Glasroc specialist board fixed to timber supports** in this section, and **Table 2 – Fixing to timber sections** in General site guidance – Board fixing.

- Lightly butt boards, inserting fixings not closer than 10mm from bound edges and 13mm from cut edges.

- Where door openings occur, cut boards around the openings to avoid a joint directly in line with door jambs.

- Stagger board joints relative to the opposite side.

Double layer linings

- Mark the position of studs prior to installing first layer boards.

- After first layer boards have been installed, transfer these dimensions to the lining and mark lines to indicate the position of timber supports. Under layer boards do not require centre fixings.

- Install second layer boards with edges/ends against the centre line of supports with all joints staggered in relation to the first layer. Fix boards to all supports using Gyproc Drywall Timber Screws (preferred).

- Where Gyproc Plank is specified as the base layer, install horizontally and fix to each stud position. Half stagger end joints in alternate courses.

Acoustic detailing

- Install Isover insulation progressively as boarding proceeds.

NB Seal any gaps at the base of linings with Gyproc Sealant (in conjunction with Gyproc Joint Filler) where the partition is required to meet its optimum acoustic performance (see **Junction detail 5**).

Twin frameworks

- Where a twin framework is specified, install the second framework as the first and position so as to achieve the required overall wall thickness.

Installation - Gypframe RB1 Resilient Bar fixing



- If supports are at closer centres trim the board as appropriate.
- Noggings are required to support horizontal joints. Provide support for board ends and edges at the perimeter. Stagger horizontal joints and tape all joints when the board is plastered.
- Fixing - follow the instructions in 'Board fixing - single layer' or double layer as appropriate.

Installation - Gypframe RB1 Resilient Bar fixing

- Where Gypframe RB1 Resilient Bars are required, these are fixed horizontally to the timber studs to one or both sides as specified, at 600mm centres with 36mm Gyproc Drywall Screws.

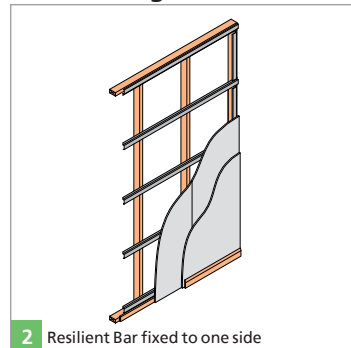

2 Resilient Bar fixed to one side

- The bars are normally fixed with the base flange on the top side, with the exception of the uppermost bar which is fixed base flange down to provide board fixing at the partition head.
- Timber packers (16mm thick) should be used at the base to facilitate skirting fixing.

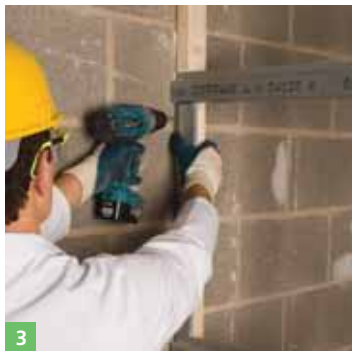

- Install Gyproframe RB1 Resilient Bar noggings where required to support the lining at corners, openings and abutments.



- Install boards vertically, fixing at 300mm centres along each Gyproframe RB1 Resilient Bar using Gyproc Drywall Screws. Select the fixing to give a minimum 10mm penetration into the metal.

- Lightly butt boards, inserting fixings not closer than 10mm from bound edges and 13mm from cut edges. Stagger board joints relative to the opposite side.

- At abutments and openings, insert screw fixings into Gyproframe RB1 Resilient Bar noggings at 300mm centres. At external corners, fixing centres are reduced to 200mm centres.

- For double layer linings mark the position of bars prior to installing first layer board. After first layer boards have been installed, transfer these dimensions to the lining and mark lines to indicate the position of bars.

- Fix second layer board to Gyproframe RB1 Resilient Bar as for first layer. Stagger board joints.

NB Ensure that board fixings into Gyproframe RB1 Resilient Bar clear the timber stud position otherwise acoustic isolation will be impaired.

Table 1 - Gyproc plasterboard or Glasroc specialist board fixed to timber supports

Board type	Thickness mm	Width mm	Recommended stud centres mm
Gyproc WallBoard	12.5	900	450
		1200	600
	15	900	450
		1200	600
Gyproc FireLine	12.5	900	450
		1200	600
	15	900	450
		1200	600
Gyproc Plank	19	600	600
Gyproc SoundBloc	12.5	1200	600
	15	1200	600
Glasroc MultiBoard	10	1200	600
	12.5	1200	600

Junction details

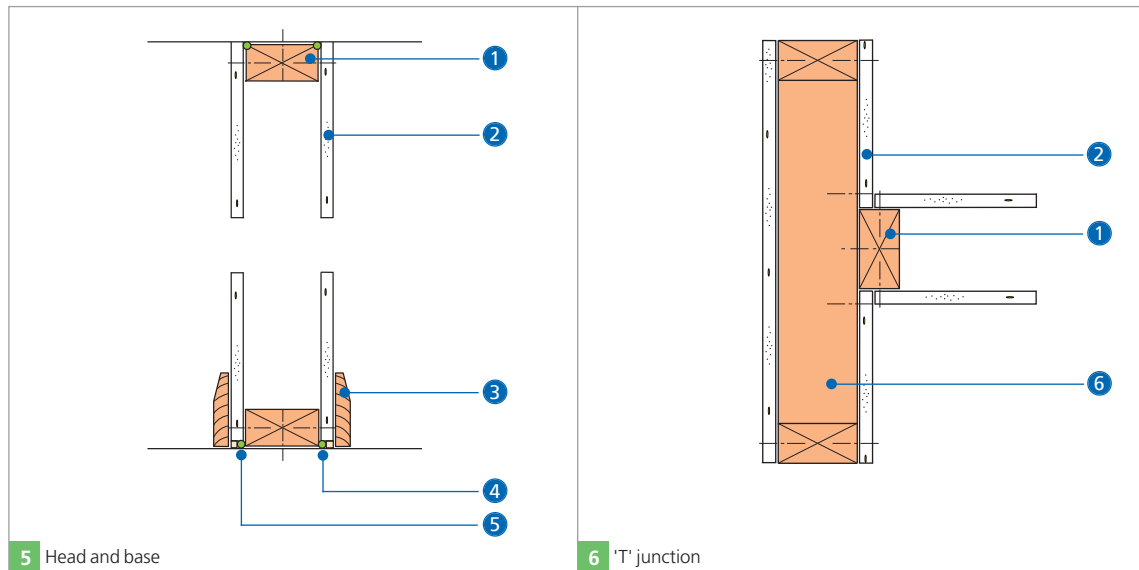

5 Head and base

6 'T' junction

- 1 Timber framing
- 2 Gyproc plasterboard
- 3 Skirting

- 4 Gyproc Sealant
- 5 Bulk filled with Gyproc jointing materials
- 6 Timber ladder frame (ladder members at 600mm max centres)

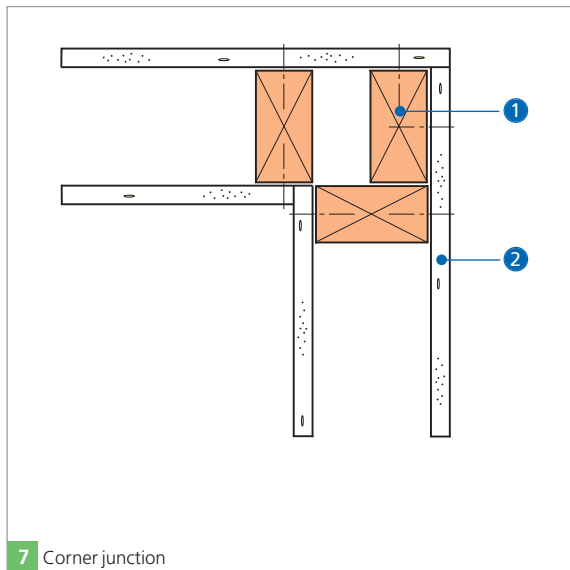

7 Corner junction

- 1 Timber framing
- 2 Gyproc plasterboard

Drywall masonry lining systems

The **DriLyner** systems are simple, effective techniques for direct bonding of boards to solid backgrounds. The variants are:

DriLyner BASIC: bonding Gyproc WallBoard, Gyproc Moisture Resistant or Gyproc DuraLine using Gyproc Dri-Wall Adhesive.

DriLyner TL: bonding Gyproc ThermaLine laminates using Gyproc Dri-Wall Adhesive, for thermal upgrading.

DriLyner st: bonding Gyproc TriLine using Gyproc Dri-Wall Adhesive, for acoustic upgrading.

DriLyner RF: bonding Gyproc plasterboards to flat walls in refurbishment situations, using blobs of Gyproc Sealant.

DriLyner MF: fixing Gyproc plasterboards (including **DUPLEX** grades) or Gyproc ThermaLine laminates to Gypframe MF10 Channels which are bonded to the wall using Gyproc Dri-Wall Adhesive.



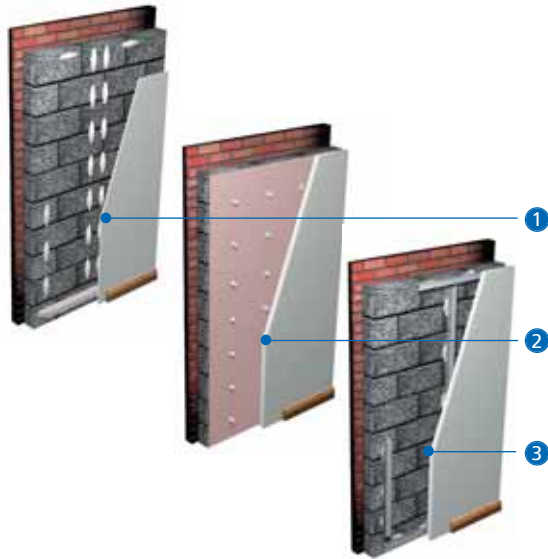

- 1 DriLyner **BASIC** system, DriLyner **TL** and DriLyner **SI** systems
- 2 DriLyner **RF** system
- 3 DriLyner **MF** system

Key facts



- Gyproc Soundcoat Plus allows compliance with Robust Details
- Achieves excellent U-values
- Gyproc TriLine is used to upgrade sound insulation
- Comfortable room temperatures are quickly achieved
- Services incorporated with minimum chasing

Components**Gyproc board products**

			Take-off quantities ¹
	Gyproc WallBoard²		100m ²
	Thickness	9.5, 12.5mm	
	Width	900, 1200mm	
	Gyproc WallBoard TEN		100m ²
	Thickness	12.5mm	
	Width	1200mm	
	Gyproc WallBoard DUPLEX		100m ²
	Thickness	9.5, 12.5mm	
	Width	1200mm	
	Gyproc DuraLine²		100m ²
	Thickness	15mm	
	Width	1200mm	

¹ Quantities are for 100m² of straight wall lining. Quantities are approximate and for guidance only, no allowance has been made for waste, openings, abutments, etc. Refer to **section 11 - Quantity take-off details**.

Gyproc board products



			Take-off quantities ¹
	Gyproc TriLine		100m ²
	Thickness	52mm	
	Width	900mm	
	Gyproc ThermaLine laminates range		100m ²
	Thickness	22 - 93mm	
	Width	1200mm	

Specialist board products



	Glasroc H TILEBACKER³		100m ²
	For use with the DriLyner BASIC and DriLyner MF systems.		
	Thickness	12.5mm	
	Width	1200mm	

² Moisture resistant boards are specified for intermittent wet use areas, or Glasroc H TILEBACKER where appropriate.





³ For tiling guidance, refer to **section 10 - Tiling**.

Gypframe metal products		Take-off quantities ⁷
	Gypframe MF10 Channel Length 2800mm	250m
	Gypframe G106 Skirting Plate To provide a fixing for skirtings over Gyproc TriLine.	2 per board if specified

Fixing and finishing products

	Gyproc Soundcoat Plus Gypsum based parge coat for sealing masonry party walls prior to drylining.	20 bags
	Gyproc Dri-Wall Adhesive For dab fixing in the DriLyner BASIC, TL, SI and MF systems. 25kg bags.	16 bags (BASIC, TL, MF systems) 18 bags (SI system)
	Gyproc Nailable Plugs Diameter 6mm Length 60, 80, 100, 110, 120, 135mm	2 per laminate

Fixing and finishing products

		Take-off quantities ⁷
	Gyproc Sealant Used as an adhesive in DriLyner RF and DriLyner MF when fixing thermal laminates, and for sealing small air gaps and option for fixing skirting boards.	DriLyner MF/ Thermal Laminates - 12 litres DriLyner RF/ Thermal Laminates - 16 litres DriLyner RF/ Gyproc TriLine - 32 litres
	Thistle Multi-Finish or Thistle Board Finish To provide a plaster skim finish.	10m ² per 25kg bag
	Thistle Spray Finish Gypsum finish plaster for spray or hand application.	11m ² per 25kg bag
	Gyproc jointing materials For a seamless finish.	as required

Construction tips

- Estimated construction times ready for finishing, are as follows:
- **DriLyner BASIC** 7m², **DriLyner TL** 6m², **DriLyner MF** 5m², **DriLyner RF** 11m², **DriLyner SI** 5m² per man hour
- To determine lining dimensions at reveals & soffits, allow for minimum cavity thickness plus the board thickness (10mm for **DriLyner BASIC, TL & SI**, 20mm for **MF**, 3mm for **RF** from the high point of the background)
- Install ceilings before **DriLyner** linings, ensuring the boards are cut close to the wall. Normally partitions which abut the inner leaf of the external wall should also be installed before the wall lining to achieve optimum acoustic performance
- Backgrounds should be reasonably dry and protected from the weather. Brush down backgrounds to remove dust. Cast concrete must be free of shutter release agents and dampened before applying adhesive dabs. Some concrete will need pre-treatment with ThistleBond-it applied in bands corresponding to adhesive dab locations (e.g. if exceptionally dense or smooth, or made with limestone, brick or granite aggregates)
- Backgrounds for **DriLyner RF** must be sound and flat, e.g. existing plastered walls or level brick, block or fair-faced concrete
- Allow for variations in background suction - allow excessively wet backgrounds to dry, and in hot/dry conditions take care to avoid rapid loss of moisture prior to the set of the adhesive

Construction tips (cont'd)

- Ensure walls are thoroughly dry before installing a vapour control layer
- Close the drylining cavity to maintain thermal performance, by ensuring abutting elements are well fitted and junctions sealed. Where perimeter sealing is to be done by the drylining contractor, apply a continuous fillet of Gyproc Dri-Wall Adhesive or Gyproc Sealant to the wall perimeter and around any service penetrations or openings
- Allow for skirting fixing by providing a continuous band of adhesive for mechanical fixing, using Gypframe Skirting Plates or fixing with Gyproc Sealant as appropriate
- Seal small gaps with Gyproc Sealant to avoid loss of acoustic performance
- Form vertical cavity barriers in long runs of lining, using a continuous line of dabs where specified
- Allow the lining to bridge structural columns – do not locate dabs on the column
- Ensure dabs cover minimum 20% of the board area. This is particularly important with heavier board linings
- Where specified, use secondary mechanical fixings, which delay board fall in the event of a fire
- Use **GypLyner UNIVERSAL** if cavity thickness over 25mm is required
- When tiling, refer to **section 10 - Tiling** for further guidance

Installation

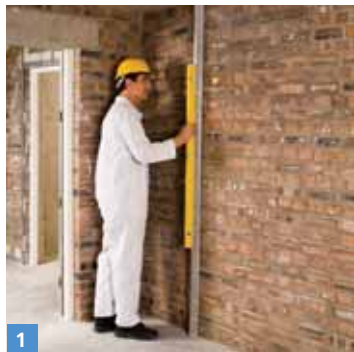

1

DriLyner BASIC system

Installing 12.5mm, 1200mm width Gyproc plasterboards.

NB If Gyproc Soundcoat Plus is specified, apply a continuous coat of at least 6mm to the entire surface. Do not trowel smooth. Allow 120 minutes minimum setting time before Gyproc Dri-Wall Adhesive dabs are applied.

- Determine high spots on the wall and plumb position to the ceiling and floor.



2

- Transfer this dimension to the room corners, add an allowance of 10mm plus the board thickness and strike continuous chalk lines on the floor and ceiling.



3

- Mark wall with lines at 1200mm centres to indicate board positioning.



- Trowel apply a continuous fillet of Gyproc Dri-Wall Adhesive to the perimeter of the wall, services and openings for optimum airtightness.
- Commence drylining from a window / door reveal or internal angle.
- Trowel apply adhesive to form dabs 50mm to 75mm wide and about 250mm long.



- Position dabs of Gyproc Dri-Wall Adhesive in three vertical rows to receive the first board.
- Ensure that the dabs adjacent to a board joint are approximately 25mm in from the edge to avoid bridging the joint.
- Apply intermediate dabs at ceiling level.



- Apply a continuous band of Gyproc Dri-Wall Adhesive at skirting level.



- Cut plasterboard 15mm short of the floor to ceiling height.
- Position the first board, reverse side against the dabs, with the bottom edge resting on plasterboard packing strips.



- Tap the board back firmly using a straight-edge until it aligns with the ceiling and floor chalk lines.



- Gently lift using a footlifter until the board is tight against the ceiling.
- Insert additional packing strips at the base to wedge the board in place and remove the footlifter.
- Apply dabs for the next plasterboard and continue the drylining with boards lightly butted.
- At internal angles cut board to fit and position the cut edge to the angle.

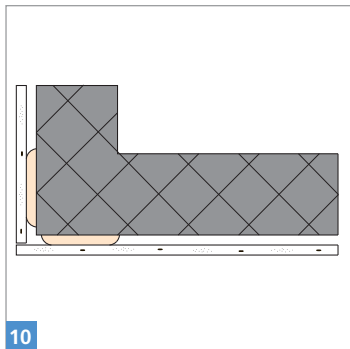

- At external angles apply rows of Gyproc Dri-Wall Adhesive dabs close to the angle on each side. Position the cut board edge to the inside.

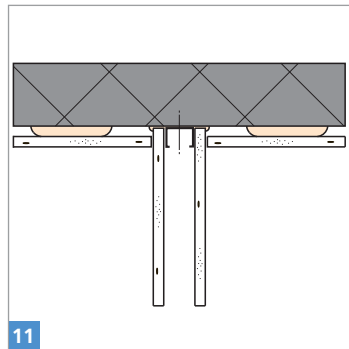

- At partition abutments apply rows of Gyproc Dri-Wall Adhesive dabs close to each side and cut lining boards to a neat fit.

- At windows apply a continuous band of dabs just above the head as a ground for fixing curtain track. Consider additional dabs at the position of cupboards, radiators, etc.

NB When applying dabs ensure that they are in a regular pattern and that the contact area between board and background is at least 20%.

Services

- The cavity between the linings and the background can be used to incorporate services. This minimises the depth of chasing required in the background.
- Fix pipes and conduits in position before commencing lining work.
- Maintain an airtight construction by sealing the perimeter of any penetration as required at the time of installing the services.

- Gas pipes should be installed in accordance with *BS 6891 Domestic Natural Gas Safety* which requires pipes to be fully enclosed e.g. using Gyproc Dri-Wall Adhesive.

Fixtures

For medium and heavy fixtures, select fixing devices of sufficient length to penetrate well into the masonry wall.

Installing 9.5mm x 1200mm Gyproc WallBoards

Install as for 12.5mm thick boards but apply dabs of Gyproc Dri-Wall Adhesive in four vertical rows per board.

Installing 900mm width Gyproc WallBoards

Install as for 1200mm width boards but mark the wall at 900mm centres to indicate board positioning.

Installing MR grade or Gyproc DuraLine boards

Install as for Gyproc WallBoard of equivalent size. When installing MR grade no pre-treatment is required to the back of the board.

Installing Glasroc H TILEBACKER

When tiling, refer to **section 10 - Tiling** for further guidance.

Installation

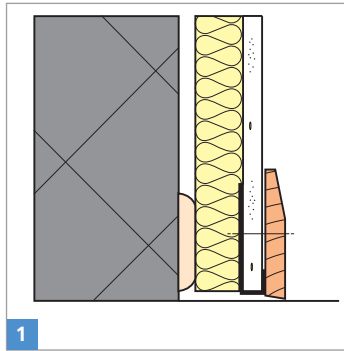

DriLyner TL system

Installing Gyproc ThermaLine laminates

Proceed as for DriLyner BASIC system with the following exceptions:

- Locate Gypframe Skirting Plates (optional) over the bottom board edge with rear of plate inserted between the plasterboard and insulating backing.



- Position at 600mm centres, 300mm in from each long edge.



● At reveals and external angles run the lining past the corner and cut back the insulating backing so as to form a neat junction with the reveal board or wall lining.

NB The insulating backing of the laminates should not be chased to accommodate services. PVC covered cables must not come into direct contact with polystyrene insulation. Suitable isolation methods such as conduit or capping should be used.

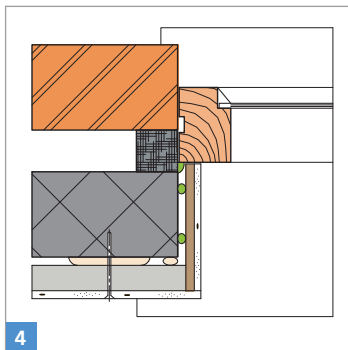

● The use of Gyproc ThermoLine PLUS is recommended at window and door reveals to minimise the risk of thermal bridging.

● Fix by direct bonding with Gyproc Sealant (one row of blobs at 300mm centres for narrow reveals, 2 rows for wider reveals).



● When the dabs have set, install Gyproc Nailable Plugs to provide secondary mechanical fixings. Insert two plugs per board, 15mm in from each edge at mid-height.

● Select plugs of sufficient length to give a 25mm nominal penetration into the solid wall and drill hole 5mm longer than the plug.

● Drive each plug in until the head is slightly below the liner without fracturing it.

Installation



DriLyner si system

Installing Gyproc TriLine

Proceed as for DriLyner BASIC system with the following exceptions:

- Mark the wall at 900mm centres to indicate board positioning.

- Prime the surface of the insulating backing with a thin layer of Gyproc Dri-Wall Adhesive just prior to positioning the boards.
- Apply the adhesive in bands, approximately 200mm wide, to the perimeter and down the centre of the laminate to coincide with the position of Gyproc Dri-Wall Adhesive dabs.

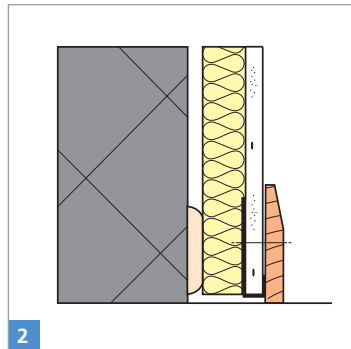

- Position dabs of Gyproc Dri-Wall Adhesive in three vertical rows to receive each board.
- Locate Gypframe Skirting Plates (optional) over the bottom board edge with rear of plate inserted between the plasterboard and insulating backing. Position at 600mm centres, 150mm in from each long edge.

- At reveals and external angles run the lining past the corner and cut back the insulating backing so as to form a neat junction with the reveal board or wall lining. The use of Gyproc ThermalLine PLUS is recommended at window and door reveals to minimise the risk of thermal bridging.
- Insert two Gyproc Nailable Plugs for each laminate 15mm in from each edge, 200mm down from the top, to provide secondary mechanical fixings.



- Select plugs of sufficient length to give a nominal 25mm penetration into the solid wall and drill hole 5mm longer than the plug.
- Drive each plug in until the head is slightly below the liner without fracturing it.

Installation

DriLyner MF system

Proceed as for DriLyner **BASIC** system with the following exceptions:

- Mark wall with lines at 600mm centres to indicate Gypframe MF10 Channel locations.



● A continuous fillet of Gyproc Dri-Wall Adhesive is applied to the wall perimeter and around services and openings as board fixing proceeds.

● Dabs of Gyproc Dri-Wall Adhesive are applied progressively to the wall to each vertical line. Gyproframe MF10 Channels are located onto the adhesive dabs and 'tapped' into position.

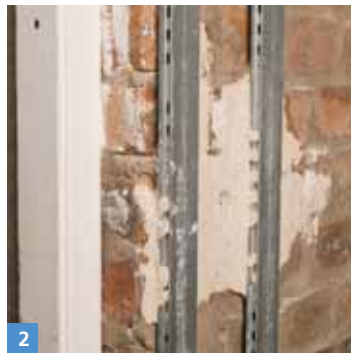

● Further vertical Gyproframe MF10 Channels are adhesive fixed to complete the run of wall.

● Consider additional channels at the position of cupboards, radiators etc.



● Horizontal channels are similarly located at the head and base.

● At angles and reveals, Gyproframe MF10 Channels are installed close to the corner to provide support. Door and window openings are framed with Gyproframe MF10 Channels.

● At window openings, the channel at the head forms a ground for fixing curtain track. Where a partition abuts, an additional Gyproframe MF10 Channel is installed to provide a fixing ground.



- Board fixing can proceed when the adhesive has fully set. Boards are positioned with the back against the Gyprframe MF10 Channels and bottom edge resting on plasterboard packing strips and lifted tight to the ceiling using a footlifter.
- Additional packing strips are inserted at the base to wedge the board in place.

- Boards are screw-fixed at 300mm centres to all Gyprframe MF10 Channel supports. Screw lengths should be selected to avoid contact with the masonry background.



- When installing Gyproc ThermaLine laminates, a continuous bead of Gyproc Sealant is gun-applied to the Gyprframe MF10 Channels just prior to positioning and screw-fixing the boards.
- Three screws should be located in each tapered edge - one at mid-height, one 600mm above and one 600mm below.
- At reveals, Gyproc ThermaLine PLUS boards are direct-bonded using Gyproc Sealant.

Installation



DriLyner RF system

Installing 1200mm width Gyproc plasterboards or Gyproc ThermaLine laminates.

Proceed as for DriLyner BASIC system with the following exceptions:

- Marking out is not required. The system should only be used where the background alignment is satisfactory.

- Gun apply blobs of Gyproc Sealant to the wall or the back of the board approximately 25mm in diameter (single squeeze), at 300mm centres in both directions.



- Ensure that the blobs adjacent to a board joint are approximately 25mm in from the edge to avoid bridging the joint.



3

- Cut board 15mm short of the floor to ceiling height. Position the first board, with the bottom edge resting on plasterboard packing strips.
- Tap the board back firmly using a straight-edge, ensuring that the vertical edge is plumb.
- Gently lift using a footlifter until the board is tight against the ceiling. Insert additional packing strips at the base to wedge the board in place and remove the footlifter.
- Continue drylining in the same manner with boards lightly butted.



4

- At internal angles cut board to fit and position the cut edge to the angle.
 - At reveals and external angles, run the lining past the corner (and, when installing Gyproc ThermalLine laminate, cut back the insulating backing) so as to form a neat junction with the reveal board or wall lining.
- NB** The use of Gyproc ThermoLine PLUS is recommended at window and door reveals to minimise the risk of thermal bridging.



5

Thermal laminates only

- Install Gyproc Nailable Plugs to provide secondary mechanical fixings. Insert two plugs per board, 15mm in from each edge at mid-height.
- Select plugs to give a nominal 25mm penetration into the solid wall (excluding plaster thickness). Drill hole 5mm longer than the plug.
- Drive in each plug until the head is slightly below the liner without fracturing it.

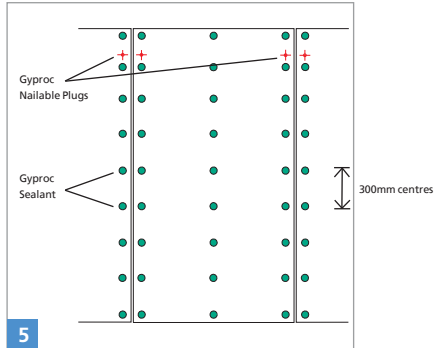

Installing Gyproc TriLine

Install as for plasterboards with the following exceptions:

- Mark the wall at 900mm centres to indicate board positioning apply blobs of Gyproc Sealant in three vertical rows to the back of the laminate and firmly flatten each blob using a taping knife to prime the surface.

- Gun apply a further blob of Gyproc Sealant over each primed area.
- Insert the two Gyproc Nailable Plugs for each laminate 15mm in from each edge, 200mm down from the top.

Metal framed wall lining system

GypLyner UNIVERSAL is a cost-effective, virtually independent metal frame drylining system for lining walls. General purpose and suitable for all internal non-loadbearing applications. This system is compatible with, and uses common components of, GypLyner UNIVERSAL ceiling lining and GypLyner ENCASE steel encasement system.



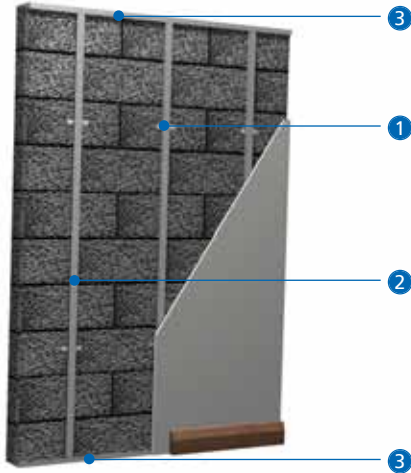

- 1 Gypframe GL2 or GL9 Bracket
- 2 Gypframe GL1 Lining Channel
- 3 Gypframe GL8 Track

Key facts

- Corrects background irregularities
- Minimal connection to the structure
- Can satisfy national Building Regulations on thermal performance and acoustic requirements
- Provides service void
- Versatile, general purpose lining
- Little or no background preparation needed
- Commonality of ceiling and wall lining components

Components**Gyproc board products**

			Take-off quantities ¹
	Gyproc WallBoard³		100m ²
	Thickness	12.5, 15mm	
	Width	1200mm	
	Gyproc SoundBloc²		100m ²
	To meet Part E regulations		
	Thickness	12.5, 15mm	
	Width	1200mm	
	Gyproc DuraLine²		100m ²
	Thickness	15mm	
	Width	1200mm	
	Gyproc ThermoLine laminates²		100m ²
	Thickness	22 - 93mm	
	Width	1200mm	

Specialist board products

	Glasroc H TILEBACKER⁴		100m ²
	Thickness	12.5mm	
	Width	1200mm	

¹ Quantities are for 100m² of straight wall lining with single layer boarding. Quantities are approximate and for guidance only. No allowance has been made for waste, openings, abutments, etc. Refer to section 12 - Quantity take-off details.

Gypframe metal products

			Take-off quantities ¹
	Gypframe GL1 Lining Channel		167m
	Length	2400, 2700, 3000, 3600mm	
	Gypframe GL2 Bracket		dependant on lining height
	Length	195mm flat (max 75mm stand-off from wall)	
	Gypframe GL9 Bracket		dependant on lining height
	Length	295mm flat (max 125mm stand-off from wall)	
	Gypframe GL3 Channel Connector		dependant on lining height
	Gypframe GL8 Track		dependant on lining height
	Length	3600mm	

² Moisture resistant boards are specified in intermittent wet use areas.

³ Also available in DUPLEX grades where a vapour check is required.



⁴ Glasroc H TILEBACKER is suitable for use in high moisture environments. For tiling guidance, refer to section 10 - Tiling.

Gypframe metal products		Take-off quantities ¹
	Gypframe 99 FC 50 Fixing Channel Length 2400mm	as required
	Gypframe 150 FC 90 Fixing Channel Length 1194mm	as required
	Gypframe GFS1 Fixing Strap Length 2400mm	as required
	Gypframe GFT1 Fixing 'T' Length 2400mm	as required

Fixing and finishing products		Take-off quantities ¹
	Gyproc Wafer Head Drywall Screws For metal-to-metal fixing up to 0.79mm thick	as required
	Gypframe GL11 GyLyner Anchors For fixing Gypframe GL2 or GL9 Brackets to concrete / masonry	as required
	Gyproc Drywall Screws For fixing boards to stud framing up to 0.79mm thick	1,100

Components

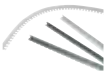
Fixing and finishing products

	Take-off quantities ¹
 Gyproc Sealant Sealing air paths for optimum sound insulation.	1 cartridge per 35m based on a 6 - 10mm bead
 Gyproc edge beads Protecting and enhancing board edges.	as required
 Gyproc Control Joint To accommodate structural movement. Length 3048mm	as required

¹ Quantities are for 100m² of straight wall lining with single layer bonding. Quantities are approximate and for guidance only. No allowance has been made for waste, openings, abutments, etc. Refer to section 12 - Quantity take-off details.

Fixing and finishing products

	Take-off quantities ¹
 Gyproc jointing materials For a seamless finish.	as required
 Thistle Multi-Finish or Thistle Board Finish To provide a plaster skim finish.	10m ² per 25kg bag
or	
 Thistle Durafinish To provide improved resistance to accidental damage.	10m ² per 25kg bag
or	
 Thistle Spray Finish Gypsum finish plaster for spray or hand application.	11m ² per 25kg bag
 Isover APR 1200 For enhanced acoustic performance. 25mm or 50mm.	as required

Construction tips

- Estimated construction time 3m² / man hour - ready for finishing
- Depth of the cavity is determined by the fixing brackets, each requiring a stand-off plus lining thickness of either 25mm - 75mm for a Gypframe GL2 Bracket and 25mm - 125mm for a Gypframe GL9 Bracket
- Keep the drylining cavity closed to prevent downgrading the thermal performance - where required apply a continuous band of Gyproc Dri-Wall Adhesive or Gyproc Sealant to the perimeter of external walls, around service penetrations, openings, junctions and around the perimeter of suspended timber floors
- Brackets to be fixed at a maximum of 800mm vertical centres
- Use full height boards where possible - if joints are unavoidable, position them above suspended ceilings or below access floor level
- Support horizontal board joints with Gypframe GFT1 Fixing 'T', or use Gypframe GFS1 Fixing Strap for double boarded linings
- Form vertical cavity barriers, where specified, in long runs of lining

Installation



● Use a straight edge (e.g. Gypframe GL1 Lining Channel) to determine the maximum undulation in the wall or service protrusion. This will determine the cavity depth.



● Mark chalk lines to the floor and ceiling to indicate the positioning of the Gypframe GL8 Track.



● Fix Gypframe GL8 Track to perimeters, with the longer leg towards the lining, at 600mm centres using appropriate fixings (see **Base detail 20**).



- Mark vertical lines on the wall at 600mm intervals to indicate bracket fixing centres.
- Mark horizontal lines at 800mm centres to determine individual bracket position.
- Use a 5.5mm drill bit to drill a 45mm minimum depth hole.
- Position each bracket, ribs to the wall, and fix through bracket slot into the masonry wall using a Gypframe GL11 GypLyner Anchor, which is a hammer fixing.



- Cut Gypframe GL1 Lining Channels to size and round-off ends with tin snips for an easier fit.
- NB** Additional Gypframe GL1 Lining Channels may be required to pick up fixings for subsequent adjacent linings (see **Junction details – 10 to 21**).
- Friction fit Gypframe GL1 Lining Channel into the track.
 - Extend GL1 Channel where required by engaging ends over a GL3 Channel Connector.



- Bend bracket legs forward and fix each leg to the channel using a Gyproc Wafer Head Drywall Screw. Insert screw through the hole in the bracket nearest to the back of the channel (see **Junction detail – 18**).
- NB** Avoid exerting any backwards or forwards pressure on the channels when screw-fixing the brackets, otherwise a straight and true lining surface may not be achieved.

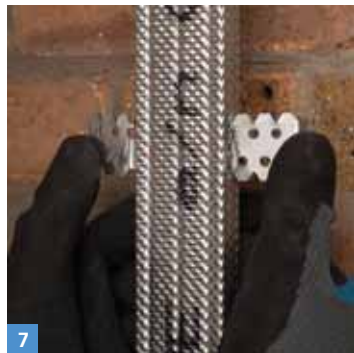

- 7
- Bend back protruding bracket legs to sit clear of the channel face.



8

Internal angles

- Position a Gypframe GL1 Lining Channel tight into the corner in order to provide support for the lining.
- Bend one bracket leg across the face of the Gypframe GL1 Lining Channel and fix with a Gyproc Wafer Head Drywall Screw to secure and restrain the channel at the corner position.



9

Board fixing

- Fix boards to all framing members at 300mm centres using Gyproc Drywall Screws from top to bottom.
 - Lightly butt boards, inserting screws not closer than 10mm from bound edges and 13mm from cut edges.
- NB** Select the appropriate length of fixing to provide a nominal 10mm penetration into the steel framing (dependent on board thickness).



- Adjacent linings to be fixed through previous plasterboard into the Gypframe GL1 Lining Channel behind.
 - Locate Gypframe GL8 Track tight to the wall at the corner position and fix through the lining into the channel.
 - Continue boarding, fixing boards to all framing members.
- NB** Adjust slotted brackets (if necessary) as boarding proceeds to allow for board width tolerances.



Openings

- Position a Gypframe Lining Channel either side of the opening to compensate for the thickness of the plasterboard to be fixed into the reveal.
- Install cut and bent track to form the head of the opening and fix to the side of the channel using two Gyproc Wafer Head Drywall Screws.



- Position short lengths of Gypframe GL1 Lining Channel above the opening for additional support and to maintain appropriate support centres, and fix using two Gyproc Wafer Head Drywall Screws.

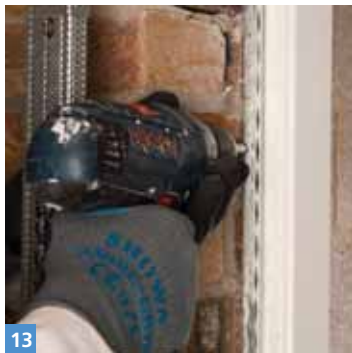

13

● Fix Gyproc edge bead to the perimeter of the window frame to provide edge protection to the reveal and soffit linings.



14

● Cut reveal and soffit boards to width, locate into the perimeter edge bead and fix to the channel.

● Fix boards to complete drylining at the opening.

NB Alternatively Gyproc ThermaLine PLUS could be fixed using Gyproc Sealant as shown in section 6 DriLyner RF. (see Junction detail – 19).



15

● Where door openings occur in the run of lining, cut board around the opening to avoid a joint directly in line with door jambs.

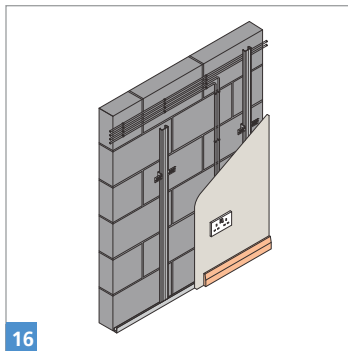

Insulation

- If Isover insulation is specified, install progressively as boarding proceeds.

NB The insulating backing of Gyproc ThermaLine laminates should not be chased to accommodate services. PVC covered cables must not come into contact with polystyrene insulation. Use suitable isolation methods (conduit or capping).

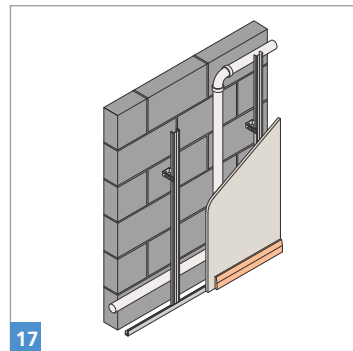

Service installations

- The drylining cavity facilitates the incorporation of services. Fix pipes and conduits in position before installing the framing.

Junction details

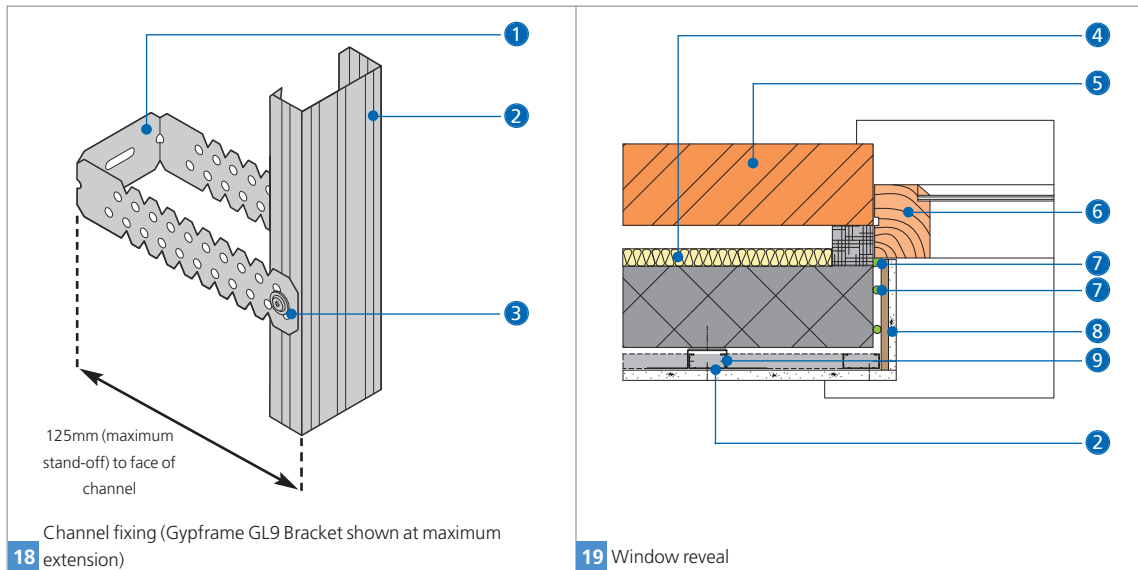

- 1 Gypframe GL9 Bracket
- 2 Gypframe GL1 Lining Channel
- 3 Gyproc Wafer Head Drywall Screw

- 4 Isover Hi-Therm partial cavity fill
- 5 Wall structure
- 6 Window unit

- 7 Gyproc Sealant
- 8 Gyproc ThermaLine PLUS
- 9 Gypframe GL2 Bracket

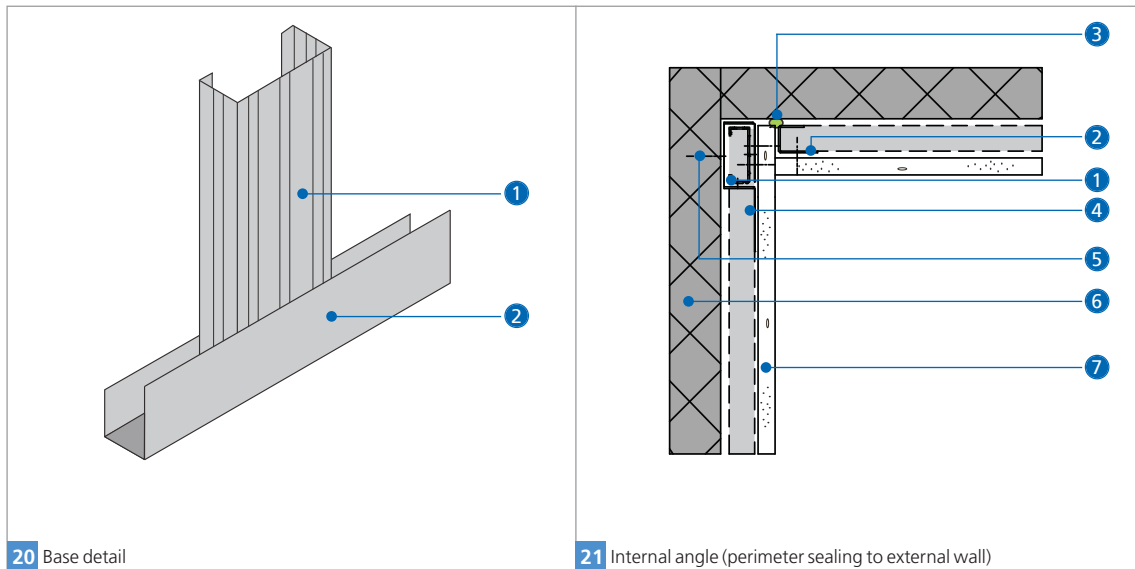

- 1 Gypframe GL1 Lining Channel
- 2 Gypframe GL8 Track
- 3 Gyproc Sealant

- 4 Gypframe GL2 Bracket
- 5 Gypframe GL11 GypLyner Anchor
- 6 Wall structure

- 7 Gyproc plasterboard lining

Junction details

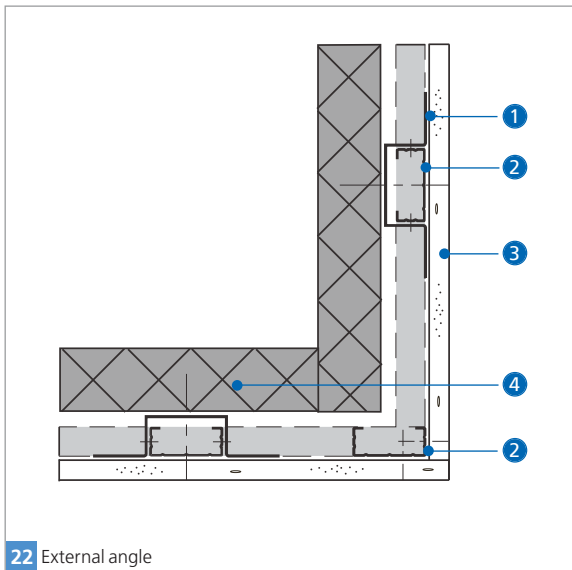

- 1 Gypframe GL2 Bracket
- 2 Gypframe GL1 Lining Channel
- 3 Gyproc plasterboard lining
- 4 Wall structure

Independent wall lining system

GypLyner iWL independent wall lining is a lightweight, non-loadbearing drylining which is erected independently of the external wall construction. The system is used in all types of building, but is particularly suitable for those with reinforced concrete or steel frames. The lining provides fire resistance to structural steel sections within the lining cavity and can be used to increase sound insulation and meet thermal performance requirements of new or existing masonry walls.



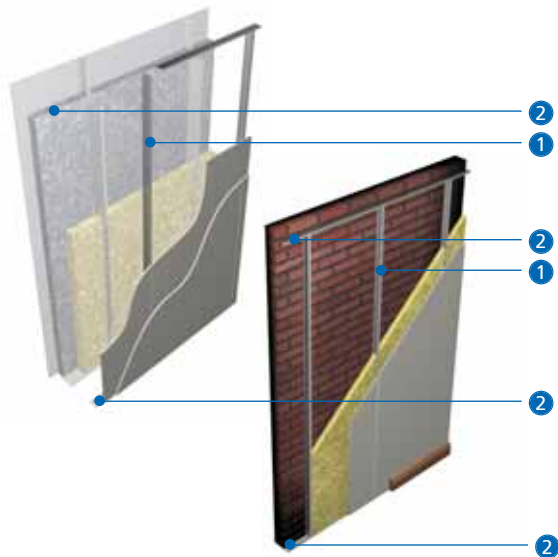



Key facts

- Fully independent wall lining
- Compatible with external wall constructions including curtain walling, rain screen claddings, industrial claddings, brickwork and glazed atriums
- Used to line non fire-rated service risers
- Satisfies *BS 5234* strength and robustness requirements up to Severe Duty
- Provides fire protection to structural steelwork
- Provides fire resistance in association with external structure
- Used to upgrade the sound and thermal performance of an existing masonry wall
- Provides service void

Components**Gyproc board products**

			Take-off quantities ¹
	Gyproc WallBoard^{2,3}		100m ² per layer
	Thickness	12.5, 15mm	
	Width	900, 1200mm	
	Gyproc FireLine³		100m ² per layer
	Thickness	12.5, 15mm	
	Width	1200mm	
	Gyproc SoundBloc²		100m ² per layer
	Thickness	12.5, 15mm	
	Width	1200mm	
	Gyproc DuraLine²		100m ² per layer
	Thickness	15mm	
	Width	1200mm	
	Gyproc ThermaLine laminates²		100m ² per layer
	Thickness	22 - 93mm	
	Width	1200mm	



¹ Quantities are for 100m² of straight wall lining with double layer boarding. Quantities are approximate and for guidance only, no allowance has been made for waste, openings, abutments, etc.

² Moisture resistant boards are specified in intermittent wet use areas.

Specialist board products

			Take-off quantities ¹
	Glasroc H TILEBACKER⁵		100m ² per outer layer
	Thickness	12.5mm	
	Width	1200mm	

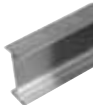
Gypframe metal products

	Gypframe 'I' Studs		167m
	Width	48, 60, 70, 92, 146mm	
	Length	2700 - 6000mm	
	Codes	48 I 50, 60 I 50, 60 I 70, 70 I 70, 92 I 90, 146 I 80	
	Gypframe 'C' Studs		as required
	Width	48, 60, 70, 92, 146mm	
	Length	2400 - 4200mm	
	Codes	48 S 50, 60 S 50, 70 S 50, 92 S 50, 146 S 70	

³ Also used in DUPLEX grades where a vapour check is required.

⁴ Gypframe DC (Deep Flange) and EDC (Extra Deep Flange) Floor & Ceiling Channel are available in selected sizes for deflection head and increased height applications.



⁵ Glasroc H TILEBACKER is suitable for use in high moisture environments. For tiling guidance, refer to section 10 - Tiling.

Gypframe metal products		Take-off quantities ¹
	Gypframe Standard Floor & Ceiling Channel⁴ Width 50, 62, 72, 94 and 148mm Length 3600mm Codes 50 C 50, 62 C 50, 72 C 50, 94 C 50 and 148 C 50	dependent on partition length
	Gypframe 99 FC 50 Fixing Channel Length 2400mm	as required
	Gypframe 150 FC 90 Fixing Channel Length 1194mm	as required
	Gypframe GFS1 Fixing Strap Length 2400mm or GFT1 Fixing 'T' Length 2400mm	as required





Gypframe metal products		Take-off quantities ¹
	Gypframe GA6 Splayed Angle Length 2400, 3600mm	as required
	Gypframe GA5 Internal Fixing Angle Length 3600mm	as required
	Gyproc Drywall Screws For fixing boards to stud framing up to 0.79mm thick.	1st layer - 900 2nd layer - 1100
	Gyproc Jack-Point Screws For fixing boards to stud framing 0.8mm thick or greater and 'I' studs greater than 0.55mm thick.	as above
	Gyproc Sealant Sealing air paths for optimum sound insulation.	1 cartridge per 35m based on a 6 - 10mm bead
	Gyproc edge beads Protecting and enhancing board edges.	as required

Components

Fixing and finishing products

		Take-off ¹ quantities
	Gyproc FireStrip For fire-stopping deflection heads.	as required
	Gyproc Profilex Access Panels Access to services for maintenance.	as required
	Gyproc jointing materials For a seamless finish.	as required

Fixing and finishing products

		Take-off ¹ quantities
	Thistle Multi-Finish or Thistle Board Finish To provide a plaster skim finish.	10m ² per 25kg bag
	or	
	Thistle Durafinish To provide improved resistance to accidental damage.	10m ² per 25kg bag
	or	
	Thistle Spray Finish Gypsum finish plaster for spray or hand application.	11m ² per 25kg bag
	Isover Acoustic Slab - High Performance 50mm and 75mm, for improved acoustic and thermal performance.	as required

¹ Quantities are for 100m² of straight wall lining with double layer boarding. Quantities are approximate and for guidance only, no allowance has been made for waste, openings, abutments, etc.

Construction tips

- Estimated construction time 3m² / man hour (single layer lining) or 2m² / man hour (double layer lining) ready for finishing
- All parts of the lining system (including thermal insulation) should remain independent of the external walling - position lining so a continuous cavity remains between the back of the insulation and the external walling
- Fire resistance is primarily to structural steel located between the lining and external cladding, but can also contribute to fire protection of the complete wall structure when the inside of the wall is exposed to fire (dependent on wall construction)
- Keep the drylining cavity closed to prevent downgrading the thermal performance - where required, apply a continuous bead of Gyproc Sealant to the perimeter of external walls, around service penetrations, openings, junctions and around the perimeter of suspended timber floors

Installation

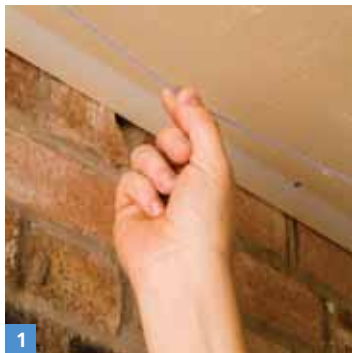

- Mark lines to indicate the position of the lining framework from the highest point on the background.

NB On uneven floors a timber sole plate, 38mm x width of stud, may be required. On new concrete screeding consider installing a damp proof membrane to the full partition width before locating the sole plate or floor channel.



- Locate Gypframe Floor & Ceiling Channel **up to** the floor and ceiling lines. Use DC (Deep Flange) channel at head and base if lining height is between 4200mm and 8000mm.

- Fix Gypframe 'C' Studs to abutments, junctions and openings only.



- Position the Gypframe 'I' Studs vertically between channel sections and twist to locate.



Board fixing - single layer

- Fix boards to all framing members at 300mm centres using the appropriate length Gyproc screws.
- Reduce centres to 200mm at external angles.



- Lightly butt boards, inserting screws not closer than 10mm from bound edges and 13mm from cut edges.



- Where door openings occur, cut boards around the opening to avoid a joint directly in line with door jambs.



7

Board fixing - multi-layer

- Under-layer boards do not require centre fixings. Cut and fix the initial second layer board as appropriate so that subsequent board joints are staggered.

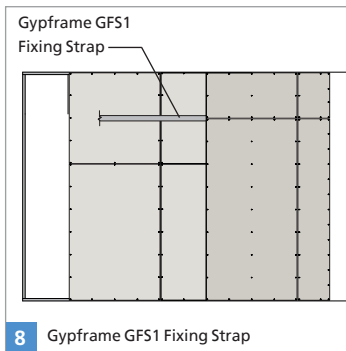

8 Gypframe GFS1 Fixing Strap

- Typical double layer board configuration is as above.

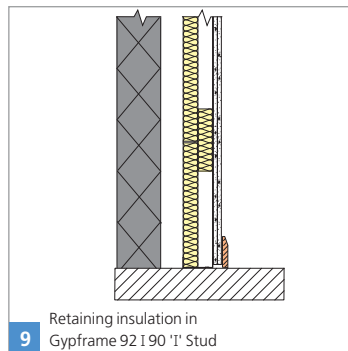

9 Retaining insulation in Gypframe 92 I 90 'I' Stud

Acoustic insulation

- Install Isover Acoustic Slab - High Performance to a friction fit within the stud cavity. The slabs are self-supporting, receiving internal support from the stud flanges. Where 50mm insulation is fitted into Gypframe 92 I 90 'I' Studs. We recommend a 150mm x 50mm strip of Isover High Performance Slab is inserted to retain the slab. With Gypframe 146 I 90 'I' Studs, two strips of Isover will need to be inserted to retain the slab.

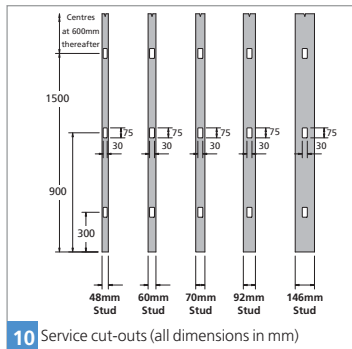

Services

- The stud cut-outs can be used for services provided that there is no undue disturbance of the Isover insulation.
 - Locate surface mounted trunking against the plasterboard lining, and fix through the lining to the stud framework.
- NB** Any penetration in the lining may downgrade its performance.

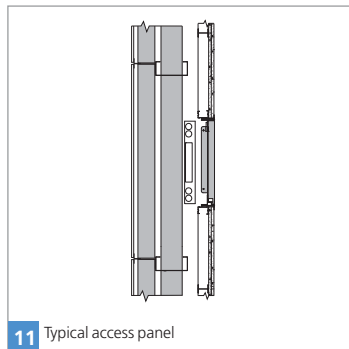

- Horizontal and vertical services can be included behind the lining, accessed via a Gyproc Proflex Access Panel (fire-rated if specified).

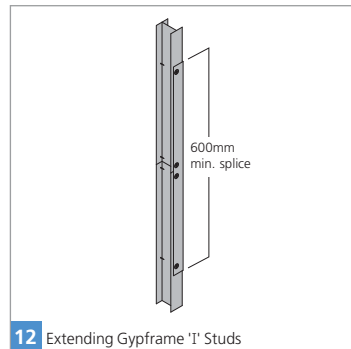

- NB** Where the wall height exceeds the available length of Gypframe 'I' Stud, sections of stud can be spliced together to the required length using 600mm lengths of the appropriate Floor & Ceiling Channel fixed with four Gyproc Wafer Head Screws in each flange to each side of the stud.

Junction details

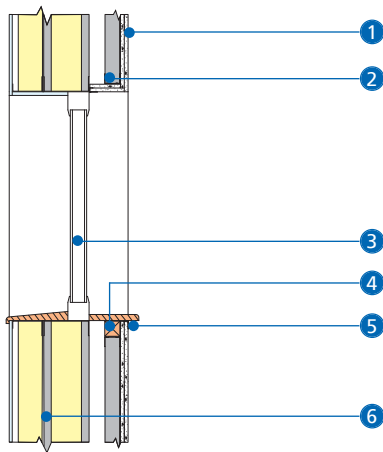

Window opening (vertical section)

13 **NB** Ensure board joints are staggered

- 1** Gyproc plasterboard
- 2** Gypframe Floor & Ceiling Channel
- 3** Window unit
- 4** Timber head piece
- 5** Gyproc Edge Bead
- 6** External wall construction

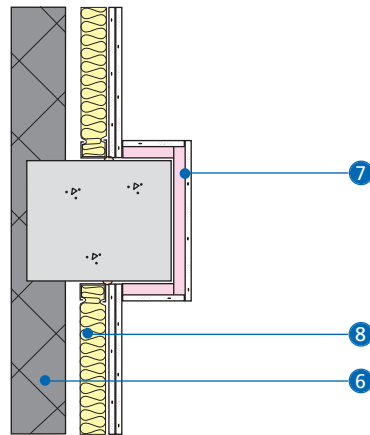

14 Typical internal cladding to concrete column

- 7** Gyproc ThermaLine laminate
- 8** Isover Acoustic Slab - High Performance

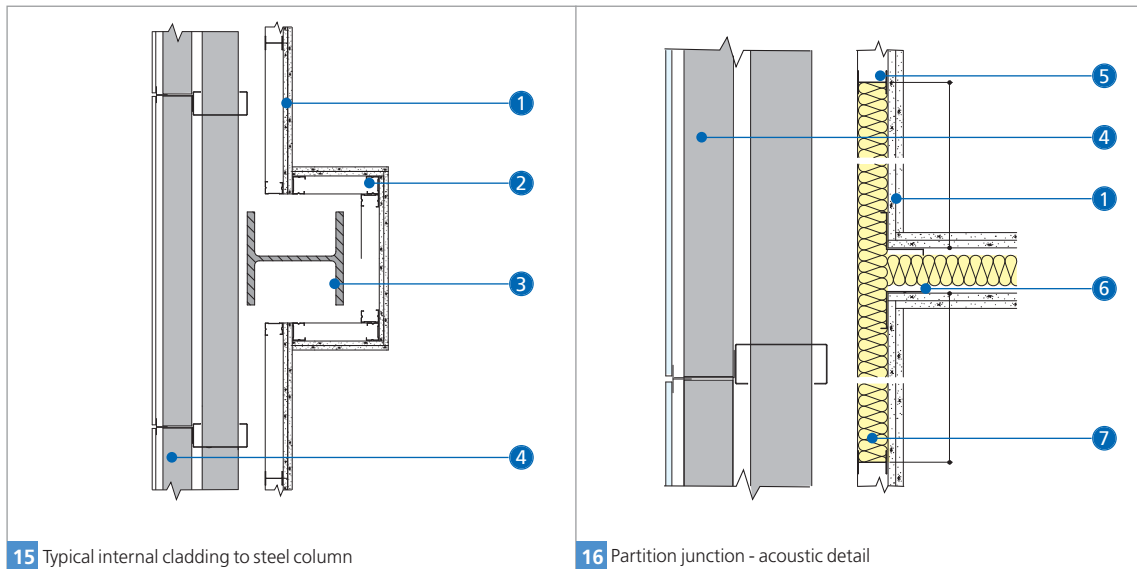

15 Typical internal cladding to steel column

16 Partition junction - acoustic detail

- 1 Gyproc plasterboard
- 2 Gypframe 'C' Studs
- 3 Steel column

- 4 External wall construction
- 5 Gypframe 'I' Stud
- 6 Gypframe GA5 Internal Fixing Angle

- 7 Isover Acoustic Slab - High Performance

Industrial fire-resistant lining system

FlameLyner is used to line the external walls of steel framed industrial buildings. The system is often installed above a 2-3m high loadbearing block wall. It can be used in most types of industrial property including factories, warehouses and industrial units.

For further installation guidance on specialist systems, please refer to the British Gypsum website www.british-gypsum.com

Alternatively, contact the British Gypsum Drywall Academy Advice Centre on 0800 800 1991.



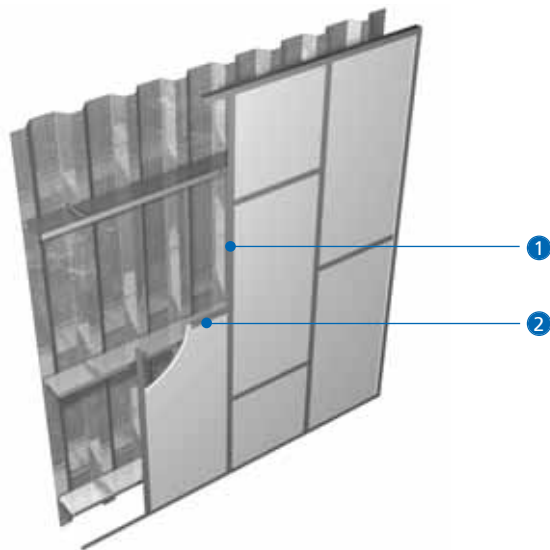

1 Gypframe GT1 Main 'T'

2 Gypframe GT2 Cross 'T'

Key facts

- Durable industrial lining
- Glasroc FlameLine provides an exceptionally smooth surface
- Provides an inside sheeting rail lining
- Uses lightweight 'T' sections
- Provides a high level of fire resistance

Concealed grid MF suspended ceiling system

Casoline MF is a suspended ceiling system suitable for most internal drylining applications. The grid is fully concealed and the ceiling lining is joint-treated or plastered to present a seamless, monolithic appearance.



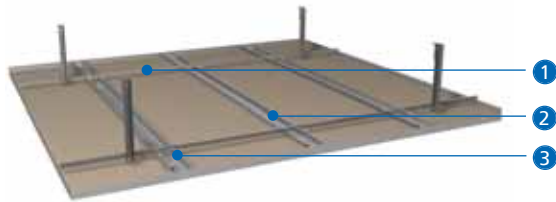

- 1 Gypframe MF7 Primary Support Channel
- 2 Gypframe MF5 Ceiling Section
- 3 Gypframe MF9 Connecting Clip

Key facts

- Monolithic appearance
- Suspension from concrete or timber floors
- Acoustic hangers provide option of resilient suspension
- Durable ceiling lining
- Ventilation ducts and other services accommodated in plenum
- Access panels provide services access
- Easy to create bulkheads and change levels

Components
Gyproc and Glasroc board products

			Take-off quantities ¹
	Gyproc WallBoard^{2,3} Thickness 12.5, 15mm Width 900, 1200mm		100m ²
	Gyproc SoundBloc² Thickness 12.5, 15mm Width 1200mm		100m ²
	Gyproc FireLine^{2,3} Thickness 12.5, 15mm Width 900, 1200mm		100m ²
	Glasroc MultiBoard Thickness 6, 10, 12.5mm Width 1200mm		100m ²

¹ Quantities are for 100m² of regular shaped rectangular ceiling, with a 1m depth of suspension. Quantities are based on a maximum recommended load on the CasoLine ceiling grid (including the weight of the board) of 30kg/m² MF5 component at 450mm centres. Quantities are approximate for a single layer installation and for guidance only, no allowance has been made for waste.

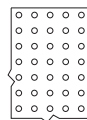
Arteco ceiling products

Arteco Gyptone board products
and
Arteco Rigitone board products

Take-off quantities¹

as required

Gypframe metal products

Gypframe MF5 Ceiling Section
Main support section.
Prime dimensions 80 x 26mm
Gauge 0.5mm
Length 3600mm

230m



Gypframe MF6 Perimeter Channel
Perimeter support for MF5s.
Prime dimensions 20 x 28 x 30mm
Gauge 0.5mm
Length 3600mm





varies depending on the ceiling perimeter

Refer to section 11 – Quantity take-off details.

² Moisture resistant boards are specified in intermittent wet use areas e.g. shower cubicles.

³ Also available in DUPLEX grades where vapour control is required.

Gypframe metal products		Take-off quantities ¹
	<p>Gypframe MF7 Primary Support Channel Primary support for MF5s. Prime dimensions 15 x 45mm Gauge 0.9mm Length 3600mm</p>	83m
	<p>Gypframe MF8 Strap Hanger Suspension of ceiling grid. Prime dimension 25mm Gauge 0.55mm Length 25m (coil)</p>	64m
or		
	<p>Gypframe GA1 Steel Angle Width 25 x 25mm Gauge 0.5mm Length 2900mm</p>	64m
or		
	<p>Gypframe GAH1 Acoustic Hanger Length 35mm</p>	70 where specified
	<p>Gypframe GAH2 Acoustic Hanger Length 70mm</p>	



Gypframe metal products		Take-off quantities ¹
	<p>Gypframe MF9 Connecting Clip Fixing MF5s to MF7. Gauge 2.65mm</p>	190
	<p>Gypframe MF11 Nut and Bolt Joining hanger to soffit cleat. Dimensions 6 x 12mm bolt</p>	100
	<p>Gypframe MF12 Soffit Cleat Suspension point from structural soffit. Prime dimensions 27 x 37 x 25mm Gauge 1.6mm</p>	70
Fixing and finishing products		
	<p>Gyproc Profiflex Access Panels For access to the plenum for maintenance purposes.</p>	as required
	<p>Gyproc Drywall Screws For fixing boards to framing up to 0.79mm thick.</p>	1800

Components

Fixing and finishing products

		Take-off quantities [†]
	Gyproc Wafer Head Drywall Screws For metal-to-metal fixing up to 0.79mm thick.	as required
	Gyproc Wafer Head Jack-Point Screws For metal-to-metal fixing 0.8mm thick or greater.	as required
	Gyproc Sealant For sealing air paths to achieve optimum sound insulation.	1 cartridge per 35m based on 6-10mm bead
	Thistle Multi-Finish or Thistle Board Finish To provide a plaster skim finish.	10m ² per 25kg bag
	Thistle Spray Finish Gypsum finish plaster for spray or hand application.	11m ² per 25kg bag
	Isover General Purpose Roll For providing acoustic / thermal insulation.	as required

Fixing and finishing products

		Take-off quantities [†]
	Isover Modular Roll For providing acoustic / thermal insulation.	as required
	Isover Frame Batt 32 For providing acoustic / thermal insulation.	as required
	Stone Mineral Wool For providing fire performance.	as required
	Gyproc jointing materials For seamless jointing.	as required

[†] Quantities are for 100m² of regular shaped rectangular ceiling, with a 1m depth of suspension. Quantities are based on a maximum recommended load on the Casoline ceiling grid (including the weight of the board) of 30kg/m² MF5 component at 450mm centres. Quantities are approximate for a single layer installation and for guidance only, no allowance has been made for waste.

Construction tips

- Estimated construction time 1.5m²/ man hour (single layer ceiling) or 1 m²/ man hour (double layer ceiling) ready for finishing
- Recommended board size is 900mm x 1800mm. If longer boards are specified, lift and hold against ceiling grid using a suitable board jack
- Ascertain ceiling height required and set out accordingly
- Plan the ceiling layout. Fixing points for suspending the metal grid are required at 1200mm centres in each direction. Suitable fixing devices should be employed when fixing to the structure.
- Make provision for an adequate flexible seal between ceiling and walls to counter shrinkage gaps
- Install services before fixing the framework
- Install a vapour control layer, if required, to reduce the risk of interstitial condensation
- Install cavity barriers where specified
- Steel angle provides a more robust suspension support than strap hangers. Gypframe GA1 Steel Angle is thus the required suspension option when a plaster finish is specified

Construction tips (cont'd)

- The MF ceiling grid will accept a degree of loading. Suspension and MF7 centres may require closing down – refer to the British Gypsum **WHITE BOOK**, available to download from www.british-gypsum.com
- Pre-determine the position of fixtures and fittings. Fixings must be made into the grid or to supplementary framing
- Gyproframe acoustic hangers can be used to suspend the grid from timber joists to maximise the degree of acoustic isolation. With concrete floors the high mass of the construction means that high levels of acoustic performance can be achieved when the **Casoline MF** ceiling is suspended by conventional means i.e. strap hangers or angle section
- Consider installing a standard or fire-rated Gyproc Profiflex Access Panel at access points (600 x 1200mm maximum size)
- Airtightness is essential for optimum sound insulation. Gaps at the perimeter of the ceiling, and other small airpaths, can be sealed using Gyproc Sealant
- Consider sound absorption requirements. Gyptone boards provide sound absorption when used in conjunction with an air space behind a ceiling
- Gyproc Control Joints may be required in the ceiling to relieve stresses induced by expansion and contraction of the structure. It is recommended that they coincide with movement joints within the surrounding structure

Construction tips (cont'd)

Ceiling lift

Changes to Building Regulations Approved Document L, airtightness requirements within dwellings, can lead to greater changes in air pressure when a door is opened. The ceiling is normally the lightest fixed element in the room, and therefore most likely to be affected by this change in pressure.

This can cause the ceiling to lift, which may create a noise. Whilst this noise can be annoying to the occupier, it has no detrimental effect on the performance of the ceiling.

The designer should consider incorporating a pressure release system to minimise the risk of ceiling lift. Where sufficient 'pressure relief' cannot be designed in, it is recommended that the Gypframe MF5 Ceiling Section and the Gypframe MF7 Primary Support Channel should be screw-fixed together using two Gyproc Wafer Head Jack-Point Screws at each intersection, particularly where non-perforated board linings are specified.

Installation



- Determine the required ceiling level and mark the position of Gypframe MF6 Perimeter Channel on the walls.
- Fix Gypframe MF6 at 600mm centres, using appropriate fixings.
- Mark fixing points of Gypframe MF12 Soffit Cleats to the structure at 1200mm centres (to form a 1200 x 1200mm grid). Secure each cleat using appropriate fixing.
- Pre-cut Gypframe MF8 Strap Hangers or Gypframe GA1 Steel Angle to the approximate depth of suspension required. Pre-punch or pre-drill to facilitate fixing to soffit cleat.



2

- Locate each strap hanger or angle section against a Gypframe MF12 Soffit Cleat and fix using a Gypframe MF11 Nut and Bolt.

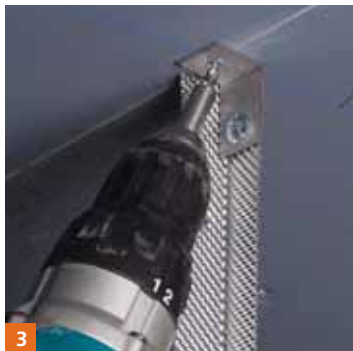

3

- Screw-fix to the structure.

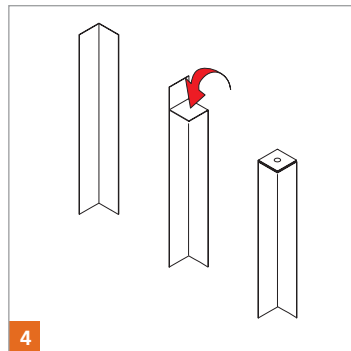

4

- Alternatively, Gypframe GA1 Steel Angle can be cut, bent and drilled to facilitate direct fixing to the structure (maximum loads will be reduced by 25% if using this method).

For double layer ceilings the Gypframe GA1 Steel Angles are fixed at max. 1200mm centres, but the Gypframe MF7s are closed down to 900mm max. centres.

Gypframe GA1 Steel Angles must not be fixed direct to the soffit if the ceiling is likely to deflect, e.g. due to varying pressures.

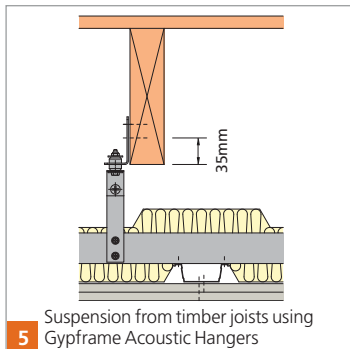

- Mark fixing points of Gypframe GAH2 Acoustic Hangers to the timber joists at 1200mm centres (to form a 1200mm x 1200mm grid). Secure each hanger using two Gyproc Drywall Timber Screws. Fix a Gypframe MF12 Soffit Cleat to the Gypframe Acoustic Hanger using an M6 Bolt, washers and locking nut.



Suspension from concrete soffit using Gypframe Acoustic Hangers

- Mark fixing points of Gypframe GAH1 or GAH2 Acoustic Hangers to the structure at 1200mm centres (to form a 1200mm x 1200mm grid). Secure each hanger with a suitable proprietary concrete fixing including steel washers to ensure fixing does not pull through acoustic rubber.

NB When fixing through plasterboard ceiling into timber joist, use suitable wood screw and washers.



- Begin to form the primary grid by fixing the first Gypframe MF7 Support Channel. Rest one end on the top flange of the perimeter channel.



8

- Fix hangers (two fixings per hanger) to Gypframe MF7 Primary Support Channel using Gypframe Wafer Head Jack-Point Screws.



9

- Extend Gypframe MF7 channels by overlapping back-to-back by 150mm minimum and fix together using two Gypframe Wafer Head Jack-Point Screws.
- Fix further Gypframe MF7 channels to complete the primary grid.



10

- Form the secondary grid by running Gypframe MF5 Ceiling Section at right angles to the underside of the primary grid at maximum 450mm centres, engaging into Gypframe MF6 Perimeter Channel at the perimeter.
- Screw-fix the Gypframe MF5 to the Gypframe MF7 using two Gyproc Wafer Head Jack-Point Screws.

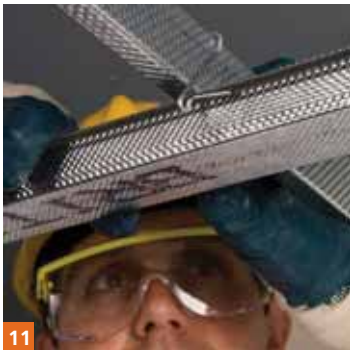

- Alternatively connect Gypframe MF5 to Gypframe MF7 using Gypframe MF9 Connecting Clips.

NB Consider construction tip on page 297 on 'ceiling lift'.



- Use a cut piece of Gypframe MF7 (or similar) to facilitate engagement of the second leg of the clip.
- Do not squeeze the Gypframe MF5 Ceiling Section.



- Extend Gypframe MF5 sections (overlapping by 150mm minimum) and crimp or screw-fix twice through each flange.
- Ensure that joints do not occur at the intersection of Gypframe MF5 and Gypframe MF7 sections, otherwise engagement of the Gypframe MF9 clip will be impaired.



14

- Install further Gypframe MF5 sections to complete the grid.



15

Fixtures

- Install additional Gypframe MF5 section, close down suspension centres or install supplementary framing, as required, to support fixtures and fittings.

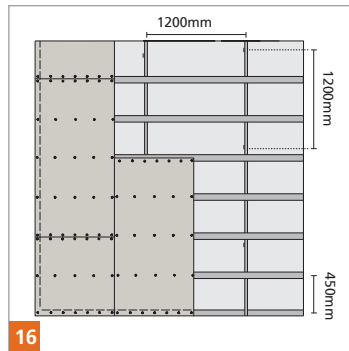

16

Fixing Gyproc boards

- Fix boards to Gypframe MF5 sections with long edges at right angles to the framing using Gyproc Drywall Screws. Lightly butt board ends inserting fixings not closer than 10mm from bound board edges and 13mm from cut edges. Stagger end joints.
- Insert screws at 230mm maximum centres in the field of boards and 150mm maximum centres at board ends.

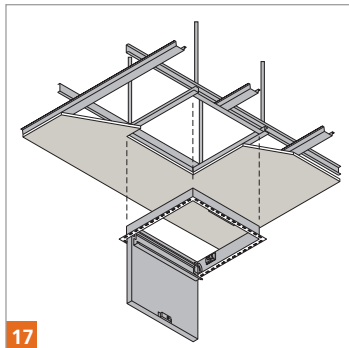

17

- For double layer linings stagger board joints in the second layer relative to the first.

NB Consideration should be given to any unevenness of the perimeter walls. The high and low spots could be established by use of a chalk line and the framing out and boarding procedure should be adjusted accordingly.

Installing access panels

- Fix a standard or fire-rated Gyproc Proflex Access Panel, if specified (see Section 12 – Products).

Services

- Route all services including ducting, pipework, electrical cables and conduit, within the plenum.

NB Consideration must be given to maintaining the integrity of the ceiling to meet fire resistance and sound insulation requirements.



18

Fixing Gyptone and Rigitone boards

- For installation details covering Arteco Gyptone and Arteco Rigitone boards, refer to the British Gypsum Ceilings Installation Guide, available to download from www.british-gypsum.com

Junction details

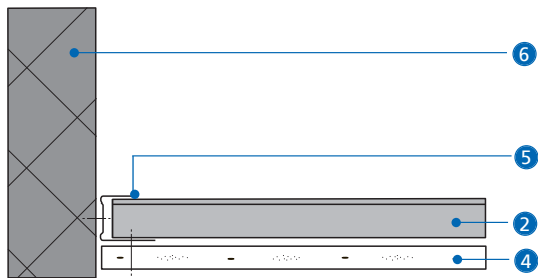

19 Perimeter fixing Gypframe MF5 Ceiling Section

- 1 Gypframe MF8 Strap Hanger or Gypframe GA1 Steel Angle
- 2 Gypframe MF5 Ceiling Section
- 3 Gypframe MF7 Primary Support Channel
- 4 Ceiling boards

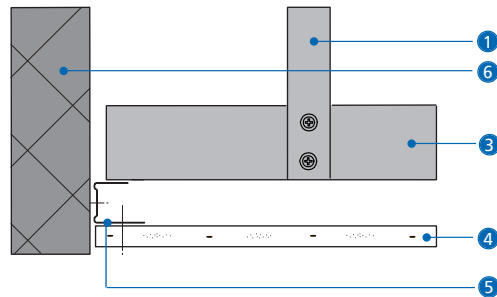

20 Perimeter arrangement - Gypframe MF7 Primary Support Channel

- 1 Gypframe MF8 Strap Hanger or Gypframe GA1 Steel Angle
- 2 Gypframe MF5 Ceiling Section
- 3 Gypframe MF7 Primary Support Channel
- 4 Ceiling boards
- 5 Gypframe MF6 Perimeter Channel
- 6 Wall structure

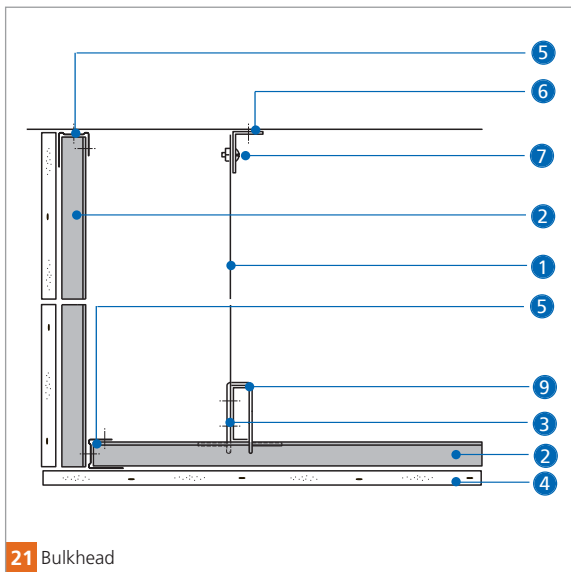

- 1 Gypframe MF8 Strap Hanger or Gypframe GA1 Steel Angle
- 2 Gypframe MF5 Ceiling Section
- 3 Gypframe MF7 Primary Support Channel
- 4 Ceiling boards
- 5 Gypframe MF6 Perimeter Channel

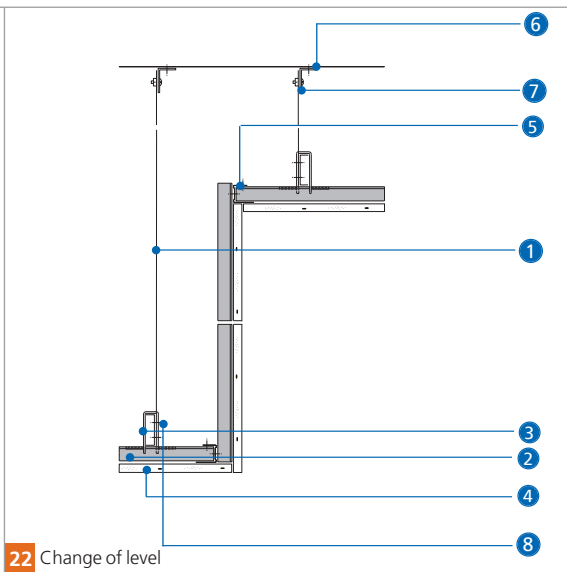

- 6 Gypframe MF12 Soffit Cleat
- 7 Gypframe MF11 Nut and Bolt
- 8 Gyproc Wafer Head Jack-Point Screw
- 9 Gypframe MF9 Connecting Clip

Concealed grid MF curved ceiling system

CasoLine **CURVE** is a lightweight non-loadbearing, suspended ceiling system for constructing curved ceiling and soffit linings. It can be used on convex or concave structures to achieve the required radii. The linings are simple to install and can be used in all types of buildings. **CasoLine CURVE** is a non fire-rated system.







1 Gypframe MF7C Curved Support Channel / Gypframe MF8 Strap Hanger

Key facts

- Can be used on concave or convex structures
- Minimum radii 600mm
- Uses pre-formed curved support channel
- No board pre-wetting required
- Durable linings
- Normal jointing techniques apply

Components**Gyproc and Glasroc products**

			Take-off quantities ¹
	Gyproc WallBoard		100m ²
	Thickness	9.5, 12.5, 15mm	
	Width	900mm	
	Gyproc SoundBloc		100m ²
	Thickness	12.5, 15mm	
	Width	1200mm	
	Glasroc MultiBoard		100m ²
	Thickness	6mm	
	Width	1200mm	



Gypframe metal products

	Gypframe MF5 Ceiling Section		325m
	Main support section.		
	Prime dimensions	80mm x 26mm	
	Gauge	0.5mm	
	Length	3600mm	

¹ Quantities are for 100m² of regular shaped rectangular ceiling. Quantities are approximate, for a single layer installation with MF5 component at 300mm centres, and for guidance only, no allowance has been made for waste.









² Assuming drop in curve from 1m to 2m.

Gypframe metal products

			Take-off quantities ¹
	Gypframe MF6 Perimeter Channel		Varies depending on ceiling perimeter
	Perimeter support for MF5's.		
	Prime dimensions	20mm x 27mm x 30mm	
	Gauge	0.5mm	
	Length	3600mm	
	Gypframe MF7C³ Curved Support Channel		180m
	Primary support for MF5's.		
	Prime dimensions	15mm x 45mm	
	Gauge	0.9mm	
	Length	3600mm ⁴	
	Gypframe MF8 Strap Hanger²		300m
	Suspension of ceiling grid.		
	Prime dimension	25mm	
	Gauge	0.55mm	
	Length	25m (coil)	

³ Supplied pre-formed to radii required and subject to special order.

⁴ Gypframe MF7C curved support channel of between 600mm and 1000mm are supplied in lengths of 2000mm

Gypframe metal products		Take-off quantities ¹	Fixing and finishing products		Take-off quantities ¹	
	Gypframe GA1 Steel Angle²	300m		Gyproc Wafer Head Drywall Screws	as required	
	Width			25mm x 25mm		For metal-to-metal fixing up to 0.79mm thick.
	Gauge			0.55mm		
	Gypframe MF11 Nut and Bolt	100		Gyproc Wafer Head Jack-Point Screws	as required	
	Joining hanger to soffit cleat.			For fixing hanger to Gypframe MF7.		
	Gypframe MF12 Soffit Cleat	100		Gyproc Sealant	1 cartridge per 35m based on a 6 - 10mm bead	
	Suspension point from structural soffit.			Sealing airpaths to achieve optimum sound insulation.		
	Prime dimensions			27mm x 37mm x 25mm		Gyproc jointing materials
Gauge	1.6mm	For seamless jointing.				
Fixing and finishing products				Thistle Multi-Finish or Thistle Board Finish	10m ² for 25kg bag	
	Gyproc Drywall Screws	1250		To provide a plaster skim finish.		
	For fixing boards to stud framing up to 0.79mm thick.			Thistle Spray Finish		11m ² for 25kg bag
				Gypsum finish plaster for spray or hand application.		

Construction tips

- The following points should be considered in addition to the general planning guidance given in **CasoLine MF**
- Estimated construction time $1\text{m}^2 - 1.5\text{m}^2 / \text{man hour}$ (single layer ceiling) or $0.5\text{m}^2 - 1\text{m}^2 / \text{man hour}$ (double layer ceiling) ready for finishing
- Board joints should be avoided on the apex of a convex curve for the exposed layer of board. Gypframe MF5 Ceiling Section positions, therefore, should be pre-determined at the design stage
- Consider the degree of curvature required. The minimum radius will be influenced by the board characteristics, the length of curve, the support centres, and the occurrence of board joints (see **Table 1**)
- For installation of Artec Gyptone and Artec Rigitone boards refer to the British Gypsum Ceilings Installation Guide
- Where the radius is greater than 3000mm, standard **CasoLine MF** procedures apply

Table 1 - Minimum radii and framing centres

Board type	Thickness mm	Minimum radius ¹ mm	MF5 ³ centres mm	Span (suspension points) of MF7C ⁴ mm	MF7C ⁴ centres mm
Glasroc MultiBoard	6	600	300	900	1200
	12 (2 x 6)	600	300	600	1200
Gyptone QUATTRO 41	12.5	6000	300	900	1200
Gyptone QUATTRO 45	12.5	6000	300	900	1200
Gyptone QUATTRO 46	12.5	6000	300	900	1200
Gyptone QUATTRO 47	12.5	6000	300	900	1200
Gyptone LINE 6	12.5	6000	300	900	1200
Gyptone LINE 7 Curve	6.5	1200	300	1200	1200
Gyptone BASE Curve ²	6.5	1200	300	1200	1200
Rigitone boards (all)	12.5	5000	330	900	1000
Gyproc WallBoard	9.5	1800	300	750	1200
	12.5	3600	300	600	1200
	15	4800	300	600	1200
Gyproc SoundBloc	12.5	2900	300	600	1200
	15	3600	300	600	1200
Gyproc FireLine	12.5	4800	300	600	1200
	15	5700	300	600	1200

¹ Concave or convex.

² Gyptone BASE Curve board is used in conjunction with Gyptone LINE 7 Curve to create non-perforated areas, e.g. around perimeters.

³ Gyproframe MF5 Ceiling Section.

⁴ Gyproframe MF7C Primary Support Channel.

NB It is not possible to bend Rigidur H board.

Installation



Suspension from concrete soffit

Install CasoLine CURVE ceiling as per CasoLine MF with the following exceptions. Because of the nature of this method of construction, it may be necessary for detail to be evolved on-site. It is important to ensure that the frame to which this board is to be fixed is reasonably rigid.



1

- Mark lines on the perimeter to the curvature required.
- Cut and fix Gypframe MF6 Perimeter Channel to the perimeter following the line of the curve.

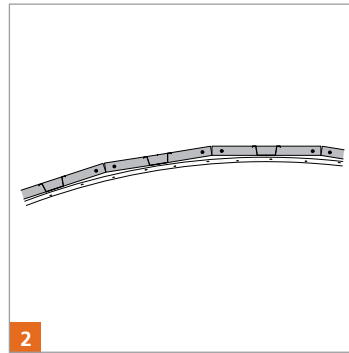

2

- Insert screws either side of the cut Gypframe MF6 Perimeter Channel and at intervals in between (if required) to achieve 300mm maximum fixing centres.

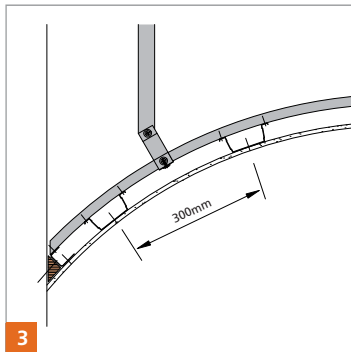

- Where the curved ceiling abuts the wall, a timber fillet is required.

NB In any event the termination of any curved sections must be stabilised to ensure the ceiling framework is rigid prior to board fixing.



- Fix the Gypframe MF12 Soffit Cleats to the structure at the support centres shown in **Table 1** on the line of the Gypframe MF7C Curved Support Channel sections, which are fixed at 1200mm centres. The Gypframe MF12 Soffit Cleat centres are closer than normal to take account of the curvature of the Gypframe MF7C section (see **Junction details**).

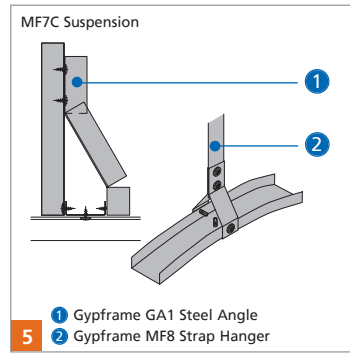

- Drop Gypframe MF8 Strap Hanger or Gypframe GA1 Steel Angle and connect to the Gypframe MF7C. Adopt one of the alternative methods shown above.

- Fix hangers directly to the side of joists using two Gyproc Drywall Timber Screws spaced 25mm apart. The lower fixing should be 25mm **minimum** from the bottom of the joist.

NB **Suspension from timber joists**

The procedure is as for concrete, except that MF12 Soffit Cleats are not required.



6

- If strap is used, it is important to pre-bend it to ensure a snug fit around the Gyproframe MF7C. If the connection occurs on a steeply curving Gyproframe MF7C section, consider forming the connection 'stirrup' separately from the hanger to enable a vertical drop. See **Figure 3**.

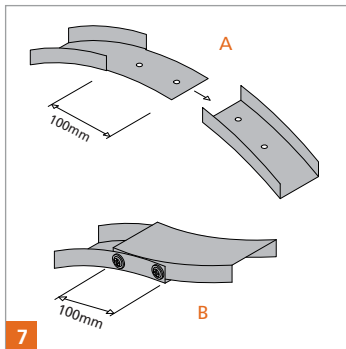

7

- Join lengths of Gyproframe MF7C by cutting back the flanges on one section and overlapping by 100mm. Secure using two Gyproc Wafer Head Jack-Point Drywall Screws (see **Figure 7 option A above**). At changes in the direction of curvature install two fixings through each flange (see **Figure 7 option B above**).

! A hanger is required at Gyproframe MF7C junction positions.



8

- Fix Gyproframe MF5 Ceiling Section to the underside of the Gyproframe MF7C at 300mm centres using two Gyproc Wafer Head Jack-Point Drywall Screws. See **Figures 9 & 10**.

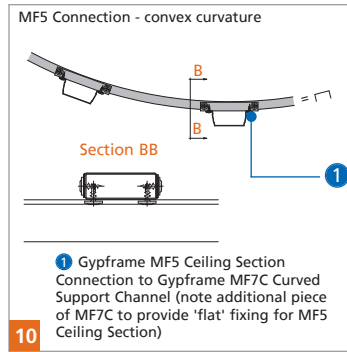
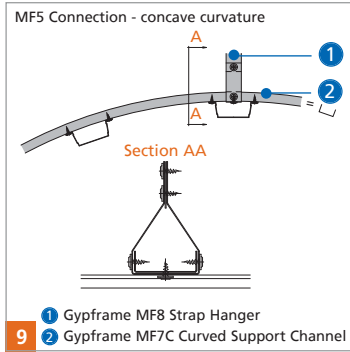

- If the Gypframe MF7C is installed with legs down, a small section of Gypframe MF7C is fixed to bridge the flanges to provide a flat, positive fixing for the Gypframe MF5 positions. Secure the small Gypframe MF7C sections with two Gyproc Wafer Head Jack-Point Drywall Screws through each flange. See Figure 10.



Board fixing - single layer

- Select the board option to give the curvature required (see **Table 1**).
- Fix boards with their long edges at right angles to the Gypframe MF5 Ceiling Sections. Stagger board joints and avoid joints occurring on the apex of a convex curve otherwise problems may be encountered when finishing.
- Insert fixings no closer than 10mm from bound board edges and 13mm from cut edges.

- Insert Gyproc Drywall Screws at 230mm centres to all supports in the field of the board and at 150mm centres at board ends.

NB Select screw lengths to give nominal 10mm penetration into the steel.

Board fixing - double layer

- Select the board option to give the curvature required (see **Table 1**).
- Fix the inner layer boards as for 'Board fixing - single layer', previously.
- Fix outer layer boards at 230mm centres to all supports in the field of the board and 150mm centres at board ends, with joints staggered in relation to the first layer. Avoid board joints occurring in the outer layer of boards on the apex of the curve.

Junction details

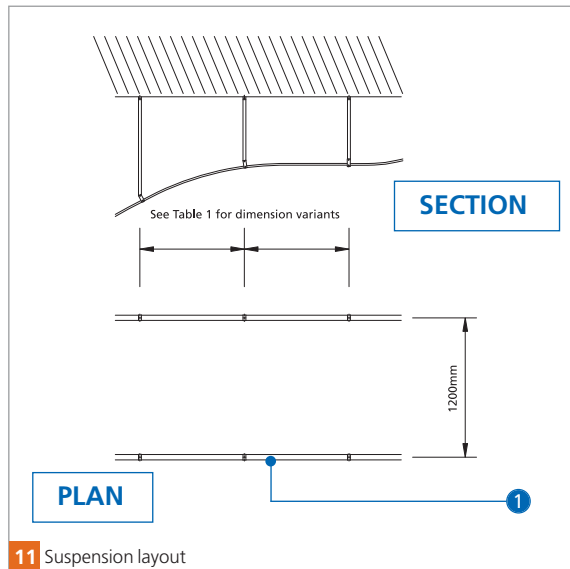

NB Select screw lengths to give nominal 10mm penetration into the steel.

NB Board fixing Arteco Gyptone and Arteco Rigitone refer to British Gypsum Ceilings Installation Guide. (www.british-gypsum.com)

NB Whilst good finishing can be achieved using normal jointing techniques, a plaster skim finish may be considered (with the exception of Gyptone boards), particularly where there are a number of butt end joints to the curve

1 Gypframe MF7C Curved Support Channel

Concealed grid ceiling lining system

GypLyner UNIVERSAL ceiling is a general purpose ceiling lining system suitable for most internal applications. It is used in all types of buildings, from residential properties to large commercial developments, and is equally suited to both new-build and refurbishment. The system is compatible with, and uses common components of, GypLyner UNIVERSAL wall lining and GypLyner ENCASE steel encasement systems.



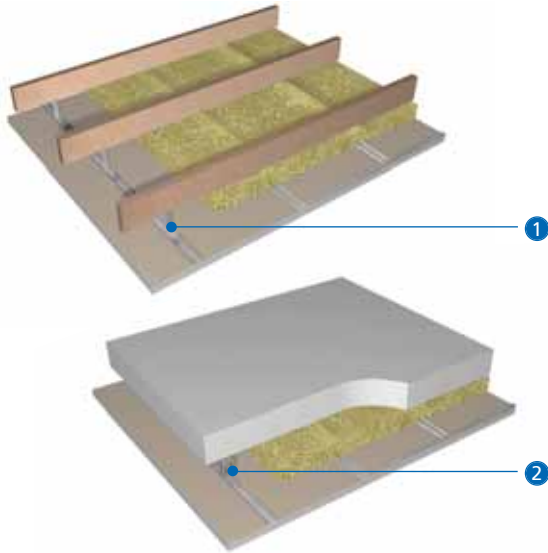

- 1 Gypframe GL1 Lining Channel + Gypframe GL5 or GL6 Timber Connector
- 2 Gypframe GL1 Lining Channel + Gypframe GL2, GL9 or GL12 Bracket

Key facts

- General purpose and versatile ceiling lining
- Suitable for concrete soffits or timber joists
- Seamless lining surface
- Ceiling void accommodates small service routings
- Stand-off can be adjusted
- Commonality of ceiling and wall lining components





Components

Gyproc and Glasroc board products

			Take-off quantities ¹
	Gyproc WallBoard^{2,3} Thickness 12.5, 15mm Width 900, 1200mm		100m ²
	Gyproc SoundBloc² Thickness 12.5, 15mm Width 1200mm		100m ²
	Gyproc FireLine^{2,3} Thickness 12.5, 15mm Width 900, 1200mm		100m ²
	Gyproc Plank Thickness 19mm Width 600mm		100m ²
	Glasroc MultiBoard Thickness 12.5mm Width 1200mm		100m ²



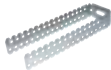

¹ Quantities are for 100m² of regular shaped rectangular ceiling. Quantities are approximate for a single layer installation with Gyproc GL1 Lining Channels at 450mm centres. Quantities are for guidance only, no allowance has been made for waste. Refer to section 11 – Quantity take-off details.

Gypframe metal products

			Take-off quantities ¹
	Gypframe GL1 Lining Channel Length 2400, 2700, 3000, 3600mm		230m
	Gypframe GL2 Bracket For fixing to concrete or masonry structure. Length 195mm flat (max 75mm stand-off from structure)		240
	Gypframe GL9 Bracket Length 295mm flat (max 125mm stand-off from structure)		240
	Gypframe GL12 Bracket Length 395mm flat (max 175mm stand-off from structure)		240
	Gypframe GL3 Channel Connector For joining GL1 Lining Channels.		93
	Gypframe GL5 Timber Connector Maximum 35mm drop. Length 70mm		240

² Moisture resistant boards are specified in intermittent wet use areas e.g. shower cubicles.

³ Also available in DUPLEX grades where vapour control is required.





Gypframe metal products		Take-off quantities [†]
	Gypframe GL6 Timber Connector Maximum 120mm drop. Length 170mm	240
	Gypframe GL8 Track Length 3600mm	Subject to ceiling perimeter
Fixing and finishing products		
	Gyproc Proflex Access Panels For access to the plenum for maintenance purposes.	As required
	Gyproc Wafer Head Drywall Screws For metal-to-metal fixing up to 0.79mm thick.	500

Fixing and finishing products		Take-off quantities [†]
	Gyproc Drywall Timber Screws For fixing timber connectors to timber supports.	2 per connector
	Gypframe GL11 GypLyner Anchors For fixing GL2 or GL9 Brackets to concrete / masonry.	1 per bracket (if specified)
	Gyproc Drywall Screws For fixing boards to stud framing up to 0.79mm thick.	1800
	Gyproc Sealant Sealing air paths for optimum sound insulation.	1 cartridge per 35m based on 6-10mm bead
	Gyproc jointing materials For a seamless finish.	As required

Components

Fixing and finishing products

Take-off quantities[†]

	<p>Thistle Multi-Finish or Thistle Board Finish To provide a plaster skim finish.</p>	<p>10m² per 25kg bag</p>
	<p>Thistle Spray Finish Gypsum finish plaster for spray or hand application.</p>	<p>11m² per 25kg bag</p>
	<p>Isover General Purpose Roll For providing acoustic / thermal insulation.</p>	<p>As required</p>
	<p>or Isover APR 1200 For enhanced acoustic performance.</p>	<p>As required</p>

[†] Quantities are for 100m² of regular shaped rectangular ceiling. Quantities are approximate for a single layer installation with Gypframe GL1 Lining Channels at 450mm centres. Quantities are for guidance only, no allowance has been made for waste. Refer to section 11 – Quantity take-off details.

Construction tips

- Estimated construction time 3m² / man hour (single layer ceiling) or 2m² - 2.5m² / man hour (double layer ceiling) - ready for finishing
- For concrete soffits allow for a stand-off of 25mm-75mm plus lining thickness using Gypframe GL2 Brackets, 25mm-125mm plus lining thickness using Gypframe GL9 Brackets, and 25mm-175mm plus lining thickness using Gypframe GL12 Brackets
- For timber joists using Gypframe GL5 or GL6 Timber Connectors, allow for a maximum cavity depth of 35mm and 120mm respectively (measured from the bottom of the joists to the underside of the lining)
- Gypframe GL11 GypLyner Anchors are recommended for fixing brackets to solid concrete and masonry
- Seal all gaps at the perimeter of the ceiling and any small air paths with Gyproc Sealant to maintain airtightness and optimum sound insulation
- Recommended board size is 900mm x 1800mm - if longer boards are specified, lift and hold against the ceiling using a Gyproc Projack or Gyproc Board Lift
- To reduce the risk of interstitial condensation install a vapour control layer using DUPLEX grade board
- Predetermine the position of fixtures and fittings with supplementary framing, and use Gyproc Proflex Access Panels at key access points

Installation - concrete soffit

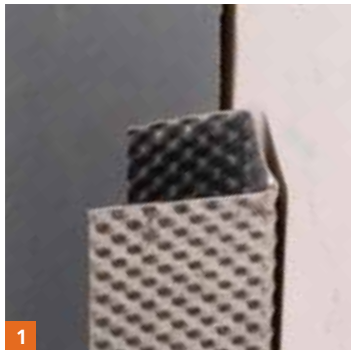

1

- Determine the required ceiling level and mark the position of Gypframe GL8 Track.
- Fix Gypframe GL8 Track with the longer leg at the bottom, at 600mm centres using suitable fixings.
- Mark lines on the soffit to determine the GypLyner bracket positions. Position the lines at 450mm intervals (12.5mm linings) or 600mm intervals (15mm linings).



2

- Fix brackets at 1200mm maximum centres. Position each bracket, fold down one leg and fix through bracket slot to the soffit using a Gypframe GL11 GypLyner Anchor. Mark protruding leg of each bracket to indicate the fixing level of the Gypframe GL1 Lining Channel.
- NB** Select Gypframe GL2 Bracket for stand-offs between 25mm and 75mm; Gypframe GL9 Bracket for stand-offs between 25mm and 125mm; or Gypframe GL12 Bracket for stand-offs between 25mm and 175mm.



3

- Locate Gypframe GL1 Lining Channel into the perimeter track.



- Position the channel, bend down the other leg of each bracket in turn and screw-fix each leg to the channel using Gyproc Wafer Head Drywall Screws.

NB Ensure that the channel is level before fixing.



- Bend back the protruding leg of each bracket to sit back from the channel face.



- Extend channel sections, where required, by engaging channel ends over a Gyproframe GL3 Channel Connector.

Fixtures

- Install any additional channel or supplementary framing as required to support fixtures and fittings.



Board fixing

- Screw-fix board to supports with long edges at right angles to the framing.
- Lightly butt board ends and insert fixings no closer than 10mm from bound edges and 13mm from cut edges. Stagger end joints.
- Insert Gyproc Drywall Screws at 230mm maximum centres in the field of the boards, and 150mm maximum centres at board ends.

- For double layer linings stagger board joints in the second layer relative to the first.

NB Select Gyproc Drywall Screws to provide a nominal 10mm penetration into the framing (dependent on board thickness).

Installation - timber joists



- Determine the required ceiling level, mark and fix Gypframe GL8 Track at perimeter as for concrete soffits.
- Mark lines beneath the joists to determine the timber connector fixing positions. Position lines at 450mm intervals (12.5mm linings) or 600mm intervals (15mm linings).

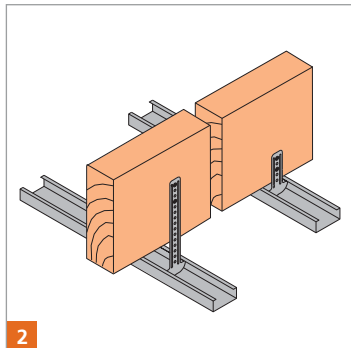

- Fix timber connectors at 1200mm maximum centres for single layer plasterboard specifications and maximum 600mm centres for double layer. Fix each timber connector to the side of a joist using two Gyproc Drywall Timber Screws.

NB Allow one hole between fixings for Gypframe GL5 Timber Connector; two holes between fixings for Gypframe GL6 Timber Connector. Align accurately since the connectors cannot be adjusted once fixed.



- Engage one side of the Gypframe GL1 Lining Channel into a row of timber connectors and twist into position.
- Push the channel to locate into the perimeter track.
- Extend channel sections, where required, by engaging channel ends over a Gypframe GL3 Channel Timber Connector (see **Construction detail 6**).

Board fixing

- Fix board to supports as for concrete soffits but ensure that board edge joints do not coincide with the position of timber connectors.

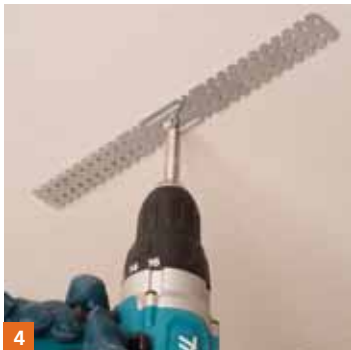

Existing ceiling

- If the existing ceiling is to be retained, Gypframe GL2, GL9 or GL12 Brackets are fixed to joists through the retained ceiling with suitable fixings and washers. Gypframe GL1 Lining Channels and boards are fixed to form the new ceiling.

Construction details

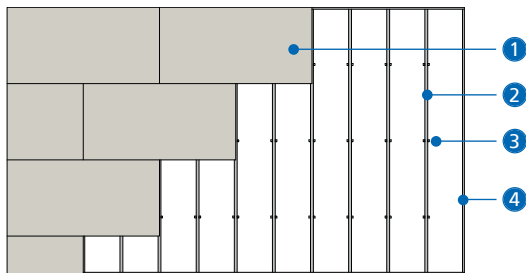

5 Reflected ceiling plan for concrete soffit - single layer 15mm Gyproc plasterboard with channels at 600mm maximum centres (or 12.5mm Gyproc plasterboard with channels at 450mm maximum centres)

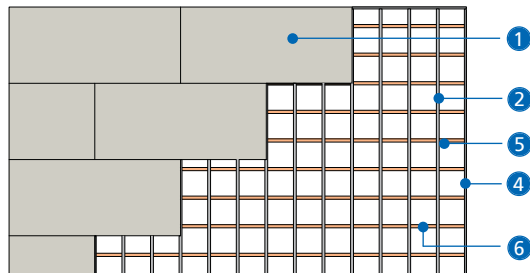

6 Reflected ceiling plan for timber joist floor - single layer 12.5mm Gyproc plasterboard with channels at 450mm maximum centres (or 15mm Gyproc plasterboard with channels at 600mm maximum centres)

- | | |
|-------------------------------------|--|
| 1 Gyproc plasterboard | 4 Gypframe GL8 Track |
| 2 Gypframe GL1 Lining Channel | 5 Gypframe GL5 or GL6 Timber Connector |
| 3 Gypframe GL2, GL9 or GL12 Bracket | 6 Timber joist floor |

Suspended grid ceiling system

Casoline GRID is a lightweight ceiling system available in concealed or exposed grid options. It presents an attractive pre-finished white ceiling and a range of decorative effects are possible by selecting the desired tile/board edge profile and finish. Pre-finished tile options include smooth, textured, patterned or perforated effects.

For further installation guidance on specialist systems, please refer to the British Gypsum website www.british-gypsum.com

Alternatively, contact the British Gypsum Drywall Academy Advice Centre on 0800 800 1991.



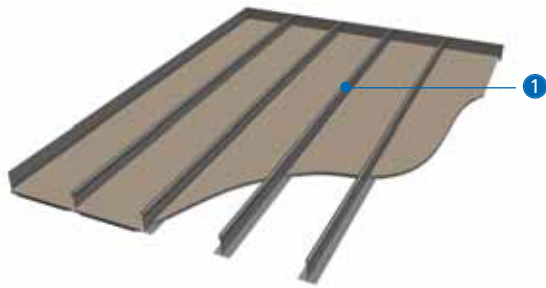

1 Artec CasoLine CLT15P01 Main T

Key facts

- Concealed or exposed grid options
- Attractive pre-finished white surface
- Wide range of ceiling tiles giving smooth, textured, patterned or perforated effects
- Provides sound attenuation and absorption
- Electrical and other services accommodated in plenum

Timber joist

Timber joist ceilings and separating / compartment floors

Ceilings to timber joist floors are an established form of ceiling construction, widely used in both new housing and refurbishment. Separating / compartment floors are often specified as fire and sound resisting floors in residential units, such as flats and apartments, to meet the requirements of national Building Regulations.

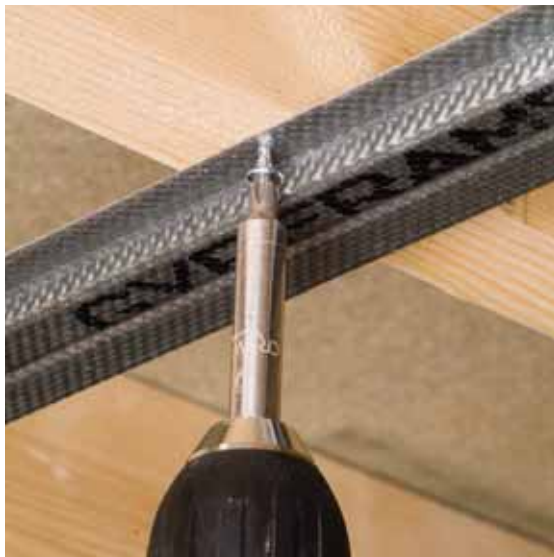

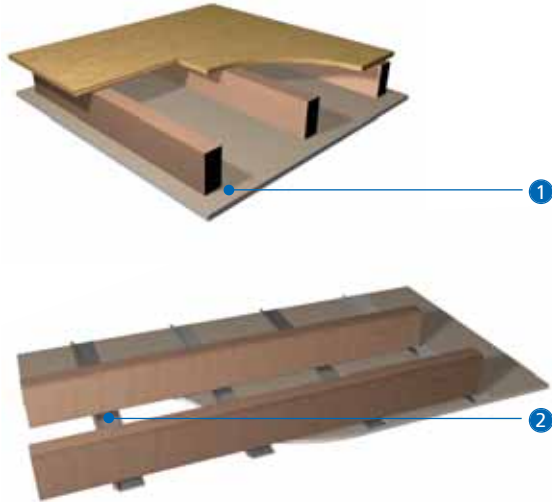

- 1 Gyproc plasterboard - direct fix with Gyproc Drywall Timber Screw
- 2 Gypframe RB1 Resilient Bar or Gypframe RB2 SureFix Bar - indirect fix

Key facts



- Traditional and established method
- Versatile
- Use of Gyproc Drywall Timber Screws minimises fixing defects
- Gypframe RB1 Resilient Bar and Gypframe RB2 SureFix Bar provide enhanced acoustic performance and eliminate nail-popping
- Can achieve high performance levels
- Quick and easy to install

Components**Gyproc board products**

			Take-off quantities ¹
	Gyproc WallBoard^{2,3}	Thickness 12.5, 15mm Width 900, 1200mm	100m ²
	Gyproc FireLine^{2,3}	Thickness 12.5, 15mm Width 900, 1200mm	100m ²
	Gyproc SoundBloc³	Thickness 12.5, 15mm Width 1200mm	100m ²
	Gyproc Plank	Thickness 19mm Width 600mm	100m ²
	Gyproc HandiBoard³	Thickness 9.5, 12.5mm Width 600, 900mm	100m ²

¹ Quantities are for 100m² of regular shaped rectangular ceiling. Quantities are approximate for a single layer installation with Gypframe RB1 Resilient Bar or Gypframe RB2 SureFix Bar component at 450mm centres when specified. Quantities are for guidance only, no allowance has been made for waste.

Glasroc board products

			Take-off quantities ¹
	Glasroc MultiBoard	Thickness 6, 10, 12.5mm Width 1200mm	100m ²
	Glasroc FireCase s	Thickness 15mm Width 600, 1200mm	100m ²



Gypframe metal products

	Gypframe RB1 Resilient Bar	Length 3000mm	250 m
	Gypframe RB2 SureFix Bar	Length 3000mm	250 m

² Moisture resistant boards are specified in intermittent wet use areas e.g. shower cubicles.

³ Also available in DUPLEX grades where vapour control is required.

Fixing and finishing products		Take-off quantities ¹
	Gyproc Drywall Timber Screws or Glasroc FireCase Screws For a positive direct fix of boards to timber joists.	1560
	Gyproc Drywall Screws For fixing ceiling lining boards to Gyproframe SureFix Bars or Resilient Bars.	1800
	Gyproc Sealant Sealing air paths for optimum sound insulation.	1 cartridge per 35m based on 6-10mm bead
	Gyproc jointing materials For seamless jointing.	As required
	Thistle Multi-Finish or Thistle Board Finish To provide a plaster skim finish.	10m ² per bag

Fixing and finishing products		Take-off quantities ¹
	Thistle Spray Finish Gypsum finish plaster for spray or hand application.	11m ² per bag
	Isover APR 1200 For enhanced acoustic performance. 25mm, 50mm and 100mm.	As required
	Isover General Purpose Roll For providing acoustic / thermal insulation.	As required
	Isover Sound Deadening Floor Slab – Rigid Grade	As required
	Stone mineral wool For providing fire performance.	As required

Construction tips

- Estimated construction time 15 - 20m² / man hour (single layer ceiling - boarding only) or 8 - 10m² / man hour (double layer ceiling - boarding only) ready for finishing
- To minimise the risk of cracking at plasterboard joints, use seasoned timber with a moisture content not exceeding that recommended in *BS5268: Part 2*. Even timber conforming to the standard will shrink on drying and fixing defects could occur if plasterboard is fixed directly using nails
- To minimise the risk of fixing defects occurring, use Gyproc Drywall Timber Screws for fixing into standard softwood, super-dried timber (approx. 12% moisture content) and engineered I beams. Fix boards tight to accurately spaced, aligned and levelled framing. Alternatively, use Gypframe RB2 SureFix Bar which eliminates nail-popping
- Select the right length of fixing (nominal entry into timber of 25mm, nominal entry into Gypframe RB1 Resilient Bar and RB2 SureFix Bar metal of 10mm)
- Ensure that the dimensions of timber supports are sufficient to allow positive fixing of plasterboards. Bearing surface of existing framing can be increased by fixing timber battens
- Install cavity barriers where specified
- Airtightness is essential for optimum sound insulation. While most junctions can be sealed with standard jointing materials, gaps at the perimeter of the ceiling, and other small airpaths, can be sealed using Gyproc Sealant

Construction tips (cont'd)

- Consider fixing DUPLEX grade board as the face layer where a vapour control layer is required
- Consider fixing Gypframe RB1 Resilient Bars to partially isolate linings from the timber framing to provide improved acoustic performance
- The designer should ensure that the floor construction is suitable to support any imposed loads. For construction advice please refer to the UK Timber Frame Association (UKTFA), website: www.timber-frame.org
- Consider the requirements for timber noggings to support board edges (see **Table 1 – Requirements for timber noggings**)
- Electrical and other small service runs can be routed within the floor cavity
- Minimise the number of service penetrations. Where these occur, they must be adequately fire-stopped by the appropriate contractor
- Fixtures should be made into joists, or to supplementary timber

Table 1 - Provision of timber noggings within traditional softwood timber floors¹

Board thickness	Maximum joist centres	
	with noggings mm	without noggings mm
6mm Glasroc MultiBoard	450	400
10mm Glasroc MultiBoard	600	450
12.5mm Gyproc plasterboard / Glasroc MultiBoard	600	450
15mm & 19mm Gyproc plasterboard	600	600
Gyproc ThermaLine laminates	600	450

¹ To be read in conjunction with Timber noggings within timber floors.

NB For engineered joists, please consult joist manufacturer / supplier for specific information.

Timber noggings within traditional softwood timber floors (direct fix applications)

Suitable timber noggings, typically 38mm x 38mm or 50mm x 50mm, may be required between joists and at the ceiling perimeter to support the edges / ends of the board. The provision of noggings depends on several factors; the thickness of board, spacing of timber joists and any technical performance requirements, e.g. vapour resistance and fire resistance performance. Table 1 provides information on the general requirement of noggings. However, reference must also be made to the relevant technical performance tables within the **WHITE BOOK** to establish the need for noggings in fire-rated situations. Furthermore, timber noggings should always be incorporated when fixing boards offering a vapour control layer, irrespective of joist spacing, e.g. **DUPLEX** grade Gyproc plasterboard and thermal laminates providing vapour control. Timber noggings are always required around the ceiling perimeter, except when using 15mm Gyproc WallBoard and 19mm Gyproc Plank in non fire-rated situations. In multi-layer plasterboard ceilings, the provision for noggings relates to the outer layer board only (unless otherwise stated).

Installation - direct fix plasterboard ceiling



Direct fix plasterboard ceiling

- Install boards to ceilings, prior to lining walls and partitions, with the long edges at 90° to the joists. Locate cut ends over a joist or timber noggings support.
- Provide timber noggings (where required) between joists and at perimeter to support board edges.

NB The provision of noggings, normally 38mm x 38mm, depends on the thickness of boards used, the spacing of timber joists and performance criteria (see **Table 1**).

Single layer linings

- Fix boards to timber supports using Gyproc Drywall Timber Screws. The former provide a superior fixing and will minimise any risk of fixing defects occurring.
- Where screws are used, install at 230mm centres.

- Lightly butt boards (maximum separation of 3mm), inserting fixings not closer than 10mm from bound edges and 13mm from cut edges.
- Position cut edges to internal angles and remove the paper burr using fine sand paper.
- Stagger all board end joints.

Refer to **Section 2, 'General Site Considerations - Fixing to timber supports'**, for recommendations on fixing tolerances, increasing the bearing surface of 35mm trussed rafters, and length of screw-fixings required.

NB If fixing 15mm Glasroc FireCase s use 60mm Glasroc FireCase Screws and locate at 150mm centres. In specifications using Glasroc MultiBoard strips in the cavity, fix to the side of joists at 300mm centres (top and bottom).

Double layer linings

- Mark the position of joists and noggings at the perimeter prior to installing first layer boards. After first layer boards have been installed, transfer their dimensions to the lining and mark lines to indicate the position of timber supports.
- Install second layer boards with edges/ends against the centre line of supports with all joints staggered in relation to the first layer.

Installation - indirect fix plasterboard ceiling

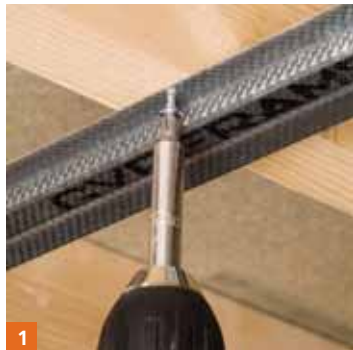

Indirect fix to Gypframe RB2 SureFix Bars

- Position the bar at maximum 600mm centres for single layer 15mm thick boards and at maximum 450mm centres for single layer 12.5mm.
- Fix Gypframe RB2 SureFix Bar through the single fixing flange to underside of joists using 36mm Gyproc Drywall Screws. Run Gypframe RB2 SureFix Bars at 90° to joists.

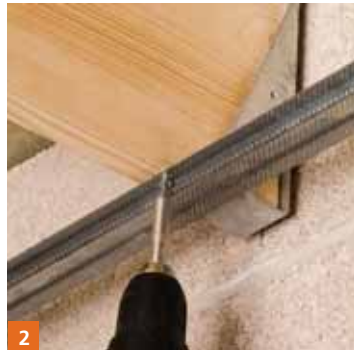

- Fix the first and last rows of Gypframe RB2 SureFix Bar as close to the perimeter wall as possible.

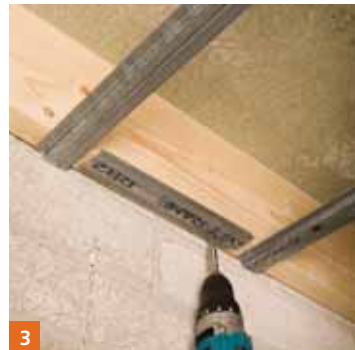

- Fix noggings of Gypframe RB2 SureFix Bar to remaining perimeters i.e. those perimeters parallel to the joists.

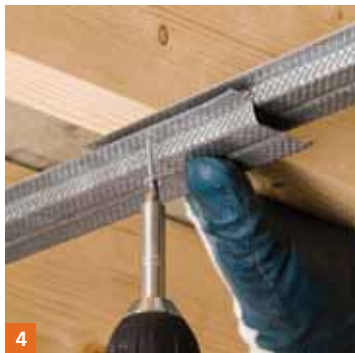

- If the bars are not long enough to span the ceiling, join by nesting together under a joist and a screw through both flanges.



Board fixing

- Fix board at 90° to Gypframe RB2 SureFix Bar with end joints staggered. Locate screws at 230mm centres in the field of the board and 150mm centres at board ends. Insert screws no closer than 10mm from bound board edges and 13mm from cut edges.

NB For a single layer of 12.5mm board and a single layer of 15mm board use 25mm Gyproc Drywall Screws. Take care to ensure the screw-fixing through the plasterboard is **not** driven into the joist.

- If Gyproc Plank is used as an under layer, insert 32mm Gyproc Drywall Screws and 42mm when over boarding with 12.5mm board. Lightly butt all board edges and, in multiple layer applications, position Gypframe RB2 SureFix Bars at 450mm maximum centres with joints between layers staggered.

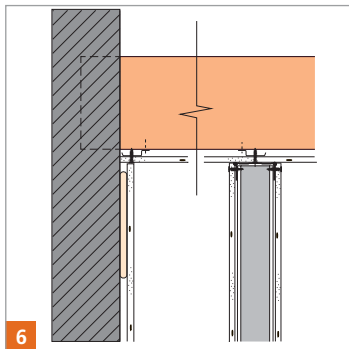

Partition fixing

- If GypWall RAPID or a similar partition type is to be installed to the underside of the ceiling, provision should be made to fix the head channel of the partition. If the partition is at 90° to the Gypframe RB2 SureFix Bar, connection through to it can be made using an appropriate length Gyproc Drywall Screw. If the partition is parallel to the Gypframe RB2 SureFix Bar, an extra length of section should be installed in the line of the partition.

Indirect fix to Gypframe RB1

Resilient Bars

- The procedure is similar to that for Gypframe RB2 SureFix Bars.

Ceiling plan – direct fix to timber joist

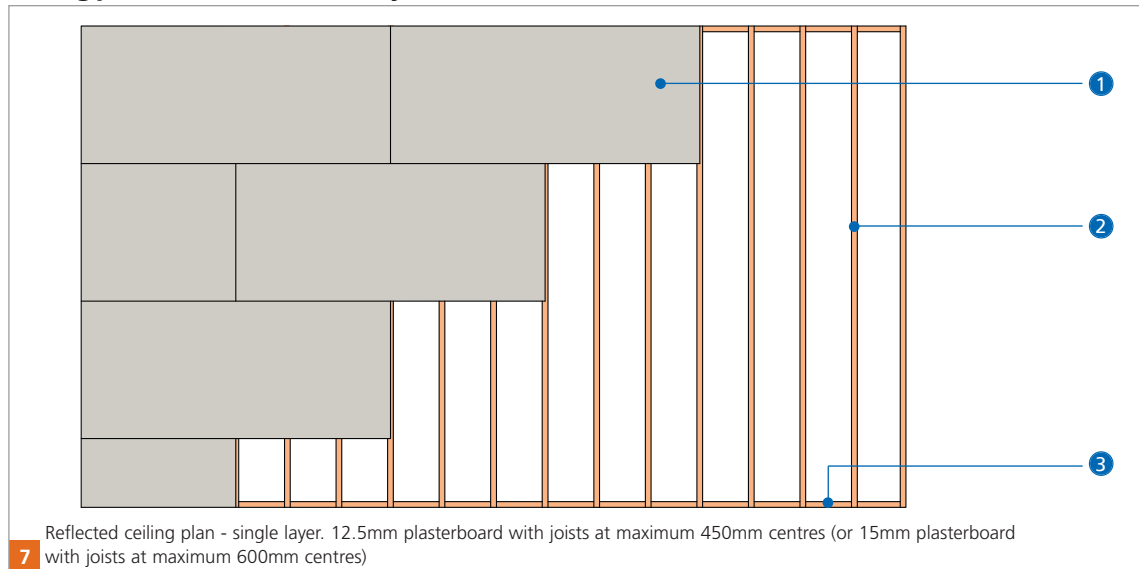

- 1 Gyproc plasterboard
- 2 Timber joist

- 3 Timber noggings to provide support at the perimeter

Ceiling plan – direct fix to timber joist

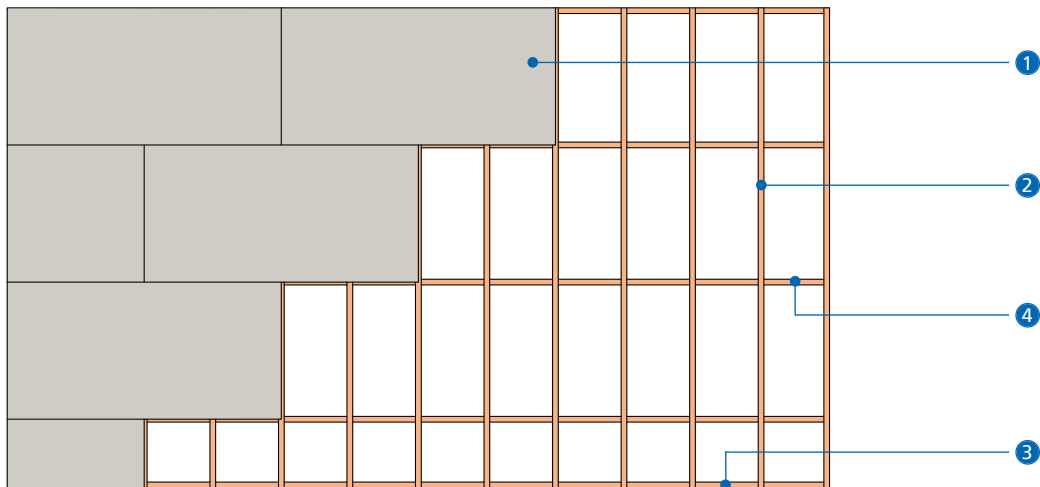

8 Reflected ceiling plan - single layer. 12.5mm plasterboard with joists at maximum 600mm centres

- 1** Gyproc plasterboard
- 2** Timber joist
- 3** Timber noggings to provide support at the perimeter
- 4** Timber noggings to support board edges

Ceiling plan – direct fix to timber joist

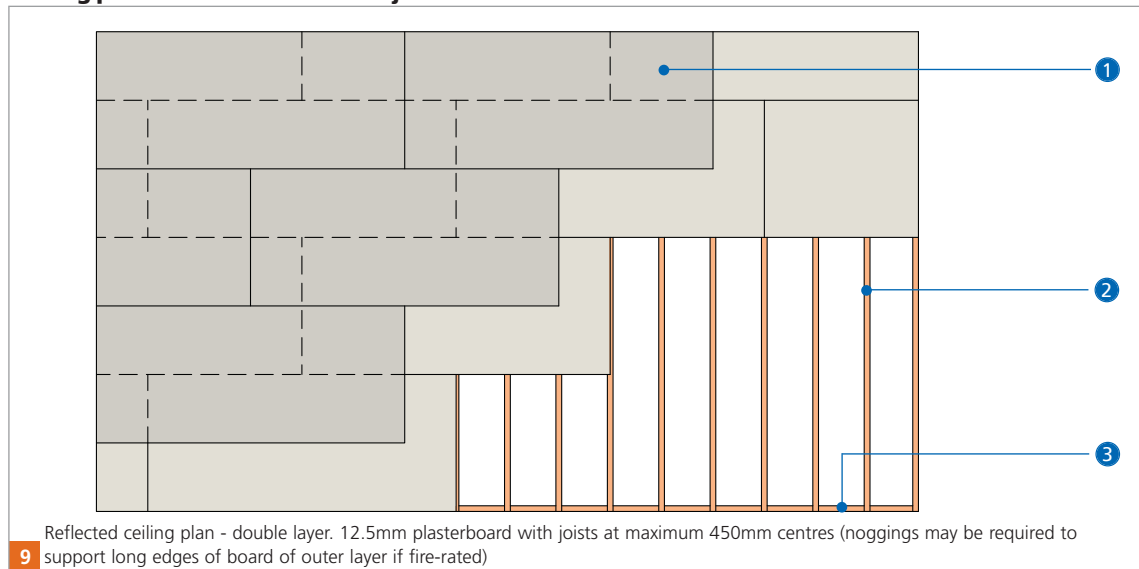

- 1 Gyproc plasterboard
- 2 Timber joist
- 3 Noggings to provide support at the perimeter

Ceiling plan – direct fix to timber joist

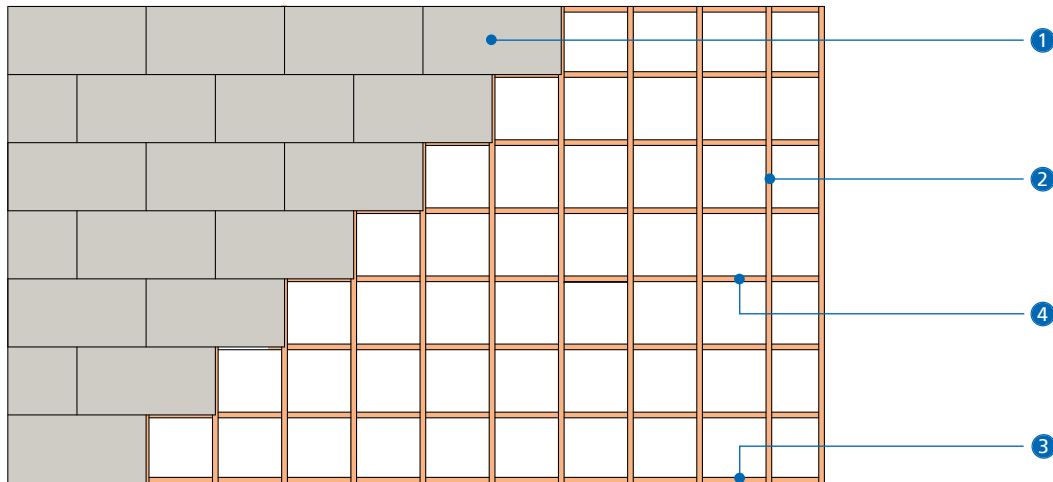

NB Noggings not required when joists at 406mm centre.

10 Reflected ceiling plan - single layer. 12.5mm Gyproc HandyBoard with joists at maximum 610mm centres

- ① Gyproc HandyBoard
- ② Timber joist
- ③ Noggings to provide support at the perimeter
- ④ Noggings to support board edges

Sound insulating floor system

GypFloor SILENT is specified in residential conversion or improvement work to upgrade an existing timber joist floor. It is also used in new-build to meet the acoustic requirements of national Building Regulations to reduce sound transmission through upper floors. It should be used in conjunction with an appropriate ceiling lining.



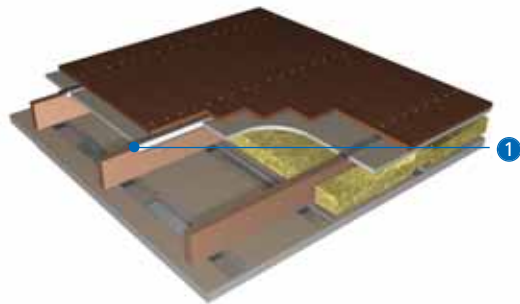

1 Gypframe SIF1 Floor Channel, Gypframe SIF2 Floor Channel or Gypframe SIF4 Floor Channel.

Key facts

- Dramatically improves airborne and impact sound insulation of existing timber joist floors
- Minimal increase in floor depth
- Used in conversion work and refurbishment to meet acoustic regulations
- Resilient interface between channel and floor joist

Components

Gyproc and Glasroc products

			Take-off quantities ¹
	Gyproc WallBoard^{2,3}		100m ² per layer
Thickness	12.5mm		
Width	1200mm		
	Gyproc SoundBloc²		100m ² per layer
Thickness	12.5, 15mm		
Width	1200mm		
	Gyproc FireLine²		100m ² per layer
Thickness	15mm		
Width	1200mm		
	Gyproc Plank		100m ² for floor 100m ² for ceiling if specified
Thickness	19mm		
Width	600mm		
	Glasroc MultiBoard		150m ² for Glasroc bridges if specified
Thickness	12.5mm		
Width	1200mm		

¹ Quantities are for 100m² of regular shaped rectangular floor, based on joists of 75mm or less at 400mm centres, with a chipboard walking surface and a double layer ceiling installation with Gypframe RB1 Resilient Bar component at 450mm centres. Quantities are approximate and for guidance only, no allowance has been made for waste. Can be used in conjunction with **CasoLine MF** ceiling or **GypLyner UNIVERSAL** ceiling sections.

Gypframe metal products

			Take-off quantities ¹
	Gypframe SIF1 Floor Channel		250m
Length	2000mm		
Width	127mm		
	Gypframe SIF2 Floor Channel		as required
Length	2000mm		
Width	85mm		
	Gypframe SIF4 Floor Channel		250m
Length	2000mm		
Width	140mm		
	Gypframe RB1 Resilient Bar		250m
Length	3000mm		

² Moisture resistant boards are specified in intermittent wet use areas e.g. shower cubicles.

³ Also available in **DUPLEX** grades where vapour control is required.

Fixing and finishing products	Take-off quantities ¹
 <p>Gypframe SIF5 Floor Screws For fixing floorboards through Gyproc Plank into the Gypframe floor channel flange.</p>	1250
 <p>Gyproc Drywall Screws For fixing boards to Gypframe RB1 Resilient Bars, and Gypframe RB1 Resilient Bars to timber joists.</p>	1800 per layer
 <p>Gyproc Sealant For sealing air paths to achieve optimum sound insulation.</p>	1 cartridge per 35m based on a 6 - 10m bead
 <p>Gyproc jointing materials For seamless jointing.</p>	as required

Fixing and finishing products	Take-off quantities ¹
 <p>Thistle Multi-Finish or Thistle Board Finish To provide a plaster skim finish.</p>	10m ² per 25kg bag
 <p>Thistle Spray Finish Gypsum finish plaster for spray or hand application.</p>	11m ² per 25kg bag
 <p>Isover General Purpose Roll For providing acoustic / thermal insulation.</p>	100m ²

Construction tips

- Estimated construction time 0.5m²/ man hour - ready for finishing
- The system will add approx. 7mm height to the finish floor level
- The finished surface of the applied ceiling will be 48mm from the underside of the joists (when Gypframe RB1 Resilient Bar, a layer of Gyproc Plank and 12.5mm Gyproc SoundBloc are applied)
- The system is primarily intended for traditional solid timber joist floors – intensity of distributed load of up to 5.0kN/m² and a concentrated load of 4.5kN/m²
- In refurbishment work check the level of existing joists is not misaligned – if so consider **GyLyner** systems or **CasoLine MF** suspended ceiling to the underside of the joists
- Ensure tops of joists are level to accommodate SIF floor channels
- Ascertain the correct Gypframe SIF Floor Channel to use - Joist width up to 63mm use Gypframe SIF1 Floor Channel, joist widths between 64 -75mm use Gypframe SIF4 Floor Channel and joists over 75mm use Gypframe SIF2 Floor Channel (2 per joist position unless adjacent to the wall)

Construction tips (cont'd)

- To maintain optimum sound insulation consider the following:
 - Ceilings should be fixed prior to drylining / plastering on walls. If this is not possible abut the ceiling against the wall surface
 - If an existing ceiling is being retained additional sound insulation will be required – contact British Gypsum for further guidance
 - Make suitable provision to minimise flanking sound in the surrounding structure
 - Seal the perimeter, including gaps between wall and floor linings with Gyproc Sealant
 - Glue joints of chipboard flooring
 - Gypframe SIF Floor Channel must not be mechanically fixed to the joists

Installation - Floor



Installation (standard) for joists 63mm or less

- Locate Gypframe SIF1 Floor Channel sections centrally over the joists, leaving a 6mm clearance gap at walls.
- Where joints in channel occur, butt the sections together.



2

- Where joists run close to the wall (30mm gap or less), locate Gypframe SIF2 Floor Channel in place of Gypframe SIF1 Floor Channel.



3

- Stop SIF channels either side of strutting or services which interrupt channel location.



4

- Where joists overlap, cut away the channel legs to allow channels to run through.



● Cut Gyproc Plank to a neat (not tight) fit between channels. Allow a 3mm gap between Gyproc Plank and channel sides.

NB Ensure that the vertical flanges of the channels do not impinge on the sides of the joists when the Gyproc Plank infills are installed.

NB To minimise waste cut Gyproc Plank across its length to create tiles which lie bound edge to bound edge.



● Lay flooring across the channels and screw-fix through the Gyproc Plank to the channel flange on one side only using a Gypframe SIF5 Floor Screw (see Figure 12).



Services

● Where water pipes or other services penetrate the floor, cut Gyproc Plank and flooring to allow a small clearance. Seal any gaps in order to minimise loss of acoustic performance, and suitably fire-stop (if required).

Installation - RB1 Ceiling



- Mark the underside of joists at 450mm centres to indicate the positioning of Gypframe RB1 Resilient Bars (centres will be 400mm for 2400mm long board).
- Fix Gypframe RB1 Resilient Bars through their flange to each joist using 36mm Gyproc Drywall Screws.
- If the resilient bars are not long enough to span the ceiling, join by nesting together under a joist and a screw through both flanges.

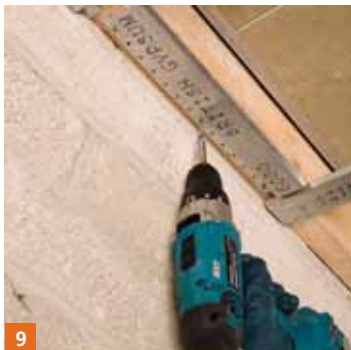

- Cut Gypframe RB1 Resilient Bar noggings to fit between the rows of bar at the ceiling perimeter and screw-fix to the joist.



- Lay Isover General Purpose Roll (100mm) between joists to rest on the resilient bars.
- Fix base layer board to the resilient bars using appropriate length Gyproc Drywall Screws with the long edge of boards at right angles to the resilient bars.
- Insert screws at 230mm maximum centres in the field of boards, and 150mm maximum centres at board ends.



- Fix face layer board through to all resilient bar supports using appropriate length Gyproc Drywall Screws. Insert screws no closer than 10mm from bound board edges and 13mm from cut edges. Stagger board joints in the second layer relative to the first (see **Junction details**).

NB Select length of fixing to provide a nominal 10mm penetration into the Gypframe RB1 Resilient Bar supports. Ensure no contact of screw with timber joists.

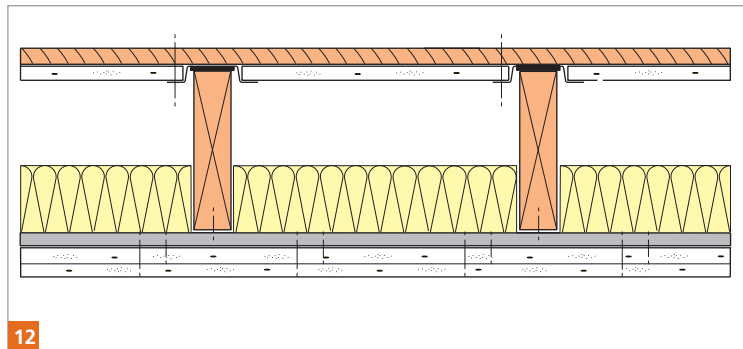

12

Typical section through floor

- Gypframe SIF1 Floor Channel - for joists up to 63mm wide
- Gypframe SIF4 Floor Channel - for joists 64 - 75mm wide

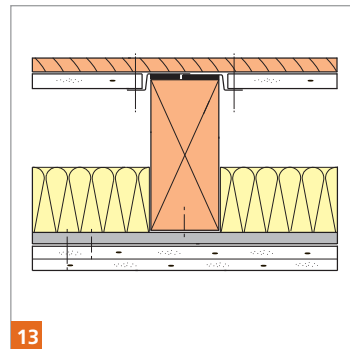

13

Installation for joists over 75mm

- As standard but use two Gypframe SIF2 Floor Channels per joist.
- Cut away the foam inlay on one channel to facilitate overlap, and leave a 2 - 3mm clearance gap between each channel and the side of the joist.

Junction details

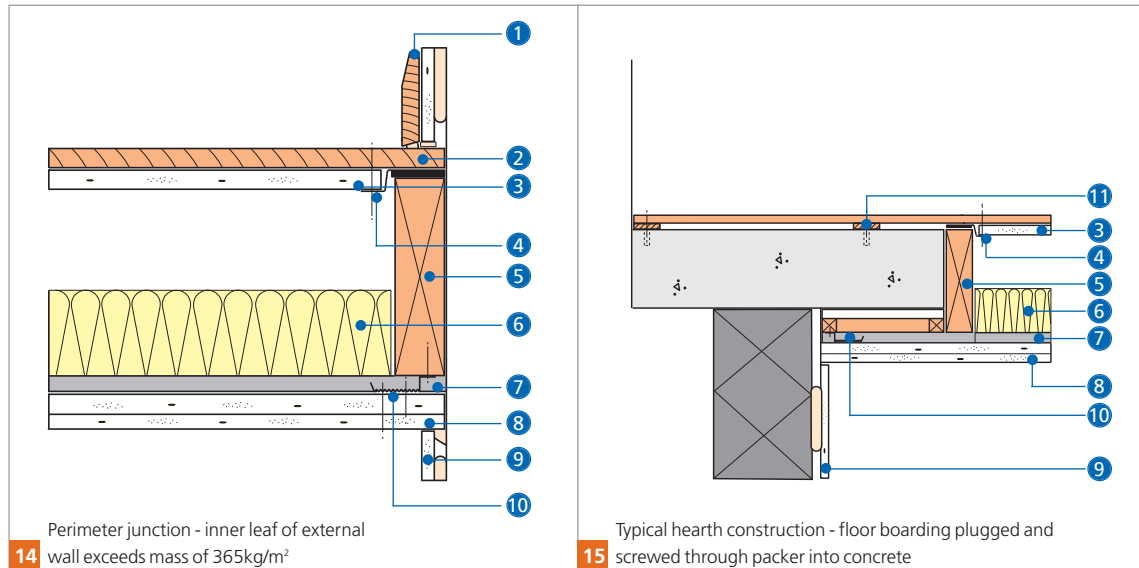

- 1 Skirting
- 2 Chipboard / softwood flooring
- 3 Gyproc Plank
- 4 Gyproframe SIF2 Floor Channel

- 5 Solid timber joist.
- 6 100mm Isover General Purpose Roll
- 7 Gyproframe RB1 Resilient Bars
- 8 Ceiling lining boards

- 9 Wall lining
- 10 Gyproframe RB1 Resilient Bar noggings
- 11 Packer

Junction details

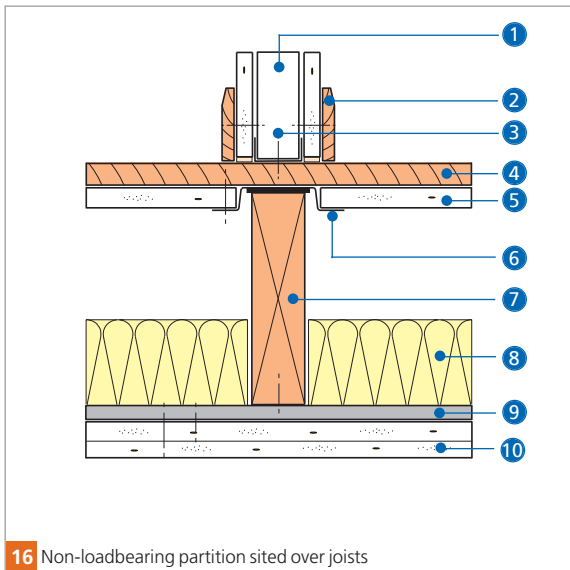

Siting of non-loadbearing partitions

- Where the partition is required to run parallel to the joists, but not directly over them, provide joist noggings at 600mm intervals.
- Cap the noggings with short lengths of Gypframe SIF1 Floor Channel under the line of the partition.

1 **GypWall** partition

2 Skirting

3 Fixing length selected to avoid reaching the Gypframe SIF1 Floor Channel

4 Chipboard / softwood flooring

5 Gyproc Plank

6 Gypframe SIF1 / SIF4 Floor Channel

7 Solid timber joist

8 100mm Isover General Purpose Roll

9 Gypframe RB1 Resilient Bars

10 Ceiling lining boards

Junction details - plan drawings

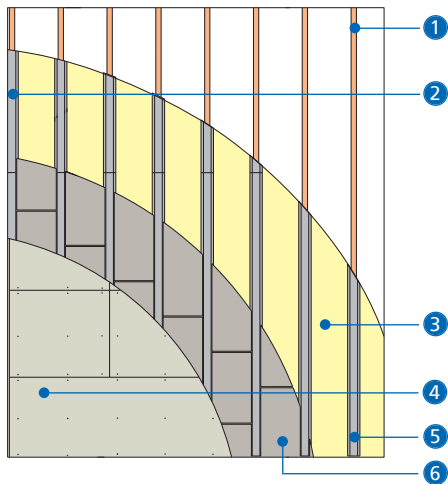

17 Cut-away floor plan (chipboard flooring)

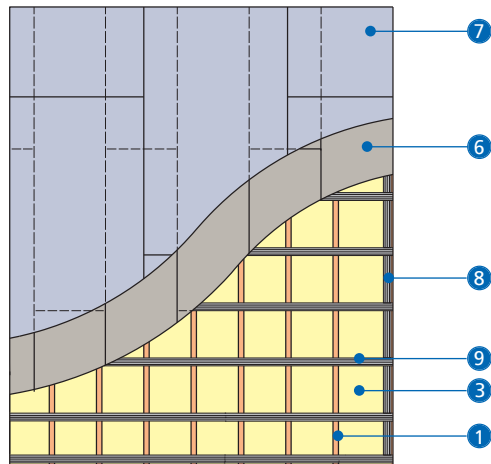

18 Reflected ceiling plan (12.5mm x 1200mm x 2700mm Gyproc SoundBloc over Gyproc Plank fixed to Gyproframe RB1 Resilient Bars)

- | | | |
|--|---|--|
| 1 Solid timber joists | 5 Gypframe SIF1 / SIF4 Floor Channel | 8 Gypframe RB1 Resilient Bar noggings at room perimeter |
| 2 Gypframe SIF2 Floor Channel | 6 Gyproc Plank | 9 Gypframe RB1 Resilient Bar |
| 3 Isover General Purpose Roll (100mm) | 7 Gyproc SoundBloc | |
| 4 Chipboard flooring | | |

Floating floor treatment for separating floors

GypFloor SB, incorporating Gypframe Steel Battens, is a unique floating floor system for use within residential separating floors. The system offers significant improvements in airborne and impact sound insulation on timber and concrete constructions to meet the requirements of national Building Regulations Approved Document E.



Timber floor

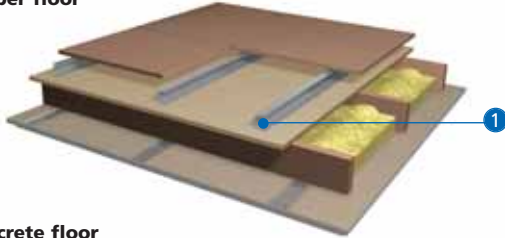

Concrete floor

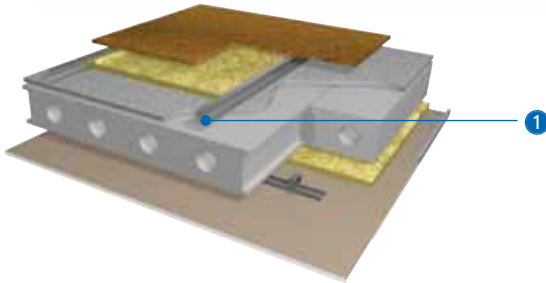



1 Gypframe 70 SB 65 Steel Batten or Gypframe 50 SB 65 Steel Batten. Gypframe SB4 Levelling Cradle and Gypframe SB5 Levelling Packer

Key facts

- GypFloor **sb** is incorporated within a range of British Gypsum separating floor systems approved by the SpecSure® system lifetime system warranty
- The system incorporates lightweight engineered Gypframe UltraSTEEL® components
- Gypframe cradles and packers provide option for levelling uneven sub-structures
- 50mm and 70mm battens provide two options for service requirements
- Galvanised Gypframe Steel Battens can be stored externally
- GypFloor **sb** offers a walking surface of superior stability and a solid platform upon which lightweight non-loadbearing partitions and ceramic tiling can be installed

Components

Gyproc board products

		Take-off quantities ¹
	Gyproc SoundBloc Thickness 12.5, 15mm Width 1200mm	100m ² per layer
	Gyproc FireLine² Thickness 12.5mm Width 1200mm	100m ² per layer
	Gyproc Plank Thickness 19mm Width 600mm	100m ² for floor if specified 100m ² for ceiling if specified



Gypframe metal products

		Take-off quantities ¹
	Gypframe 50 SB 65 Steel Batten For use with shallow batten system Length 1800mm Depth 50mm	295m
	Gypframe 70 SB 65 Steel Batten For use with deep batten system Length 1800mm Depth 70mm	295m
	Gypframe SB3 Flanking Strip To eliminate flanking sound transmission Length 10m roll Width 150mm	40m
	Gypframe SB4 Levelling Cradle For use on uneven masonry sub structure	540
	Gypframe SB5 Levelling Packer For use in SB4 levelling cradles on uneven masonry sub-structure.	540

¹ Quantities are for 100m² of regular shaped rectangular floor with a chipboard walking surface and a double layer ceiling installation with Gypframe RB1 Resilient Bar component at 450mm centres. Quantities are approximate and for guidance only, no allowance has been made for waste.

² Also available in DUPLEX grades where vapour control is required.

³ GypLyner UNIVERSAL ceiling components see 7 - GypLyner UNIVERSAL. For CasoLine MF ceiling components see 7 - CasoLine MF.

British Gypsum ceiling systems ³		Take-off quantities ⁷
	Gypframe RB1 Resilient Bar Length 3000mm	250m if specified
Fixing and finishing products		
	Gypframe SIF5 Floor Screws For fixing floorboards through Gyproc Plank into the Gypframe steel battens.	1250
	Glasroc FireCase Screws For fixing floorboards through Gyproc Plank into the Gypframe steel battens.	1250
	Gyproc Drywall Screws For fixing ceiling boards to Gypframe Resilient Bars.	1800

Fixing and finishing products		Take-off quantities ⁷
	Gyproc Sealant Sealing air paths for optimum sound insulation.	1 cartridge per 35m based on a 6-10mm bead
	Gyproc jointing materials For a seamless finish.	as required
	Thistle Multi-Finish or Thistle Board Finish To provide a plaster skim finish.	10m ² per 25kg bag
	Thistle Spray Finish Gypsum finish plaster for spray or hand application.	11m ² per 25kg bag
	Isover General Purpose Roll For providing acoustic / thermal insulation.	100m ²
	Isover APR 1200 For enhanced acoustic performance. 25mm and 50mm.	100m ²

Construction tips

- Allow a 50mm gap between the room perimeter and Gypframe Steel Battens
- Perpendicular battens are laid with a 25mm gap between sections
- Adjoining Gypframe Steel Battens are lightly abutted - no complicated fixing or nesting techniques required
- Gypframe Steel Battens can be fixed to the sub deck to aid installation, where required, and making them compatible with off site manufacturing of floor cassettes
- Fix Gypframe SB3 Flanking Strip to minimise sound transmission from walking surfaces into separating walls
- When laying battens around services, stop one batten 25mm short of the pipes or cables, then start the next batten 25mm after. Cutting holes in battens for services should be avoided

Installation

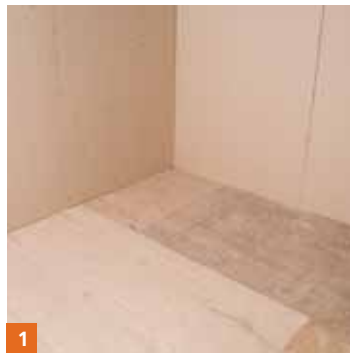

- Before starting work, ensure floor area is swept clear of loose material and debris. Additionally, to allow adhesion of flanking strip, ensure surrounding walls are free from dust and loose material.



2

- Position Gypframe SB3 Flanking Strip around the room perimeter against the lower part of the wall. Any excess strip can be cut away once the floor is laid.

NB Staple fixing Gypframe SB3 Flanking Strip to plasterboard lining is an easy method.

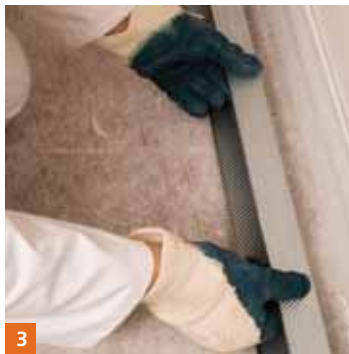

3

- Lay Gypframe Steel Battens around the room perimeter leaving a 50mm gap between the wall and the batten.

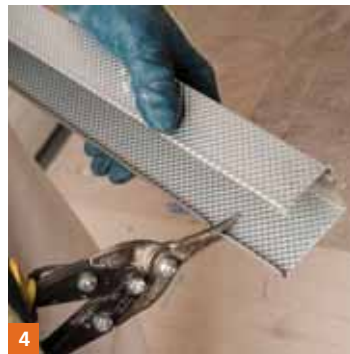

4

- Cut Gypframe Steel Battens with tin snips or a chopsaw.



- The design loadings for self contained dwelling units, as defined in *BS 6399: Part 1*, are: intensity of distributed load 1.5kN/m^2 concentrated load 1.4kN
- For these normal (domestic) loading requirements, position Gypframe Steel Battens at 400mm centres.

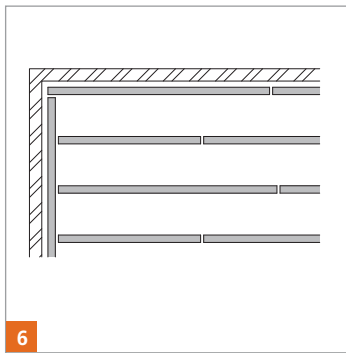

- A 25mm gap should be left between perpendicular sections. The battens should be staggered by a minimum of 600mm to avoid the occurrence of more than one joint under any one piece of flooring.



- When using the system on uneven sub-floors, Gypframe SB4 Levelling Cradles can be positioned under the sections.



- Gypframe levelling cradles should be positioned at 600mm centres when installing 50mm battens. For 70mm battens position cradles at 450mm centres.
- Gypframe SB5 Levelling Packers can be used inside the cradle, as required.

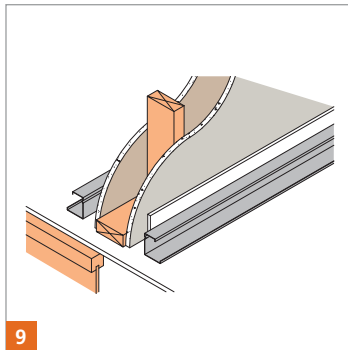

- Loadbearing partitions and separating walls should be erected directly onto the sub-floor. Non-loadbearing partitions, such as the **GypWall** range, can be erected on top of the **GypFloor SB** system. Provision should be made in the layout to allow one or two (depending on partition width) Gypframe Steel Battens beneath the partition to give support and a fixing ground.

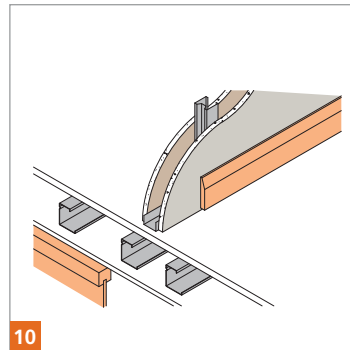

- To minimise the effect of any camber on concrete sub-floors, partitions can be mounted into the sub-floor, thus minimising the effect of the camber by dividing the floor area into individual rooms.

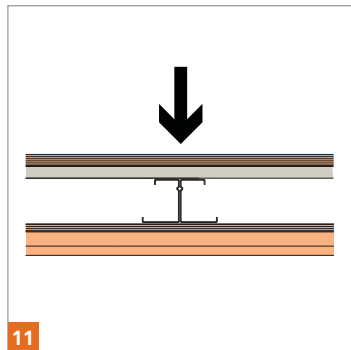

- Battens can be installed back to back to provide additional support as necessary



- Where specified, Isover glass mineral wool is laid within the cavity between the battens.



- Where specified, Gyproc Plank is laid perpendicular to the battens and staggered with a minimum 10mm expansion gap left around the perimeter. The ends of the Gyproc Plank should be supported by a Gypframe Steel Batten. Gyproc Plank is fitted by lightly butting edges together. No screw-fixings are required, however, screws can be used to aid installation by securing boards in place.



- Tongue and groove chipboard is laid perpendicular to the Gyproc Plank, with a minimum stagger of 150mm. A minimum 10mm expansion gap is left around the perimeter. Apply glue (as recommended by the chipboard manufacturer) to the tongued joints before butting together. Excess glue should be removed from the face of the chipboard before it dries by using a damp cloth.

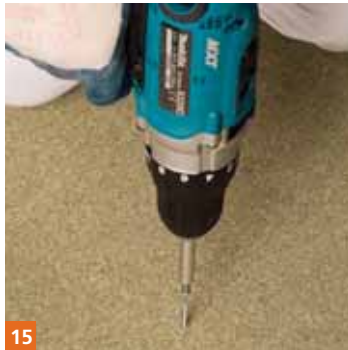

- Gypframe SIF5 Floor Screws are suitable for fixing the walking surface to the battens.

NB All fixings into **GypFloor sb** sections should protrude through the top of the section a minimum 10mm, but not protrude through the whole section.



- To fix skirting boards, first fold protruding flanking strip onto the face of the flooring. The skirting is then fixed as normal, so that it rests on the flanking strip. Any excess flanking strip can be trimmed flush to the face of the skirting.



17

Services

● Services are incorporated into the **GypFloor SB** system by allowing a gap in the sections. The gap should be 25mm from either side of the service. If access is required, a floor hatch can be formed from the flooring material (i.e. chipboard, or chipboard and Gyproc Plank).

- Gyproframe Steel Battens should be positioned around the perimeter of the hatch to support the hatch and the main floor. As a guide, maximum hatch size should not be greater than the batten spacing (400 X 400mm or 600 x 600mm maximum).

Thermal lining system for semi-exposed soffits

SoffitLine combines the aesthetic benefits of Glasroc MultiBoard with thermally efficient phenolic foam insulation. It can be directly fixed to the underside of semi-exposed soffits or using the **GyLyner** system or **CasoLine mF** system. The smooth, off-white surface finish of Glasroc SoffitLine makes it ideal for carports and basements where the panels can be left undecorated.



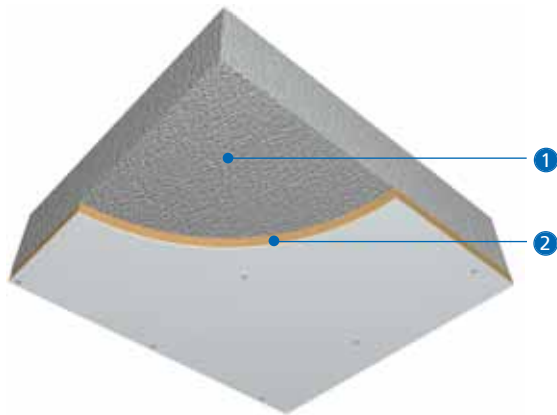

- 1 Semi-exposed soffit
- 2 Glasroc SoffitLine

Key facts

- Ideal for semi-exposed situations
- Smooth, durable surface
- High thermal efficiency
- Off-white surface can be painted or left undecorated
- Choice of fixing methods

Components

Glasroc board products



Glasroc SoffitLine

Comprises 6mm Glasroc MultiBoard with a backing of foil faced CFC and HCFC-free phenolic foam providing integral vapour control and a high level of thermal insulation.

Take-off quantities¹

100m²

Thickness	26, 36, 46, 56, 66, 76, 86mm
Width x Length	1200 x 2400mm

¹ Quantities are for 100m² of ceiling lining and are approximate and for guidance only, no allowance has been made for waste.

² 86mm thick Glasroc SoffitLine should be fixed using a proprietary fixing by others, providing a minimum 10mm penetration into metal sections and 25mm penetration into timber. When fixing 76mm thick Glasroc SoffitLine to timber, use proprietary fixings by others.

Fixing and finishing products

Option 1 - fixing to GypLyner UNIVERSAL



Gypframe GL1 Lining Channel

Main support section.

Prime dimensions	45 x 18mm
Length	2400, 2700, 3000, 3600mm

168 m



Gypframe GL8 Track

Prime dimensions	30 x 20 x 20mm
Length	3600mm

subject to ceiling perimeter



Gypframe GL2 Bracket

Fixing to structure.

Length	195mm
--------	-------

135



Gypframe GL9 Bracket

Fixing to structure where greater extension is required.

Length	295mm
--------	-------



135



Gyproc Drywall Screws²

For fixing Glasroc SoffitLine to metal framing.

525

Fixing and finishing products	Take-off quantities ¹						
Option 2 - fixing to CasoLine MF							
 <p>Gypframe MF5 Ceiling Section Main support section.</p> <table border="0"> <tr> <td>Prime dimensions</td> <td>80 x 26mm</td> </tr> <tr> <td>Gauge</td> <td>0.5mm</td> </tr> <tr> <td>Length</td> <td>3600mm</td> </tr> </table>	Prime dimensions	80 x 26mm	Gauge	0.5mm	Length	3600mm	168 m
Prime dimensions	80 x 26mm						
Gauge	0.5mm						
Length	3600mm						
 <p>Gypframe MF6 Perimeter Channel Perimeter support for MF5s.</p> <table border="0"> <tr> <td>Prime dimensions</td> <td>20 x 27 x 30mm</td> </tr> <tr> <td>Gauge</td> <td>0.5mm</td> </tr> <tr> <td>Length</td> <td>3600mm</td> </tr> </table>	Prime dimensions	20 x 27 x 30mm	Gauge	0.5mm	Length	3600mm	subject to ceiling perimeter
Prime dimensions	20 x 27 x 30mm						
Gauge	0.5mm						
Length	3600mm						
 <p>Gyproc Drywall Screws² For fixing Glasroc SoffitLine to metal framing.</p>	525						

Fixing and finishing products	Take-off quantities ¹		
Option 3 - fixing direct to soffit			
<p>Proprietary concrete fixings (by others).</p>	975 per 100m ²		
Option 4 - fixing via timber battens			
 <p>Gyproc Drywall Timber Screws² For a positive direct fix of boards to timber battens.</p> <table border="0"> <tr> <td>Length</td> <td>51, 60mm</td> </tr> </table>	Length	51, 60mm	525
Length	51, 60mm		

Construction tips

- Glasroc SoffitLine is suitable for semi-exposed applications such as soffits and car-ports, where perimeters are open to the elements. The phenolic foam insulation in Glasroc SoffitLine has a closed cell structure giving it good resistance to moisture
- Glasroc SoffitLine must not be subjected to direct exposure to the elements such as driving rain
- Consider finishing requirements. The board surface can be left undecorated but colour matching can not be guaranteed – there may be slight variations. The application of two coats of exterior quality paint after joint treatment will provide consistent appearance and enhanced durability
- Consider any requirements for condensation control. Glasroc SoffitLine offers significant resistance to water vapour transmission provided that all board joints are taped and filled
- Install Glasroc SoffitLine where there is a thermal requirement. It will reduce heat loss from the building and can reduce the risk of surface condensation occurring at cold bridges e.g. around openings
- Consider fixing method - either to metal / timber framework or direct to the soffit

Construction tips (cont'd)

- Fixtures - ensure that the fixing device selected is long enough to give adequate penetration into either the framing member or the soffit
- **Deflection** - metal framing - normal 600mm framing centres will achieve a deflection criteria of $L/360$. Where deflection criteria are more stringent, framing centres will need to be reduced to 400mm

Installation

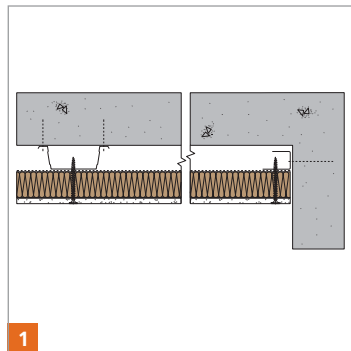

Fixing to concrete soffit with metal framing supports

- Locate Gypframe MF5 Ceiling Section at 600mm centres.
- Fix to the soffit using suitable fixings spaced at 1200mm centres, two fixings at each point, one in each leg of the Gypframe MF5 Ceiling Section.

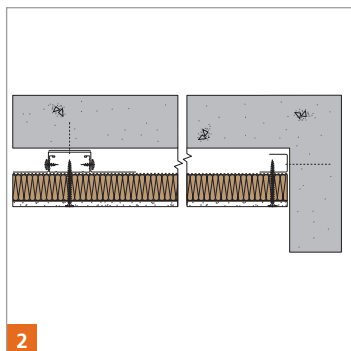

- Where boards are to be fixed to GypLyner, locate framing as normal (refer to section 6 - GypLyner UNIVERSAL) using channel and screw centres as for Gypframe MF5 Ceiling Section previously.

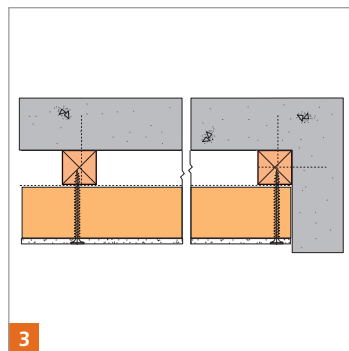

Fixing to concrete soffit with timber batten supports

- Locate timber battens at maximum 600mm centres.
 - Battens should be fixed using suitable fixings spaced at 1200mm centres.
- NB** Normal 600mm framing centres will achieve deflection criteria of $L/360$. Where deflection criteria are more stringent, framing centres will need to be reduced to 400mm.

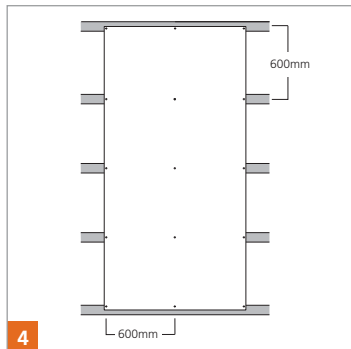

Fixing to metal framing

- Fix boards at right angles to the section.
- Use Gyproc Drywall Screws of a sufficient length to allow a nominal 10mm penetration into the metal.
- Insert screws at 600mm maximum centres into the field of the boards and at board ends.

Fixing to timber framing

- Position boards at right angles to the battens.
- Fix using Gyproc Drywall Timber Screws or Gyproc Drywall Screws of a sufficient length to allow a nominal 25mm penetration into the timber.
- Insert screws at 600mm centres into the field of the board and at board ends.

Fixing direct to the soffit

- Use proprietary concrete fixings, and insert at 400mm maximum centres.
- NB** Good standards of thermal insulation can be achieved although there may be a slight risk of pattern staining where temperature, humidity, and soiling conditions are extreme.

Frameless structural steel encasement system

FireCase frameless encasement system provides a high quality cladding to structural steel, and offers up to 120 minutes fire protection. The system affords protection to universal steel columns and beams, together with many joist and castellated beam sections. It can be used in any type of building where an encasement is required to structural steelwork. The Glasroc FireCase s lining provides a smooth, robust surface and there is no requirement to joint or apply a decorative treatment.



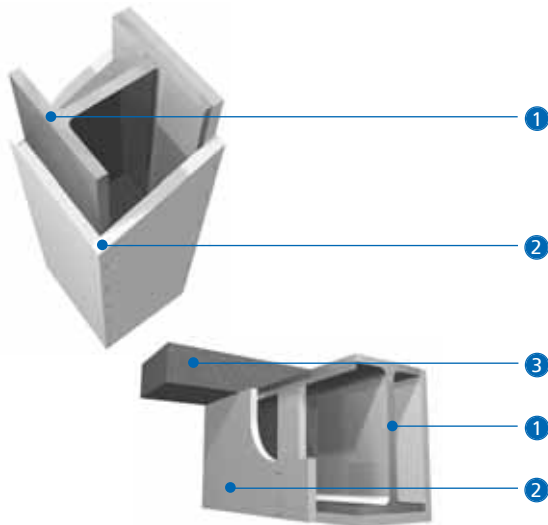

- 1 Structural steel section
- 2 Glasroc FireCase s cladding
- 3 Concrete structure

Key facts

- Glasroc FireCase s cladding provides a smooth, impact resistant surface
- Option of staple fixing for faster installation
- High levels of fire protection to structural steel
- Can be installed early in the build programme
- Simple and quick to install
- Non-combustible system
- Jointing and finishing is not required to meet the fire protection period

Components**Glasroc board products****Glasroc FireCase s**

Thickness	15, 20, 25, 30mm
Width	600, 1200mm
Length	2000, 2400, 3000mm

Take-off quantities¹

as required

Fixings**Pulsa Staples**

50mm long. Use with cordless Pulsa IM200/50 Stapler (available from Gyproc Tools) for board-to-board fixing (except 30mm board).

as required

or**Glasroc FireCase Screws**

For board-to-board and board-to-Gypframe metal fixing.

Length 40, 50, 58, 70mm

as required

Gypframe metal sections**Gypframe GA1 Steel Angle**

Width	25 x 25mm
Gauge	0.55mm
Length	2900mm

Take-off quantities¹

as required

Fixing and finishing products**Gyproc Joint Cement**

For decorative seamless jointing.

as required

**Thistle Multi-Finish or Thistle Board Finish**

Providing a plaster finish as an alternative to jointing.

as required

or**Thistle Durafinish**

To provide improved resistance to accidental damage.

as required

or**Thistle Spray Finish**

Gypsum finish plaster for spray or hand application.

as required

¹ Quantities will vary according to structural steel section dimensions.

Construction tips

- Estimated construction time is as follows:

4-sided protection – single layer	4m ² / man hour
4-sided protection – multi layer	3m ² / man hour
3-sided protection – single layer	3m ² / man hour
3-sided protection – multi layer	2.5m ² / man hour
- Select the correct thickness of Glasroc FireCase s. This depends on the section factor, A/V (Hp/A), and the degree of fire protection required – refer to specification.
 - **NB** Maximum A/V (Hp/A) = 260m⁻¹, calculated on the basis of box protection to 3 or 4 sides as required
- Boards should be cut to width using a suitable saw. Use a mechanical saw with dust extraction facility where the cutting requirement is substantial. British Gypsum offer a Glasroc Table Saw Kit designed for this purpose. For details of purchase or hire costs, contact Gyproc Tools on 0115 945 6100
- Consider hire or purchase of Pulsa IM200/50 Stapler for staple fixing. Contact Gyproc Tools for details
- Fix partitions and wall linings directly to the Glasroc FireCase s cladding (subject to certain conditions – see ‘Installation, Partition fixing’, later)

Construction tips (cont'd)

- Plan the cutting operations – where Glasroc FireCase s soldiers are specified it will be preferable to pre-cut these in advance of installation
- Where the steel section web dimensions exceed 600mm, additional support will be required for the cladding. Contact the British Gypsum Drywall Academy Technical Advice Centre for guidance
- Glasroc FireCase s joints are treated using Gyproc Joint Tape bedded in Gyproc Joint Cement. External angles / corners can be reinforced using Gyproc No-Coat Ultraflex 325 bedded in Gyproc Joint Cement. If a plaster finish is required, joints should be reinforced and Thistle Board Finish or Thistle Multi-Finish applied
- **Quantities** - Will vary according to structural steel section dimensions

Installation



Site cutting

- Cut boards using a suitable mechanical saw. The Glasroc Table Saw Kit is recommended.

Table 1 - Screw-fixing (board-to-board)

Glasroc FireCase s board thickness mm	Glasroc FireCase s Screw length mm
15	40
20	50
25	58
30	70

Fixing considerations

- Staple-fix boards (apart from the 30mm board) using a Pulsa Stapler and 50mm galvanised staples, or screw-fix using Glasroc FireCase Screws. Insert fixings throughout at 150mm centres. When fixing to steel angles, screws should penetrate by a minimum of 10mm.

NB If screw-fixing, the appropriate length of screw should be selected (see Table 1).



Four sided protection to steel columns

- Commence cladding from the base of the column through to the structural soffit.
- Cut two full length boards to the width of the section, and one half length board to the depth of the section, plus twice the thickness of Glasroc FireCase s board to cover the thickness of first layer boarding.
- Position the boards and staple-fix board-to-board using a Pulsa Stapler or alternatively Glasroc FireCase Screws of appropriate length.
- Cut a second half-length board, position against the opposite flange and install fixings.



- Position full length boards, cut to the depth of the section, plus twice the thickness of Glasroc FireCase s boards to cover the thickness of first layer boarding, and install fixings.
- Continue boarding in the same manner progressively working up the column. To complete the cladding, cut boards to suit and fix.
- **!** Stagger joints by a **minimum** of 300mm. Ensure that boards are cut square to maintain tight butt joints with no gaps.



4

Double layer linings

- Install outer layer boards as per the first layer, staggering board joints between layers by a minimum of 300mm. Cut boards to width, making the additional allowance necessary to cover the thickness of first layer boarding.



5

Three sided protection to steel columns incorporating steel angles

- Locate Gypframe GA1 Steel Angle to both sides of the wall flange. Position such that the face of the angle section is level with the edge of the flange and secure using appropriate fixings (e.g. shot fired to column) at 600mm maximum centres.

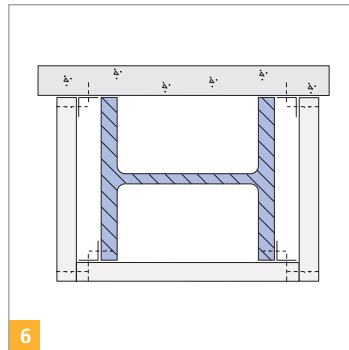

6

- Incorporate additional Gypframe GA1 Steel Angles where the column flange is at right angles to the wall structure.



- Cut two full length boards to the depth of the section plus the thickness of Glasroc FireCase s board. Position to opposite sides of the steel section and screw-fix to the Gyproframe GA1 Steel Angles at 150mm centres.



- Cut a half length board to the width of the section, position between abutting Glasroc FireCase s boards and fix using staples or screws. Position a full length board, again cut to the width of the section, and install fixings.
- Continue boarding in the same manner progressively working up the column. To complete the cladding, cut boards to suit and fix.



Double layer linings

- Install outer layer boards as per the first layer, staggering board joints between layers by a minimum of 300mm. Cut boards to width making the additional allowance necessary to cover the thickness of first layer boarding.

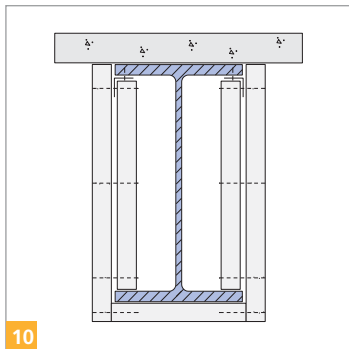

10

Three sided protection to steel beams incorporating steel angles

Proceed as for columns with the following exception detailed right:



11

- For single layer encasements, back fascia board joints with Glasroc FireCase s. Cut strips of Glasroc FireCase s minimum 60mm wide and staple or screw-fix behind fascia board ends so as to half-lap the joints.



12

Three sided protection to steel columns and beams incorporating Glasroc FireCase s soldiers to support single layer fireproofing providing up to 90 minutes fire protection

- Pre-cut Glasroc FireCase s soldiers to fit neatly into the steel section. Locate into both sides of the section at 1200mm maximum centres as boarding progresses.



- At fascia board joints fit two soldiers side by side so that each one finishes flush with the board end.

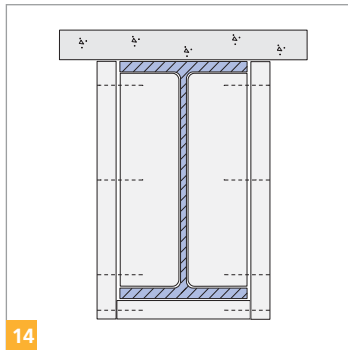

- Fix cladding to each joint soldier and also any intermediate soldiers using three staples or Glasroc FireCase Screws.



- Continue boarding, staggering board joints and fixing board-to-board as previously.



Partition fixing

- Fix partitions and wall linings directly to the Glasroc FireCase s cladding subject to the following conditions being met:
 1. The fire resistance requirement of the partition is 60 minutes or less.
 2. There are no special requirements for pressure resistance e.g. around lift shafts.
 3. There are no special loading requirements i.e. Heavy Duty or Severe Duty as defined in recognised partition performance specifications (e.g. *BS 5234*).



Proceed as follows:

- Apply a bead of Gyproc Sealant to the back of the channel or stud (two beads for components over 75mm width).

- Press the channel or stud into position against the lining.



- Screw-fix at 600mm centres into the Glasroc FireCase s using Gyproc Drywall Screws (25mm minimum). Additional FireCase s packers may be required when abutting flanges of steelwork where the encasement is less than 25mm.

- Allow at least 24 hours before boarding the partition.

NB Where the previous conditions are not met, the partition framing must be suitably fixed to the structural steel section, through the Glasroc FireCase s cladding. Where the partition abuts the web of the structural steel, **Z** bars (supplied by others) should be provided to give a fixing point for the partition framing. The **Z** section must be adequately fixed and its dimensions determined by the designer.

Junction details – column in the line of block walls

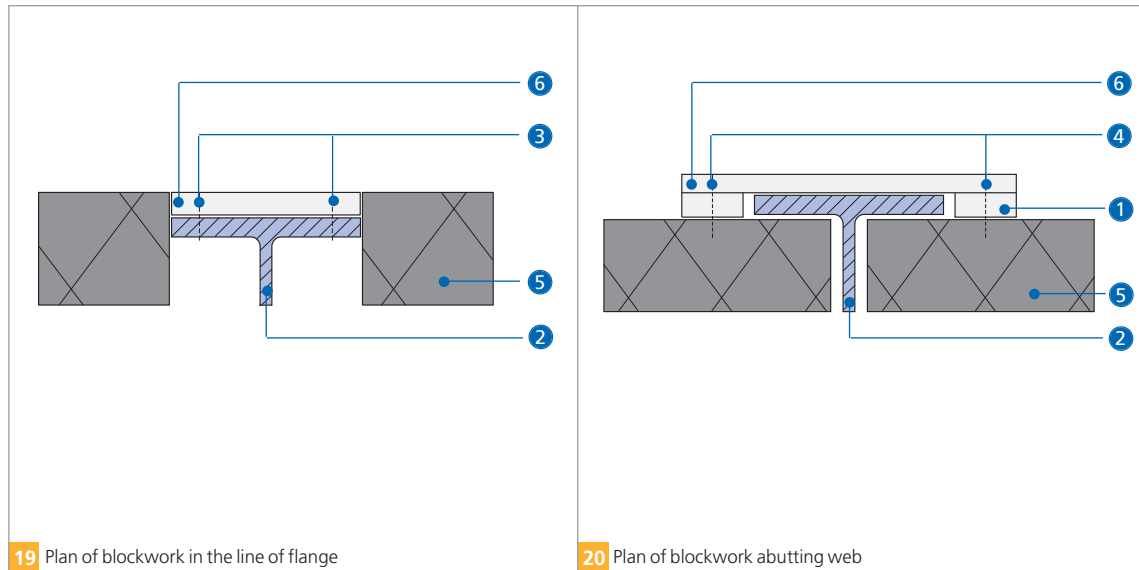

- ① Glasroc FireCase s packer
- ② Structural steel section
- ③ Mechanical steel pin fixings at 300mm vertical centres, staggered by 150mm in each vertical row

- ④ Suitable fixing through Glasroc FireCase s packer (cut on site) into blockwork at 600mm centres. Lining boards fixed at 150mm centres using 40mm Glasroc FireCase Screw
- ⑤ Blockwork
- ⑥ Glasroc FireCase s

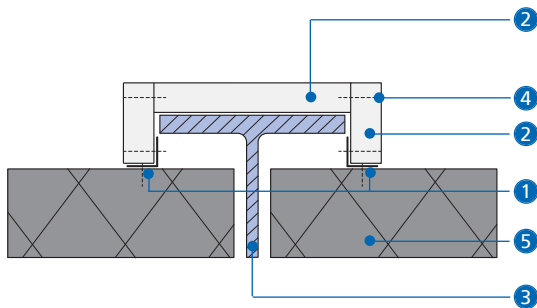

21 Plan of blockwork abutting web where steelwork flange is off-set from blockwork

- 1 Gypframe GA1 Steel Angle fixed to blockwork with suitable fixings at 600mm centres
- 2 Glasroc FireCase s
- 3 Structural steel section

- 4 Glasroc FireCase Screws or Glasroc Staples
- 5 Blockwork

GypLyner framed structural steel encasement system

GypLyner ENCASE is a steel encasement system which provides a rapid method of cladding structural steel sections to provide up to 180 minutes fire resistance. The system will protect universal column and beam sections, with flange thicknesses between 6mm and 28mm, and will also protect many joist sections, portal frames, and castellated beam sections. It can be used in any type of building where encasement is required to structural steel.



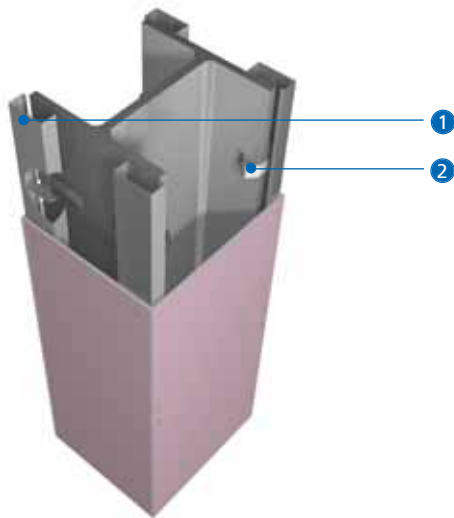

- 1 Gypframe GL1 Lining Channel
- 2 Gypframe GL10 GypLyner Steel Framing Clip

Key facts

- Quick and simple to install
- Lightweight support framework constructed from GypLyner components
- Easy to box-out
- High levels of fire protection to structural steel
- Up to 180 minutes fire protection

Components**Gyproc and Glasroc board products**

			Take-off quantities ¹
	Gyproc FireLine² Thickness 12.5, 15mm Width 900, 1200mm		as required
	Gyproc DuraLine² Thickness 15mm Width 1200mm		as required
	Glasroc FireCase s Thickness 15, 20, 25, 30mm Width 600, 1200mm		as required
	Glasroc MultiBoard Thickness 6, 10, 12.5mm Width 1200mm		as required





¹Quantities will vary according to structural steel section dimensions.

²Moisture resistant boards are specified in intermittent wet use areas e.g. shower cubicles.

Gypframe metal products

		Take-off quantities ¹
	Gypframe GL1 Lining Channel Length 2400, 2700, 3000, 3600mm	as required
	Gypframe GL3 Channel Connector	as required
	Gypframe GL10 GypLyner Steel Framing Clip	as required
	Gypframe GA2 Steel Angle Length 3200mm	as required

Fixing and finishing products	Take-off quantities ¹
 <p>Gyproc Drywall Screws For fixing boards to framing.</p>	as required
 <p>Gyproc Wafer Head Drywall Screws For fixing channel noggings to Gypframe GL1 Lining Channel.</p>	as required
 <p>Gypframe GFS1 Fixing Strap Length 2400mm</p>	as required
 <p>Gypframe GFT1 Fixing 'T' Length 2400mm</p>	as required

Fixing and finishing products	Take-off quantities ¹
 <p>Gyproc jointing materials For a seamless jointing.</p>	as required
 <p>Thistle Multi-Finish or Thistle Board Finish Providing a plaster finish as an alternative to jointing.</p> <p>or</p>  <p>Thistle Durafinish To provide improved resistance to accidental damage.</p>	as required
<p>or</p>  <p>Thistle Spray Finish Gypsum finish plaster for spray or hand application.</p>	as required

Construction tips

- Estimated construction time is 6m^2 / man hour (single layer encasement) or 3m^2 / man hour (multi-layer encasement) ready for finishing
- Determine if encasement needs to be boxed-out e.g. to achieve a specific common dimension or to build out beyond fixing bolts
- Partitions and wall linings can be fixed through to the metal framework
- Where the steel section web or flange dimension exceeds 600mm, additional support will be required for the cladding (see **Installation – Additional support**)
- Select the correct type and thickness of board. This depends on the section factor, A/V (H_p/A), and the degree of fire protection required. Refer to the specification
 - **NB** Maximum A/V (H_p/A) = $260-1$, calculated on the basis of box protection to 3 or 4 sides as required

Installation



Four-sided protection to steel columns

- Friction-fit Gypframe GL10 Steel Framing Clips onto the column flanges.

- Position Gypframe GL10 clips within 100mm of the base and soffit, and at intervals in between (800mm maximum centres).

 Ensure that clips are fully engaged so that each row is in alignment.



- The Gypframe GL1 Lining Channel stand off from the face of the structural steel frame is 25mm and 10mm from the edge of the flange.

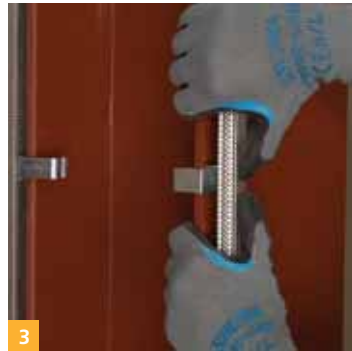

- Snap Gypframe GL1 Lining Channel section over the clips to form the steel framework.

NB Where lengths of Gypframe GL1 Lining Channel abut, position Gypframe GL10 clips to either side to provide a fixing support to each channel end (i.e. two Gypframe GL10 clips to each 'joint') or alternatively use Gypframe GL3 Channel Connectors to join the Gypframe GL1 Lining Channels.



- Cut boards to width and fix to all framing members at 300mm centres using Gyproc Drywall Screws. Start with a half length board on opposite sides to stagger board joints around the column.

NB Select the length of Gyproc Drywall Screw to provide a nominal 10mm penetration into the steel framing.

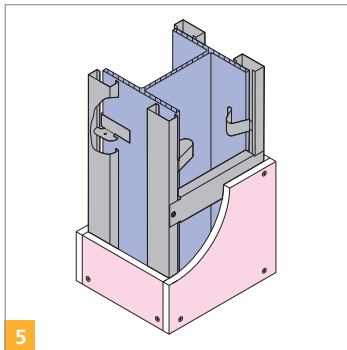

- Cut short lengths of Gypframe GL1 Lining Channel (**Figure 5**) or Gypframe GFT1 Fixing 'T' (**Figure 6**) so as to form horizontal noggings to back board end joints.

NB If the steel section web or flange dimension exceeds 600mm, a nogging should be formed from Gypframe GL1 Lining Channel installed at 600mm intervals (see **Installation – Additional support**).



- Fix to vertical channels using Gyproc Wafer Head Drywall Screws, and when board fixing provide an intermediate screw-fixing through each board end into the nogging.

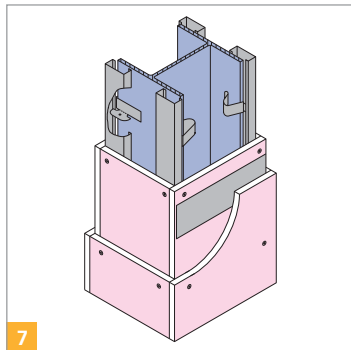

- Continue cladding in the same manner progressively working up the column.
- To complete the encasement, cut boards to suit and screw-fix.

Multi-layer linings

- Locate a short length of Gypframe GFS1 Fixing Strap behind board joints at right angles to the Gypframe GL1 Lining Channels.
- Install board layers as per the first layer, staggering board joints between each layer. Cut boards to width making the additional allowance necessary to cover the thickness of the previous board layer.



Three-sided protection to steel columns and beams

- Locate Gypframe GA2 Steel Angle to both sides of the wall/soffit flange. Position such that the face of the angle section is level with the edge of the flange and secure using appropriate fixings (e.g. shot fired into steel) at 600mm maximum centres.



- Friction fit Gypframe GL10 clips to both edges of the room facing flange. Position at 800mm maximum centres, ensuring that adjacent clips are in alignment.
- Snap Gypframe GL1 Lining Channel over the clips to form the steel framework.

NB Where lengths of Gypframe GL1 Lining Channel abut, position Gypframe GL10 Clips to either side to provide a fixing support to each channel end (i.e. **two** Gypframe GL10 clips to each 'joint'), alternatively use Gypframe GL3 Channel Connectors to join the Gypframe GL1 Lining Channels.



- Cut boards to width and fix to all framing members at 300mm centres using Gyproc Drywall Screws. Start with a half length board on opposite sides to stagger board joints.
- NB** Select the length of drywall screw to provide a nominal 10mm penetration into the steel framing.

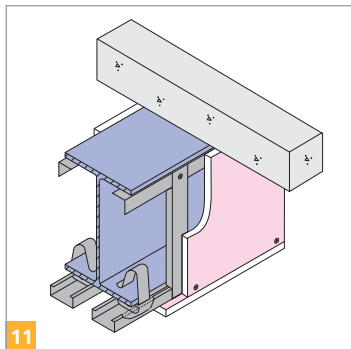

- Install Gypframe GL1 Lining Channel or Gypframe GFT1 Fixing 'T' noggings to support board end joints as for four sided encasements.
- Continue boarding in the same manner progressively working up the column or along the beam.
- To complete the encasement, cut boards to suit and screw-fix.

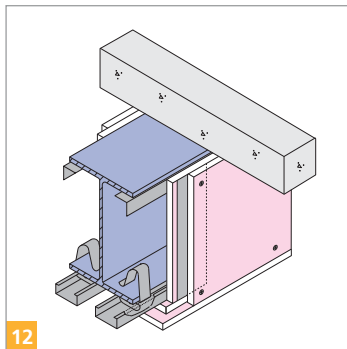

Multi-layer linings

- A short length of Gypframe GFS1 Fixing Strap is located behind board joints at right angles to the Gypframe GL1 Lining Channels.
- Install outer layer boards as per the first layer, staggering board joints between each layer by a minimum of 600mm. Cut boards to width making the additional allowance necessary to cover the thickness of the previous board layer.

Additional support

- Where the steel section web or flange dimensions exceed 600mm, additional support will be required for the cladding.
- Fix noggings of Gypframe GL1 Lining Channel at 600mm centres between adjacent Gypframe GL1 Lining Channels, to supplement the framing. Position noggings to coincide with board end joints.

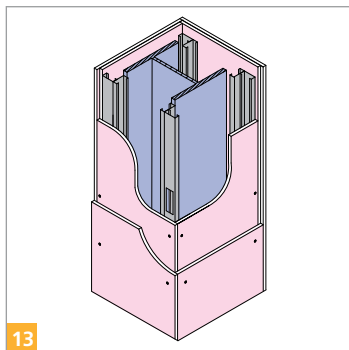

Boxing out

- Extend encasements by installing a Gypframe metal stud and channel framework independent of the steel lining height.

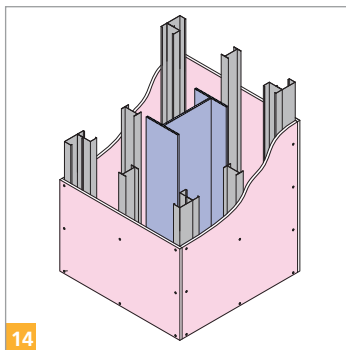

- Use intermediate Gypframe 'T' Stud to maintain board support at maximum 600mm centres.
- See **GypLyner iwl** for guidance.



Additional fire protection

- Where 180 minutes fire protection is required (to columns only), Glasroc FireCase s is specified as the cladding. Fix Glasroc FireCase s boards through to the metal framing as for Gyproc FireLine or Glasroc MultiBoard, using appropriate length Gyproc Drywall Screws.

Plaster systems

Thistle plaster systems are available for two / three-coat hand application, one-coat hand application and one-coat machine application. Thistle plasters have been formulated to suit a wide variety of background types including concrete, brick, blockwork, sand / cement, expanded metal lath and plasterboard. The Thistle range also includes associated beads, reinforcing tapes and bonding agents. These have been manufactured, selected and tested to work reliably with Thistle plasters.



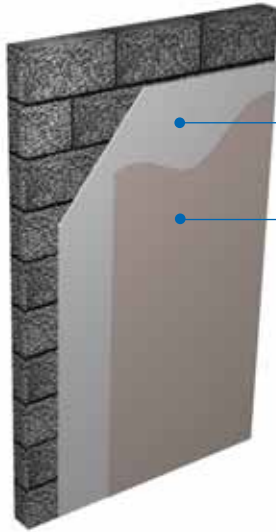







- 1 Undercoat plaster
- 2 Finish plaster

Key facts

- One, two / three - coat options
- Hand or machine application
- Free from inherent shrinkage cracking
- Controlled setting times
- Resilient and scuff-resistant for general purposes, and excellent resistance to accidental damage provided by Thistle Durafinish
- Grades to suit most internal solid backgrounds
- Proven products



Components

Thistle undercoat plasters	Nominal bag weight (kg)	Shelf life (months) ²	Quantities ¹	Nominal bag weight (kg)	Shelf life (months) ²	Quantities ¹	
 Thistle Bonding Coat An undercoat plaster for smooth or low suction backgrounds (e.g. concrete, plasterboard or surfaces treated with bonding agents).	25	4	2.75m ² per bag at 11mm	 Thistle Browning An undercoat plaster for solid backgrounds of moderate suction with an adequate mechanical key.	25	4	3.5m ² per bag at 11mm
 Thistle Hardwall An undercoat plaster with high impact resistance and quick drying surface for masonry backgrounds. Suitable for application by hand or mechanical plastering machine.	25	4	3.0m ² ³ per bag at 11mm	 Thistle Dri-Coat A cement-based undercoat plaster for application after installation of a damp proof course.	25	6	3.25m ² per bag at 11mm
 Thistle Tough Coat An undercoat plaster with high coverage, good impact resistance and a quicker drying surface for masonry backgrounds.	25	4	3.5m ² ³ per bag at 11mm	 Thistle X-Ray An undercoat plaster giving protection from x-rays in medical and dental installations.	25	4	0.4m ² per bag at 25mm

¹ Quantities are approximate and for guidance only, no allowance has been made for waste.





² Use by date is printed on each bag.

³ Approx. 10% less if sprayed.

Thistle finish plasters	Nominal bag weight (kg)	Shelf life (months) ²	Quantities ¹
 <p>Thistle Board Finish 25 4 A final coat plaster for low-medium suction backgrounds (e.g. plasterboards and Thistle Dri-Coat).</p>			10m ² per bag at 2mm
 <p>Thistle Multi-Finish 25 4 A versatile final coat plaster.</p>			10m ² per bag at 2mm
 <p>Thistle Durafinish 25 4 To provide improved resistance to accidental damage.</p>			10m ² per bag at 2mm
 <p>Thistle Spray Finish 25 4 Gypsum finish plaster for spray or hand application.</p>			11m ² per bag at 2mm
Thistle one-coat plasters			
 <p>Thistle Universal One Coat 25 4 A one-coat plaster for a variety of backgrounds. Suitable for application by hand or mechanical plastering machine.</p>			2.25m ² per bag at 13mm











Thistle one-coat plasters	Nominal bag weight (kg)	Shelf life (months) ²	Quantities ¹
 <p>Thistle Projection 25 4 A one-coat plaster for application by a mechanical plastering machine.</p>			2.0m ² per bag at 13mm
Thistle plaster accessories			
 <p>ThistleBond-it For pre-treatment of smooth backgrounds Tub contents 10 litre</p>			4.5m ² / litre
 <p>Thistle GypPrime Suction control primer for high suction backgrounds Tub contents 11 litre</p>			9m ² / litre undiluted. 27m ² / litre diluted 1:2. 54m ² / litre diluted 1:5.
 <p>Thistle Plaster Angle Bead For reinforcing external angles Length 2400, 3000mm</p>			as required
 <p>Thistle Plaster Stop Bead For finishing and reinforcing plaster edges Length 2400, 3000mm</p>			as required
 <p>Gyproc plaster tools A complete range of plastering tools and equipment.</p>			as required

Table 1 – plaster selection

		What is the background surface?													
		← suction →													
Undercoat solid plaster		Aircrete blocks	Common bricks	Medium-density blocks	Dense blocks	Engineering bricks with raked joints	Plasterboard & Glasroc F MULTIBOARD	Cast in situ & pre-cast concrete	Painted / tiled surfaces	Metal lathing	Thickness applied - Walls	Thickness applied - Ceilings	Coverage per bag (at 11mm)	Water requirement (litres per bag)	Dry set weight (at 11mm)
		Two coat	 Thistle Hardwall High impact resistance for most masonry backgrounds. Can be spray applied.				NOT ON SMOOTH LOW-SUCTION BLOCKS					WHEN BRIDGING COLUMNS AND LINTELS	11mm	8mm	3.0m ²
 Thistle Tough Coat High coverage for most masonry backgrounds. Can be spray applied.					NOT ON SMOOTH LOW-SUCTION BLOCKS					WHEN BRIDGING COLUMNS AND LINTELS	11mm	8mm	3.5m ²	17.5	8.5kg/m ²
 Thistle Browning For solid backgrounds with adequate key.	USE G IN EXTREME CASES										11mm	8mm	3.5m ²	17.5	8.4kg/m ²
 Thistle Bonding Coat For smooth and low suction backgrounds.					USE B ON SMOOTH LOW-SUCTION BLOCKS		USE B ON MR BOARDS	USE B	USE B		11mm	8mm	2.75m ²	14	12.1kg/m ²

Setting times: Thistle undercoat plasters - 1.5 to 2 hours. Thistle finish plasters - 1.5 hours or longer in cold weather.

Table 2 – plaster selection

		← What is the background surface? suction →													
		Aircrete blocks	Common bricks	Medium-density blocks	Dense blocks	Engineering bricks with raked joints	Plasterboard & Glasroc F MULTIBOARD	Cast in situ & pre-cast concrete	Painted / tiled surfaces	Metal lathing	Thickness applied - Walls	Thickness applied - Ceilings	Coverage per bag (at 11mm)	Water requirement (litres per bag)	Dry set weight (at 11mm)
One coat	 <p>Thistle Universal One Coat For hand or spray application to most backgrounds.</p>				 USE ON SMOOTH LOW-SUCTION BLOCKS		 USE ON MB BOARDS	 USE	 USE		13mm	10mm	2.25m ² at 13mm	15	15kg/m ² at 13mm
	 <p>Thistle Projection For application by a mechanical plastering machine.</p>				 USE ON SMOOTH LOW-SUCTION BLOCKS		 USE ON MB BOARDS	 USE	 USE	USE SPRAY LATH	13mm	10mm	2.0m ² at 13mm	Depends on machine settings	

Setting times: Thistle undercoat plasters - 1.5 to 2 hours. Thistle finish plasters - 1.5 hours or longer in cold weather.









Specialist plasters	 <p>Thistle Dri-Coat Cement based plaster for replastering after a damp-proof course.</p>	 <p>Thistle X-Ray For use in medical and dental installations.</p>
---------------------	---	--

Table 3 – plaster selection

Skim finish plaster		What is the background surface?					Thickness applied	Coverage per bag (at 2mm)	Water requirement (litres per bag)	Dry set weight (at 2mm thickness)
		← suction →								
		Dry undercoats	Damp undercoats	Plasterboard	Flat, smooth concrete	Waterproofed cement-based undercoats				
Skim coat	 <p>Thistle Multi-Finish A versatile plaster for skim finishing undercoats and plasterboards.</p>	DAMPEN BACKGROUND FIRST		USE  ON MR BOARDS	USE  ON MR BOARDS		2mm	10m ²	11.5	3.4kg/m ²
	 <p>Thistle Board Finish For low to medium suction backgrounds especially plasterboard.</p>			USE  ON MR BOARDS	USE  ON MR BOARDS		2mm	10m ²	11.5	3.4kg/m ²

Minimum temperature to be maintained until dry. +2°C for Thistle Board Finish and Thistle Multi-Finish

Suction control



Thistle GypPrime

Suction control primer used to reduce suction on very dry backgrounds. Use diluted (up to five parts water to one part Thistle GypPrime) or undiluted if severe suction control is required. Plaster is applied after Thistle GypPrime has soaked into the background.

 Use Thistle GypPrime where you see this symbol.

Bonding agent









ThistleBond-it

Bonding agent for smooth low-suction backgrounds. Apply undiluted, in one coat. Plaster when dry.

 Use ThistleBond-it where you see this symbol.

Table 4 – plaster selection

		What is the background surface?					Thickness applied	Coverage per bag (at 2mm)	Water requirement (litres per bag)	Dry set weight (at 2mm thickness)
		← suction →								
Skim finish plaster		Dry undercoats	Damp undercoats	Plasterboard	Flat, smooth concrete	Waterproofed cement-based undercoats				
Skim coat	 <p>Thistle Durafinish A versatile plaster that is 60% tougher than standard skim plasters.</p>	USE 	USE 				2mm	10m ²	11.5	3.4kg/m ²
	 <p>Thistle Spray Finish Gypsum finish plaster for spray or hand application.</p>			USE  ON MR BOARDS	USE 		2mm	11m ²	12	TBC

Minimum temperature to be maintained until dry. +5°C for Thistle Durafinish

Suction control



Thistle GypPrime
Suction control primer used to reduce suction on very dry backgrounds. Use diluted (up to five parts water to one part Thistle GypPrime) or undiluted if severe suction control is required. Plaster is applied after Thistle GypPrime has soaked into the background.

 Use Thistle GypPrime where you see this symbol.

Bonding agent



ThistleBond-it
Bonding agent for smooth low-suction backgrounds. Apply undiluted, in one coat. Plaster when dry.

 Use ThistleBond-it where you see this symbol.

Installation – background preparation

General

All surfaces should be reasonably dry and protected from the weather. The suitability of a particular background for plastering should be considered in relation to its strength, suction, bonding properties, shrinkage or thermal movement characteristics, water and soluble salt content. Very high or low suction substrates should be pre-treated. The use of ThistleBond-it is recommended for smooth backgrounds, whilst Thistle GypPrime is recommended for very high suction backgrounds. The high suction of certain backgrounds can be suitably adjusted by sprinkling with water.

Brickwork / blockwork

The surface must be clean, dry and suitable to receive gypsum plaster. Control suction with water if necessary. If suction is severe the background should be pre-treated with Thistle GypPrime.

On high suction brick / blockwork the use of Thistle Hardwall or Thistle Tough Coat is recommended.

Low suction backgrounds such as some concrete

blocks and engineering bricks provide minimal absorption. The joints should be raked thoroughly to give an adequate mechanical key. Smooth backgrounds should be pre-treated with ThistleBond-it.

Dense aggregate concrete blocks do not require wetting prior to plastering, but the plaster should be applied with very firm pressure to ensure intimate contact with the background.

Concrete

The surface must be clean, dry and suitable to receive gypsum plaster. Any mould oils or other agents present should be removed from the surface.

No-fines concrete does not require wetting prior to plastering.

Normal ballast concrete should be given sufficient time to mature before applying plaster. The plaster should not be applied onto a green background or when any free water is visible. Mature concrete will require wetting to displace the air before plastering. Clean water should be applied 5 - 10 minutes before plaster application.

In-situ or pre-cast concrete which is exceptionally smooth, or which is made from limestone, brick, granite and certain lightweight aggregates, always requires pre-treatment with ThistleBond-it.

In order to reduce the risk of cracking to a minimum, the floating coat should be applied with sufficient pressure to fill all gaps between the units.

With composite ceilings, the concrete beams should be pre-treated with ThistleBond-it. If required, the suction of the infill panels can also be controlled.

Composite wall structures, consisting of concrete columns with brick or block infills, can cause plaster cracking due to differential movement. To overcome this, a heavy duty building paper should be applied over the concrete columns, lapping over the brick or blockwork by a minimum of 25mm. Expanded metal lath is then fixed over the building paper and the edges secured to the brick or blockwork. By this means the reinforced plaster is isolated from the concrete allowing it to move independently.

Where the width of a column exceeds 300mm an additional row of fixings should be provided to secure

the metal lath centrally down the column. Where there are concrete beams above the infill bricks or blocks, the metal lath should also be fixed to the concrete using suitable fixings.

Pre-treatment of very high or low suction backgrounds

Backgrounds such as ceramic tiles, glazed bricks, exceptionally smooth concrete or concrete made from limestone, brick, granite and certain lightweight aggregates, will require preparation and pre-treatment with ThistleBond-it bonding agent prior to plastering. The surface should be thoroughly cleaned and allowed to dry before pre-treatment.

Thistle GypPrime bonding agent should be used to pre-treat surfaces where suction is extremely high. With some very porous surfaces, wetting alone may be insufficient as the water is almost immediately absorbed.

If there is any doubt about the suitability of a background for direct plastering, a trial panel should be plastered and tested for adhesion once dry. If adhesion is inadequate, the appropriate bonding agent must be applied to the background prior to plastering.

ThistleBond-it bonding agent is specially formulated for use on smooth backgrounds. It has many advantages over PVA and is the only product recommended by British Gypsum for use with Thistle plasters. Benefits include :

- Contains fine aggregates for better mechanical adhesion.
- Plaster is applied when dry, allowing flexible timing of application.
- Plaster can be applied at normal thickness (i.e. up to 13mm). Maximum 10mm on soffits.
- No dilution, so no confusion on site.
- Green coloured for ease of identification in application.

Thistle GypPrime bonding agent is specially formulated for the pre-treatment of very high suction backgrounds. It is the only product recommended for use with Thistle plasters. It can be diluted as required giving total flexibility, for different levels of suction control, and is yellow coloured for ease of identification.

ThistleBond-it and Thistle GypPrime should be applied strictly according to the user instructions. Care should be taken **not to exceed** the recommended plaster thickness, otherwise bond failure may result. Where a greater thickness of plasterwork is required, due to an uneven background for example, an alternative carrier for the plaster should be specified, such as metal lath.

Sand / cement undercoats

This method of plastering is now largely superseded by gypsum plastering. Obtaining the correct grade of sand and allowing sufficient time for drying shrinkage of the sand / cement are essential to reduce the risk of subsequent possible defects.

If sand / cement or sand / lime undercoats are used, the following points should be considered:

- Sand and cement will shrink on drying.
- Retarded ready-mixed sand / cement renders may delay shrinkage and may be incompatible with gypsum finish plasters.
- If finish coat plaster is applied too early, differential movement resulting from sand / cement shrinkage may cause cracking in the finish coat. This may not be detected when using retarded mortars for extended periods of time.
- Shelling of finish coat plaster from all types of sand / cement backgrounds can occur due to incomplete shrinkage, over-sanded undercoat and / or lack of mechanical key.
- The key provided to sand / cement by scratching needs to be much better than that to a gypsum undercoat.
- Suction should be adjusted by sprinkling with clean water just prior to plastering.

Expanded metal lath / beads

Plaster should only be applied to galvanised steel or

epoxy coated stainless steel. Before plastering, all cut edges, damaged metal lath, staples, nail heads and ends of tying wire should be bent inwards and adequately protected by galvanising, painting or by applying a thick coat of lacquer. Machine applied plaster requires the use of spray lath.

Replastering walls - general

Thistle Dri-Coat is recommended for application following installation of a damp proof course. In other replastering situations, the Thistle plaster designed for the equivalent new background should be used (normally Thistle Bonding Coat or Thistle Hardwall). The following general points should be noted:

- No plaster should be used below ground level as hydrostatic pressure can give rise to direct water penetration. A suitable tanking treatment must be specified in this situation.
- Heavy salt contamination in the background can cause persistent damp problems. Buildings such as old farmhouses, stables and barns not originally built with a damp proof course, or buildings that have been exposed to storage of chemicals, are particularly at risk from this problem.

Thistle Dri-Coat should **not** be used in these situations unless a proper survey shows that the risk from salts is minimal. An independent wall lining may be a better solution. Chimney breasts are another area where salt deposits may be heavy.

Replastering walls - following damp proof course treatment

Thistle Dri-Coat is the only British Gypsum plaster recommended for this application. The source of penetrating or rising dampness must be identified and eliminated. The existing plasterwork should be hacked off to a height at least 0.5m above either the new damp proof course or the last detectable sign of dampness. Where the old plaster is gypsum based, it must be completely removed from the area to be replastered. Ideally, replastering with Thistle Dri-Coat should be delayed as long as possible to allow the background to dry out. After chemical damp proof injection, old mortar joints which are the site of the higher salt concentrations should be thoroughly raked out and the face of the brickwork brushed with a wire brush. Before replastering work is carried out, any salts brought to the surface of the background during drying should be carefully removed.

Angle beads must **not** be fixed with gypsum based materials, use Thistle Dri-Coat.

The background must be clean, sound, and free from dust and efflorescence. Where only residual moisture is present, Thistle Dri-Coat can then be applied. Low suction or smooth backgrounds, such as engineering bricks, should be treated prior to plastering with a water-resisting bonding aid which should be plastered in accordance with the manufacturers' recommendations.

Where the background is dry, it is important to control suction with the application of water. This prevents rapid drying of the plaster which would impair its strength.

Replastering walls - general application

Where the wall to be replastered is damp, replastering should be delayed as long as possible to allow the background to dry out. Any source of penetrating dampness must be identified and eliminated. Before replastering, any salts brought to the surface of the background during drying should be carefully removed.

The background must be clean, sound, and free from dust and efflorescence. Where only residual moisture is present, Thistle undercoats can then be applied.

Construction tips

- For specialist applications, ensure the appropriate product is specified e.g. Thistle Dri-Coat for replastering after damp proof course installation, Thistle X-Ray for x-ray protection work or Thistle Durafinish for improved resistance to accidental damage
- Identify the type of background to be plastered. Refer to **Table 1** to determine the appropriate Thistle undercoat plaster and its recommended thickness
- Determine thickness required. Influencing factors include:
 - Finished dimensions of rooms
 - Thickness of grounds
 - Dimensions and positioning of joinery
 - Positioning of heating appliances and other fittings
 - Accommodation of services (minimum 5mm undercoat cover over conduits)
 - Fire resistance requirements
 - Where a bonding agent is required, the quoted thicknesses are the maximum
- Consider background preparation (see **Installation details**)
- Choose preferred method of application (one-coat or two / three-coat, hand or machine)

Construction tips (cont'd)

- Approximate coverages are given in **Table 1** and **Table 2**
- Check background for dampness. Thistle plasters should not be used to isolate dampness or be subjected to continuously moist or humid conditions
- Determine the routing of services. Conduits should be chased into the background if possible, should be of the minimum permissible dimensions and should avoid high spots in the background
- Install movement joints as required, corresponding with joints in the background
- In cold conditions, do not apply plasters to frozen backgrounds or allow them to freeze before fully set and dry. Remember that setting times of finishing plasters will be extended. Dry bagged plaster is not affected by cold temperatures. When using Thistle Durafinish ambient and background temperature must be maintained above 5°C until fully dry to obtain the full damage resistance
- In hot conditions, take precautions to avoid rapid 'dry-out' of the plaster, by dampening the background or, on very high suction backgrounds, using Thistle GypPrime prior to plastering. Once set and dry, Thistle plasters are suitable for use in temperatures up to 49°C
- Never apply plaster where a damp background is a recurring problem

Installation



Mixing

Undercoat plasters are pre-mixed with aggregate. Add **only** clean water to prepare them for use.

- Mix by hand or mechanical whisk (avoid excessive mechanical mixing).
- Use **only** clean water and clean mixing equipment.

NB Contamination from previous mixes can shorten the setting time and reduce the strength of the plaster when set.

- Use plaster projection machines where appropriate.

NB Thistle Hardwall, Thistle Tough Coat, Thistle Projection and Thistle Universal One Coat plasters can be mixed / applied using plaster projection machines.



Solid backgrounds

- Apply undercoat plaster with firm pressure.
- Build out to the required thickness in successive coats of approx. 8mm.
- Wire scratch each coat and allow to set before applying the next.
- Rule the final coat to an even surface and lightly scratch to form a key for Thistle Multi-Finish or Thistle Durafinish.



- Thistle Durafinish requires Thistle GypPrime to reduce the suction. A mix of 5 parts water to 1 part Thistle GypPrime should be applied to the undercoat plaster and left to fully dry prior to the application of Thistle Durafinish.

NB The maximum thickness of undercoat is 25mm. Greater thickness normally requires the use of a support for the plaster (e.g. metal lathing), spaced away from the background if necessary.

Backgrounds following dpc treatment

Thistle Dri-Coat is the only British Gypsum plaster recommended for this application.

- Allow initial curing and shrinkage of the scratched undercoat to take place prior to application of finish plaster.

NB In good drying conditions, a **minimum** delay of 24 hours is required. In cold / damp conditions or where background suction is low, a longer delay will be necessary. If sufficient delay is not allowed, cracking or shelling of the finish coat may result.

- Where the floor is solid, leave a 50mm gap between the plasterwork and the floor level. Under **no circumstances** should the damp proof course be bridged.

Metal lath

- Using Thistle Bonding Coat, apply a pricking-up coat, forcing it through the metal lath in order to provide a good key to the background.
- Wire scratch the surface of the pricking-up coat to provide a good key for the floating coat.
- Allow to set but not dry, before applying a floating coat.

NB Floating coats should be applied at a coat thickness not exceeding 25mm, and deep wire-scratched between each coat.

- Rule the final floating coat to an even surface and lightly scratch to form a key for Thistle Multi-Finish or Thistle Durafinish.
- Apply finish plaster once undercoat is set but not dry.
- Thistle Durafinish requires Thistle GypPrime to reduce the suction. A mix of 5 parts water to 1 part Thistle GypPrime should be applied to the undercoat plaster and left to fully dry prior to the application of Thistle Durafinish.

Plasterboard (except skimming)

Where Thistle Bonding Coat and finish plaster are applied to plasterboards, Gyproc Joint Tape should be used to reinforce joints and angles.

- Pre-fill any gap between boards exceeding 3mm with finish plaster and spread along each joint.
- Press Gyproc Joint Tape firmly into the finish plaster, and immediately cover with a further application.
- Allow the joints to stiffen, but not dry, before applying undercoat plaster.

- Apply Thistle Bonding Coat with firm pressure.
- Build out to the recommended thickness, rule to an even surface and lightly scratch to form a key for Thistle Multi-Finish or Thistle Durafinish.
- Apply finish plaster once undercoat is set but not dry.
- Thistle Durafinish requires Thistle GypPrime to reduce the suction. A mix of 5 parts water to 1 part Thistle GypPrime should be applied to the undercoat plaster and left to fully dry prior to the application of Thistle Durafinish.



One-coat hand plastering

- Apply Thistle Universal One Coat with firm pressure.
- Build out to the recommended thickness, rule to an even surface and fill in any slacks or hollows.
- As the plaster stiffens, carry out further flattening and paring.
- When the plaster is sufficiently firm, scour the surface with a sponge float and water as required, to raise 'fat' to the surface.
- When sufficiently firm, progressively trowel the plaster to a smooth matt finish.



Projection machine

- Spray Thistle Projection, Thistle Hardwall, Thistle Universal One Coat or Thistle Tough Coat on to the background in the form of a ribbon.
 - The consistency should allow the ribbons to run together.
 - When a substantial area has been covered, work the plaster and rule as in hand plastering.
- NB** It is easier to attain the required thickness of plaster in one application by machine, but the total thickness should not normally exceed 25mm, subject to background suitability.

X-ray protection

- Use Thistle X-Ray plaster and apply to the thickness specified by the specifier. For further guidance, please contact the British Gypsum Drywall Academy Advice Centre.

Replacing plasterwork

Damaged, insecure or defective plaster can be renewed as follows:

- Strip off existing plaster from the affected area.
- Clean the exposed background and remove any dust.

- Apply ThistleBond-it to smooth, low suction backgrounds, Thistle GypPrime to extremely high suction backgrounds.
- Apply appropriate Thistle undercoat plaster, build to the required thickness and scratch the surface.
- Apply 2mm of Thistle Multi-Finish once undercoat is set but not dry.
- To avoid downgrading the surface and system performance, Thistle Durafinish should be used where originally specified.

NB Always identify the cause of the problem and rectify before replastering.

Decoration

- Apply decorative treatment once plasterwork is thoroughly dry. Thistle finish plasters can be decorated with most proprietary paint finishes, and will accept most wallcovering adhesives.

NB Although gypsum based plasterwork must be dry before decorating, a coat of permeable paint can be applied in the interim.

Plaster skimming - Hand applied

Plaster skimming to plasterboards and Glasroc MultiBoard is a popular method of providing a smooth, seamless surface ready to receive decorative treatment. Skim plastering gives many of the advantages of a traditional plaster finish combined with quick turnaround on site. Surface preparation simply involves joint reinforcement and, if tapered edge board is used, flushing-out the tapers. The plaster is trowel-applied to the wall or ceiling surface to a 2mm thickness.



NB For details on the plaster skimming machine applied process, please see 'Plaster skimming - Machine applied' **SITE BOOK** supplement.

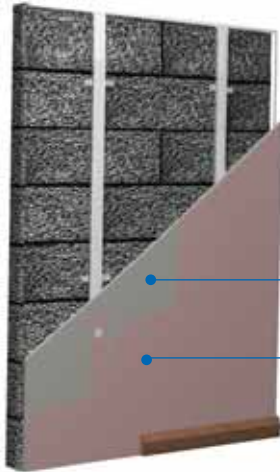

- 1 Plasterboard
- 2 Plaster

Key facts

- Traditional plaster finish
- Provides uniform surface
- Resilient and scuff-resistant for general purposes, and excellent resistance to accidental damage provided by Thistle Durafinish
- Applied to 2mm thickness
- Finished in one visit to site
- ConstructionSkills grant-approved training

Components

Plaster products



Thistle Board Finish

25kg

or



Thistle Multi-Finish

25kg

or



Thistle Durafinish

To provide improved resistance to accidental damage.

25kg

or



Thistle Spray Finish

Gypsum finish plaster for spray or hand application.

25kg

Quantities¹

Approx
1 bag
per 10m²Approx
1 bag
per 11m²

Plaster accessories



Thistle Thin-Coat Angle Bead

Length 2400, 3000mm

as required



Thistle Thin-Coat Mini Mesh Bead

Length 2400, 3000mm

as required

Plaster accessories



Thistle Thin-Coat Plaster Stop Bead

Length 2400, 3000mm
3mm thickness

As required



Thistle ProTape FT50

For reinforcing plasterboard joints.

Dimensions 50mm x 90m

150m per
100m²

Thistle ProTape FT100

For reinforcing plasterboard joints.

Dimensions 100mm x 45m

150m per
100m²

Gyproc Joint Tape

For reinforcing plasterboard joints and internal angles.

Roll length 150m

As required



ThistleBond-it

For pre-treatment of MR grade board surfaces.

Tub contents 10 litre

45m² per tub

¹ Quantities are approximate and for guidance only, no allowance has been made for waste.

NB Plasters and plaster accessories - see Section 12 – Products, 'Plaster and plaster accessories', or Gyproc Tools catalogue for full listing.

Construction tips

- Ensure the background is prepared properly, e.g. board fixed the correct way round (skim onto the front face of plasterboard and the smooth face of Glasroc MultiBoard), and reasonably clean and dry
- Select the right plaster system for the background, normally:
 - Thistle Board Finish for plasterboards and Glasroc MultiBoard
 - Thistle Multi-Finish where the job also involves finishing undercoats
 - Thistle Durafinish for improved resistance to accidental damage
 - Thistle Spray Finish for spray or hand application (see **SITE BOOK** supplement – ‘Plaster skimming - Machine applied’)
 - ThistleBond-it for skimming of moisture resistant boards and some very smooth backgrounds such as cast in-situ concrete
 - For the best quality plasterboard finishing, use Thistle Bonding Coat (5 - 8mm) with a 2mm application of Thistle Multi-Finish - see **Section 9 – Plaster systems**
- Sequence the work - approximate setting time is 90 minutes, but finishing times can be extended in low temperatures by 30 minutes or more
- Check use-by dates and use oldest material first
- Ensure environmental factors are suitable:
 - Plaster should not be applied to frozen backgrounds
 - When using Thistle Durafinish, ambient and background temperature must be maintained above 5°C until fully dry to obtain the full damage resistance
 - In very hot / dry conditions take precautions to avoid rapid loss of water
 - Finished plasterwork is suitable for locations where the temperature does not exceed 49°C
 - Avoid excessively polishing the surface

Installation



Mixing

- The plasters are pre-mixed. Add only clean water prepare them for use. **Do not** use any additives.
- Thistle plasters should be mixed by adding to clean water in clean mixing equipment. Contamination from previous mixes adversely affects the setting time and strength. Fresh contamination has more effect than old, so equipment should be washed just after mixing.



- Thistle plasters (except Thistle Projection) are suitable for mixing by hand or mechanical whisk of a slow speed, high torque type. A range of suitable mixers and paddles is available in the Gyproc Tools range. While mechanical mixing speeds the process up, there is no need to continue mixing after dispersing lumps and achieving the right consistency – over-mixing wastes time and energy, can affect setting times, lead to deterioration in workability and create difficulty in achieving a flat finish.



Application to board backgrounds

- Thistle Thin-Coat Angle Bead or Thistle Thin-Coat Mini Mesh Bead is fixed to the plasterboard angle by embedding in the finish plaster. Before this plaster sets, any surplus should be wiped from the corner, as scraping it away later may damage the zinc coating. If the bead is fixed to the board 'dry' the adhesion may be reduced because it is difficult to squeeze plaster between the bead and the plasterboard.

Reinforcing joints with Gyproc Joint Tape

- Pre-fill any gaps between boards exceeding 3mm.



● Reinforce joints and internal angles using Gyproc Joint Tape. Spread plaster along each joint, press Gyproc Joint Tape firmly into the plaster and immediately cover with a further application.

NB Leave sufficient plaster under the tape to ensure good adhesion and ensure that the joint treatment is free from air bubbles.

NB Crease Gyproc Joint Tape along centre line before application to internal corners.



Reinforcing joints with Thistle ProTape

● If preferred, flat joints can be reinforced with Thistle ProTape FT100 or Thistle ProTape FT50 glass fibre mesh tape.

NB Glass fibre mesh tape is not a direct substitute for Gyproc Joint Tape in resistance to cracking, particularly in systems where the board edges are not fully supported. Since Thistle ProTape FT50 is self-adhesive, pre-filling is not normally required.



- Position the tape and spread plaster along each joint. To minimise the risk of cracking, it is important to ensure that plaster is pushed through the tape well into any gap between boards.



- Apply plaster to board surface and joints with firm pressure after the joint treatment has stiffened but not set. Build out to 2mm thickness in two applications, wet-on-wet and trowel to a smooth matt finish. Use water sparingly and only in the latter stages of trowelling.

NB Guidance on good site practice is given in *EN13914-2 Design Considerations and Essential Principles for Internal Plastering*.



Decoration

- Ensure that the plasterwork is thoroughly dry before final decorating.
 - A coat of permeable paint can be applied in the interim.
 - Plaster surfaces can be decorated with most proprietary paint finishes and will accept the majority of wall covering adhesives. For guidance on tiling, see 10 – Tiling.
- NB** Always follow the manufacturers' recommendations in respect of applied decorative treatments.

Jointing

Gyproc jointing materials produce a smooth, continuous, crack-resistant lining surface ready for priming and final decoration. A number of jointing specifications are available to suit the board type, site preference and method of application - manually using hand tools or mechanically using Gyproc Speed Tape tools. After joint treatment has dried, the complete lining surface is treated with Gyproc Drywall Primer to prepare it for application of paint. Gyproc Drywall Sealer can be used in one coat to allow steam stripping of wall coverings, or in two coats to provide water vapour control.



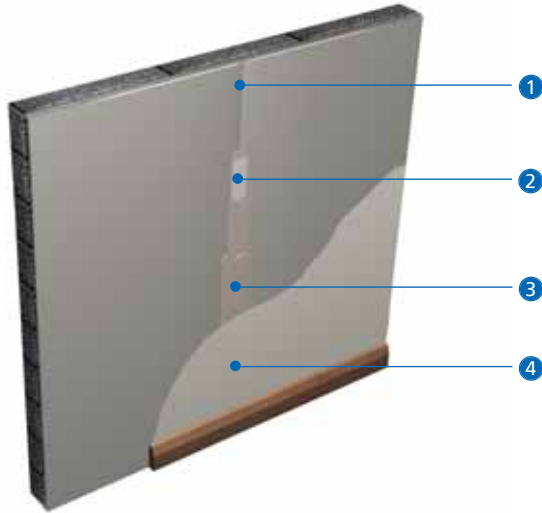

- 1 Tapered edge plasterboard
- 2 Gyproc Joint Tape
- 3 Gyproc jointing materials
- 4 Gyproc Drywall Primer or Gyproc Sealer

Key facts





- Produces seamless surface ready for decoration
- Choice of jointing materials to suit user preference
- Mechanically applied materials ideal for larger areas
- Ready-mixed or dry powder options
- ConstructionSkills grant-approved training

Components

Fixing and finishing products

		Quantities ¹ per 100m ²
	Gyproc Joint Filler For seamless plasterboard joints and angles. Bag weight 12.5kg	25kg Finishing coat
	Gyproc Joint Cement For seamless plasterboard joints and angles. Bag weight 22.5kg	12kg All coats 35kg
	Gyproc Ready Mix Joint Cement For seamless plasterboard joints and angles. Tub contents 12 litre	2.5 - 3 tubs
	Gyproc Promix Lite Joint Cement For seamless plasterboard joints and angles. Tub contents 17 litre	2 tubs
	Gyproc Easi-Fill For seamless plasterboard joints and angles. Bag weight 10kg	25kg
	Gyproc Easi-Fill 45 For seamless plasterboard joints and angles. Bag weight 10kg	25kg

Fixing and finishing products

		Quantities ¹ per 100m ²
	Gyproc Joint Tape For reinforcing plasterboard joints and internal angles. Roll length 150m	150 m
	Gyproc Corner Tape For reinforcing external, inc. splayed, angles. Roll length 33m	as required
	Thistle ProTape FT50 For reinforcing plasterboard joints. Dimensions 50mm x 90m	150 m
	Thistle ProTape FT100 For reinforcing internal angle joints. Dimensions 100mm x 45m	as required
	Gyproc Drywall Metal Angle Bead For external angle reinforcement. Length 3000mm	as required

¹ Quantities are approximate and for guidance only, no allowance has been made for waste.

Fixing and finishing products	Quantities ¹
 <p>Gyproc Drywall Archbead For arch reinforcement. Length 3000mm</p>	as required
 <p>Gyproc Drywall Metal Edge Bead Forms a defined edge to plasterboard areas. Length 2400 or 3000mm</p>	as required
 <p>Gyproc Drywall Plastic Edge Bead Forms a defined edge to plasterboard areas. Dimensions 12.5 x 3000mm</p>	as required
 <p>Gyproc No-Coat Ultraflex 325 Impact-resistant joint reinforcement, with a hinged co-polymer core to fit ant internal or external angle joint. Length 30m roll</p>	as required
 <p>Gyproc Control Joint For providing an allowance for movement up to 7mm. Length 3048mm</p>	as required

Fixing and finishing products	Width	Depth	Quantities ¹
 <p>BGM105 Edge Reveal</p>	25mm	10mm	as required
 <p>BGM106 Edge Reveal</p>	12.5mm	10mm	
 <p>BGM119 Edge Stop</p>	–	12.5mm	
 <p>Gyproc Drywall Primer Used to prepare for painting. Tub contents 10 litre</p>			110m ² per tub
<p>or</p>  <p>Gyproc Drywall Sealer Used to provide vapour control. Tub contents 10 litre</p>			110m ² per tub (1 coat) 70m ² per tub (2 coats)
 <p>Gyproc drywall tools A range of hand tools and Gyproc Speed Tape mechanical jointing tools and equipment.</p>			as required

Table 1 - Combinations and average coverage data (kg / 100 linear metre of joint)					
Jointing system	Reinforcement	Taping coat	1st finish coat	2nd finish coat	3rd finish coat
Flat joint (tapered edge - hand applied)	Paper tape / fibre tape	12	6	6	-
		12	6	6	-
		12	6	6	-
		9	5	-	-
Flat joint (tapered edge - mechanical)	Paper tape	6	6	6	3
Flat joint (square edge)	Paper tape	3	12	-	-
External angle	Corner tape	22	9	9	-
		22	9	9	-
		18	9	-	-
	Metal bead	34	9	9	-
		34	9	9	-
		28	12	-	-
Internal angle	Paper tape	12	8	8	-
		12	8	8	-
		12	8	8	-
		10	5	-	-

Notes to Table 1

These quantities should be used as a guide only - quantities used will vary depending on tools used and accuracy of board alignment.

Material used for pre-filling gaps, repairing damage, screw-spotting, etc is not included.

When using a ready mix joint cement in place of powder, assume 1 litre is equivalent to 0.85kg of powder joint cement.

An allowance for waste and material sanded away should be added as appropriate.

External angle reinforcements should be fixed using a setting product - Gyproc Joint Filler or Gyproc Easi-Fill / Easi-Fill 45, except Glasroc MultiBoard and Glasroc FireCase s (see 'Jointing Glasroc FireCase s and Glasroc MultiBoard', later).

KEY: Gyproc Joint Filler

Gyproc Joint Cement

Gyproc Easi-Fill / Easi-Fill 45

Table 2 – Joint reinforcement

	Flat joints	Internal angles	External angles	Splayed angles
Gyproc Joint Tape	✓	✓		
Thistle ProTape FT50	✓			
Thistle ProTape FT100		✓		
Gyproc Corner Tape			✓	✓
Gyproc Angle Bead			✓	
No-Coat Ultraflex 325		✓	✓	✓

Construction tips

- Ensure that boards are securely fixed with no steps between adjacent boards. The correct fixings must be used and properly located
- Drive home any protruding screw heads using a hand screwdriver prior to spotting and jointing
- Ensure site conditions are suitable: jointing materials must not be used at, or subjected to, temperatures below the minimum specified on packaging during application, setting or hardening
- Pre-fill gaps between boards greater than 3mm, prior to taping with Gyproc Joint Tape
- Select the right jointing material(s) (see **Table 1**). Note that Gyproc Easi-Fill 45 is only suitable for hand application
- Choose between hand or mechanical application
- Choose joint reinforcement method (see **Table 2**)
- To achieve a smooth continuous crack-resistant surface, use of tapered edge plasterboard and Gyproc Joint Tape is widely regarded as best practice

Installation – Hand

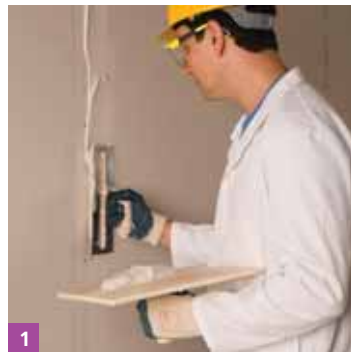

Hand jointing

- Bed Gyproc Joint Tape firmly into the appropriate grade of Gyproc jointing compound.

NB If Thistle ProTape FT50 is used, bedding is not required but the filling material should be pressed through the holes in the tape, particularly if there is a gap between the board joints. This is important to achieve a satisfactory appearance to the finished joint.

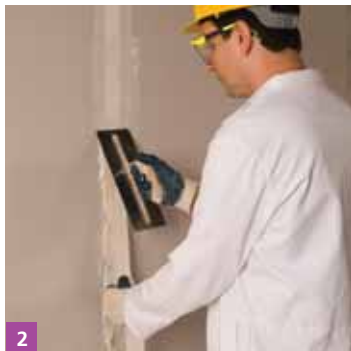

- Trowel apply two or three applications of jointing compound, allowing each to set or dry before the next application, feathering each out beyond the previous application.
- Make an equal number of applications to screw / nail spots.
- Sand each joint application as required to achieve a smooth surface.

NB Setting materials (e.g. Gyproc Joint Filler, Gyproc Easi-Fill) can be overcoated when set but not dry. Air-drying materials (joint cements) must be dry before overcoating.



NB At board joints, where cut edges or square edge boards occur, the joint treatment is inevitably raised above the board surface and is more difficult to conceal. In this situation the secondary filling stage is omitted, and joint treatment is feathered out further in order to conceal the joint.



- At internal angles, crease Gyproc Joint Tape to the angle to provide reinforcement and bed firmly into jointing material using a tapping knife and feather out.
- Allow jointing material to dry then lightly sand, if required, to remove any minor imperfections.
- Apply final coat of jointing material and feather out beyond previous application.
- Allow to dry, then lightly sand.



5

- At external angles use Gyproc Corner Tape or Gyproc No-Coat Ultraflex 325, or where additional protection is required, use a Gyproc angle bead instead.

- Use a Gyproc edge bead to protect cut ends of boards (e.g. at abutments).

NB Use a setting compound (Gyproc Joint Filler or Gyproc Easi-Fill) except Glasroc FireCase s and Glasroc MultiBoard, see later.



6

- Apply Gyproc Drywall Primer or Gyproc Drywall Sealer to the entire board surface and jointed areas to prepare the lining for final decorative treatment.

NB Remove any surface dust and ensure background is dry prior to application.

Installation – Mechanical

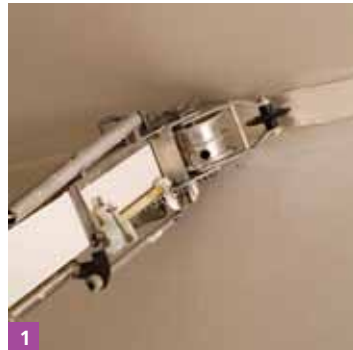

1

Mechanical jointing

- Gyproc Speed Tape tools can be used as an alternative to hand jointing, to provide a fast, consistent finish using 175mm, 250mm and 300mm boxes as appropriate.



● A full range of tools and ConstructionSkills approved training are available:-

For Gyproc Tools, contact BPB Artex, Tel: 0800 032 6345.

For training enquiries, contact the British Gypsum Drywall Academy Training Centre Tel: 0844 561 8810.



Joining Glasroc FireCase s and Glasroc MultiBoard

- Trowel apply Gyproc Joint Cement to the joint and bed in Gyproc Joint Tape.
- Alternatively, for flat joints, apply Thistle ProTape FT50 over the joint and trowel apply a coat of Gyproc Joint Cement.
- Allow to dry and lightly sand if required, to remove any high spots.
- Trowel apply a second coat of Gyproc Joint Cement and feather-out to about 200mm width on each side of the joint.

- Allow to dry and lightly sand.
 - A third application of Gyproc Joint Cement may be necessary, applied as for the second and slightly wider, for example if the boards were fixed with any steps, gaps or minor damage.
 - Use Gyproc Joint Tape at internal corners and Gyproc Corner Tape at external corners.
- NB** For the **FireCase** system, external angles / corners can be reinforced using Gyproc No-Coat Ultraflex 325 bedded in Gyproc Joint Cement.



- Across the width of the board, bed Gyproc Joint Tape firmly into Gyproc Easi-Fill and bulk fill the taper edge joints.



- When set, apply a finish coat of Gyproc Easi-Fill to all joints.
- Take care not to fill the perforations in the board and thereby impair the sound absorption performance.
- Lightly sand and dust-off.
- Apply Gyproc Drywall Primer to the entire surface ready for decoration, using a brush or roller. Boards should not be spray painted as this affects sound absorption performance.

Jointing Arteco Gyptone boards

- Arteco Gyptone boards are supplied with all four edges tapered to allow for true flat joints to be created at each board interface, to give a perfectly flat finished ceiling.
- Along the board length, bed Gyproc Joint Tape firmly into Gyproc Easi-Fill and bulk fill the taper edge joints.

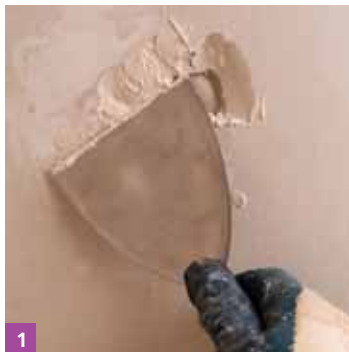

Cleaning equipment

- Clean all equipment thoroughly after use. Small residual amounts of set or part-set material can accelerate the set of freshly mixed jointing compound.

Maintenance and repair of plasterboard

- British Gypsum linings and membranes are essentially non-demountable. No special maintenance is required other than a normal surface decoration regime.

Minor damage

- Lightly sand the surface to remove any burrs and fill flush with Gyproc Easi-Fill or two applications of Gyproc Joint Cement.
- When dry, apply Gyproc Drywall Primer or Gyproc Drywall Sealer to leave the surface ready for decoration.

Deep indents resulting from impact

- Check the plasterboard core to ensure that it is not shattered. Carry out this check even if the paper is not fractured.
- If intact, repair the damaged area as for minor damage, but firstly apply a coat of Gyproc Joint Filler or Gyproc Easi-Fill, followed by Gyproc Joint Cement or Gyproc Easi-Fill once set/dry.



1

Damaged core/broken edges

- Remove the damaged area of core.
- Lightly score the liner approximately 10mm away from the damaged area, and peel the paper surface away.
- Apply Thistle GypPrime or PVA to seal the core and surrounding liner.
- Bulk fill the hole with a stiff mix of Gyproc Easi-Fill or Gyproc Joint Filler, and strike off flush.

- Apply Gyproc Easi-Fill, or two applications of Gyproc Joint Cement once the filler is set/dry.
- When dry, apply Gyproc Drywall Primer or Gyproc Drywall Sealer.

Extensive damage to linings and membrane

When the damage is more extensive it may be necessary to replace that area of plasterboard. It is important that the replacement board is of the same type as specified and installed.



2

- Cut out the affected area back to the nearest framing member.
- Fix additional framing member as necessary to ensure all joints are fully supported.



- Replace the plasterboard, accurately cutting and screw-fixing the same type and thickness of plasterboard.
- Fill edge joints, then tape and finish in the recommended manner.
- Treat the finished surface with Gyproc Drywall Primer, or two coats of Gyproc Drywall Sealer where previously specified for vapour control purposes.
- Redecorate as required.

Damage to framing

● Where damage has occurred to metal framing, it will need to be replaced as per the system specification prior to re-boarding.

Decoration

● After the joint treatment has set and dried, and any final sanding is complete, dust down the surface and apply Gyproc Drywall Primer to even out differences in surface texture and absorption between the board and jointed areas to create the ideal surface to receive final decoration.

Early application of Gyproc Drywall Primer helps to prevent plasterboards from yellowing. It is easily applied by brush or roller.

● Where water vapour control is a requirement, apply two coats of Gyproc Drywall Sealer to the plasterboard surface.

● Apply decoration with the minimum of delay after Gyproc Drywall Primer or Gyproc Drywall Sealer has dried.

NB If Gyproc Drywall Sealer is applied in a single coat, steam stripping at a later date becomes a simple operation.

! Gyproc Drywall Primer or Gyproc Drywall Sealer are not suitable for application to Glasroc MultiBoard or Glasroc FireCase s. Both these boards are suitable to receive direct decoration applied in accordance with the manufacturers' recommendations.

NB As with all wall and ceiling areas, gloss high sheen finishes will highlight variations of the surface, particularly with shallow angle lighting. The use of low sheen or matt finishes minimises this risk. Jointing should be carried out under similar lighting conditions to those used for subsequent inspection and use.

Heavy, semi-rigid or impermeable wallcoverings

● The use of these wallcoverings may involve specialist adhesives or techniques which may not be compatible with Gyproc Drywall Primer or Gyproc Drywall Sealer. Consult the wallcovering and/or adhesive manufacturer for a specific recommendation.

! Impermeable wallcoverings fixed with water-based adhesives should **not** be applied over Gyproc Drywall Sealer, as the drying of the adhesive will be severely restricted.

Tiling

In rooms subject to high or intermittent moisture conditions, the range of boards available for tiling offers flexibility of design and peace of mind when installed in both wall linings and lightweight partition systems.

Specifically designed for direct tiling applications, Glasroc H TILEBACKER is the ideal substrate for tiling in environments subjected to moisture, providing protection for shower enclosures, bathrooms, swimming pool halls[†] and adjacent areas.

For areas where intermittent moisture conditions are more common, including kitchens and bathrooms, Gyproc moisture resistant grade boards are suitable.



[†] In conjunction with a suitable tanking system.



Key facts

- Glasroc H TILEBACKER has been designed for use in high moisture applications
- Glasroc H TILEBACKER will hold tiling systems up to 32kg/m² on walls and 50kg/m² on floors
- Gyproc moisture resistant grade boards are suitable for use in low moisture applications
- Glasroc H TILEBACKER and Gyproc moisture resistant grade boards can be installed using the GypWall CLASSIC² and timber stud partitioning systems, as well as the DriLyner, DriLyner MF, GypLyner UNIVERSAL and GypLyner IWL wall lining systems

² Guidance refers to GypWall CLASSIC using 70mm Gypframe stud, but other GypWall systems can be used.

Components

Boards for high moisture conditions



Glasroc H TILEBACKER²

Thickness	6, 12.5mm
Width	1200mm

Take-off quantities¹

100m²
per outer layer

Boards for intermittent moisture conditions



Gyproc Moisture Resistant³

Thickness	12.5, 15mm
Width	1200mm

100m²
per layer



Gyproc FireLine MR³

Thickness	12.5, 15mm
Width	1200mm

100m²
per layer



Gyproc SoundBloc MR³

Thickness	12.5, 15mm
Width	1200mm

100m²
per layer



Gyproc SoundBloc RAPID MR³

Thickness	15mm
Width	900mm

100m²
per layer

Boards for intermittent moisture conditions



Gyproc DuraLine MR³

Thickness	15mm
Width	1200mm

Take-off quantities¹

100m²
per layer



Glasroc F MULTIBOARD

Thickness	6, 10, 12.5mm
Width	1200mm

100m²
per layer



Glasroc F FIRECASE

Thickness	15, 20, 25, 30mm
Width	600, 1200mm

100m²
per layer



Rigidur H

Thickness	12.5, 15mm
Width	1200mm

100m²
per layer

¹ Quantities are for 100m² of straight wall lining with single layer boarding or for 100m² of floor lining. Quantities are approximate and for guidance only. No allowance has been made for waste, openings, abutments, etc. Refer to **SITE BOOK** section 12 - Quantity take-off details.

² Glasroc H TILEBACKER is suitable for use in high moisture environments.

³ Moisture resistant boards are specified in intermittent wet use areas.

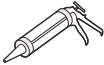
Fixing and finishing products		Take-off quantities ¹
	<p>Gyproc Nailable Plugs</p> <p>Diameter 6mm</p> <p>Length Minimum 60mm</p>	dependent on board
	<p>Waterproof tile adhesive (by others)</p>	as required
	<p>Tiles (by others)</p> <p>Weight 32kg/m² (maximum including adhesive and grout)</p>	as required
	<p>Waterproof sealant (by others)</p>	as required

Construction tips - General

- During installation all boards should be lifted short of the floor
- It is good practice to protect the cut ends of Gyproframe metal components to prevent corrosion
- For **DriLyner** systems, wall linings should be left to stand for seven days before tiling
- On **DriLyner BASIC, TL** and **SI**, horizontal dabs of Gyproc Dri-Wall Adhesive are required at mid-storey height
- When using **DriLyner MF**, Gypframe MF10 channels should be located at 400mm centres and board should be screw fixed at 300mm centres into each channel

Construction tips - General (cont'd)

- **DriLyner TL** and **RF** (except Gyproc TriLine) require nine Gyproc Nailable Plugs to provide a secondary mechanical fixing
- When installing **DriLyner SI** with Gyproc TriLine, Gyproc Nailable Plugs are required at 600mm centres vertically, 15mm in from each edge
- **GypLyner IWL** requires support centres at 400mm, with mid-height support from framework to structure
- **GypLyner UNIVERSAL** requires support centres at 400mm with fixing brackets at 600mm centres
- For timber stud partitions, studs should be installed at 400mm centres for 12.5mm boards, and 600mm centres for 15mm boards. Additional supports are required vertically at 600mm centres
- For timber batten wall linings, battens should be installed at 400mm centres, with noggings at 1200mm vertical centres

Construction tips - Glasroc H TILEBACKER

- In extreme moisture environments, the exposed surfaces of Glasroc H TILEBACKER should be treated with a suitable tanking system. Gyproc moisture resistant boards are not recommended for high or extreme moisture environments
- When installing the **GypWall CLASSIC** system using 12.5mm, studs can be located at 600mm centres. For 6mm (e.g. **GypWall CURVE**) studs must be at maximum 300mm centres
- For **DriLyner BASIC** and **RF** systems, nine Gyproc Nailable Plugs are required to provide a secondary mechanical fixing - with the exception of 900mm x 1200mm boards, which require three

Table 1 – Board lining requirements

Level of moisture	Typical application	Board
Low	Residential Splash backs Kitchens Toilets	Gyproc Moisture Resistant and MR variants
Medium	Residential Kitchens Bathrooms	Gyproc Moisture Resistant and MR variants OR Glasroc H TILEBACKER
High	Residential Shower enclosure walls Commercial Kitchens Changing rooms	Glasroc H TILEBACKER
Extreme	Commercial Communal shower walls Swimming pool hall walls	Glasroc H TILEBACKER ¹

¹ In extreme moisture environments, the exposed surfaces of Glasroc H TILEBACKER should be treated with a suitable tanking system.

Installation – single layer partition



GypWall CLASSIC

● The following guidance is based on GypWall CLASSIC using 70mm Gypframe stud and relates to the installation of Glasroc H TILEBACKER and Gyproc moisture resistant grade plasterboards. Additional installation procedures may need to be followed for other stud specifications and performance related constructions.

- Determine and mark the wall position, making allowances for any openings.
- Fix Gypframe Floor & Ceiling Channels to both the floor and ceiling at 600mm centres with suitable fixings.



- Cut studs to a neat fit (maximum possible entry into head and base channel). The engagement should be a minimum of 20mm, allowing for any deflection where required.

NB Cut studs to size using a chop saw, hacksaw or snips.



- Locate the first stud, twist into position and fix to the abutting wall at 600mm centres.



- Locate further studs at 600mm centres for 12.5mm Glasroc H TILEBACKER, or at 400mm centres for any 15mm Gyproc moisture resistant grade plasterboard.

NB Where 146mm studs are used, Gyproc moisture resistant grade plasterboards can be installed with Gypframe metal studs at 600mm centres. Additional studs are required at 300mm centres to the tiling height.



- When medium weight fixtures will be installed, for example a shower unit, install Gypframe 99 FC 50 Fixing Channel to accommodate the fixture.

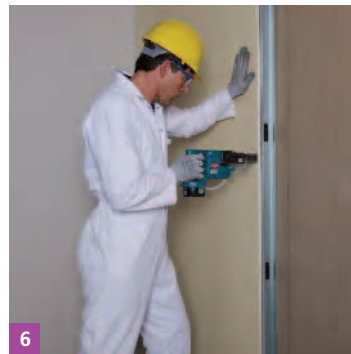

- Fix 12.5mm Glasroc H TILEBACKER or Gyproc moisture resistant grade plasterboard to all framing members at 300mm centres, using the appropriate length British Gypsum Drywall Screw, to give a minimum 10mm penetration into the stud.

- Reduce centres to 200mm at external angles.

NB When installing Glasroc H TILEBACKER, boards must be installed with the yellow face exposed. The pre-primed yellow acrylic face of the board has been

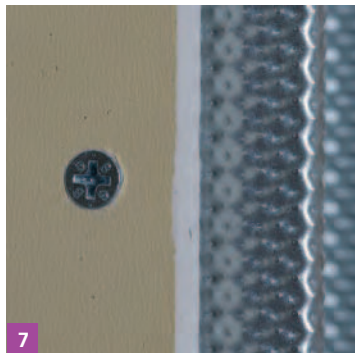

- Lightly butt boards, inserting screws not closer than 10mm from the edge of the board (13mm from site cut edges).
- Care should be taken not to over tighten screws.
- Boards are now ready for application of tiles, see **Tiling installation** guidance at the end of this section.
- For full installation details of GypWall CLASSIC, including components and detailing, refer to the GypWall CLASSIC section of the British Gypsum **SITE BOOK**.



Timber stud

- If installing timber stud framework, ensure studs are installed at 400mm centres. For 6mm, studs must be at maximum 300mm centres.
- Additional support centres (battens) are also required at head, base and intermediate positions, not exceeding 1200mm centres.
- Install using British Gypsum Drywall Timber Screws at appropriate lengths to give a nominal 25mm penetration into the timber.
- Install at 300mm centres (maximum 200mm at external angles).
- Lightly butt boards, inserting screws not closer than 10mm from the board edge (13mm from site cut edge)



DriLyner BASIC system

- The following guidance is for DriLyner BASIC, other DriLyner systems can be used. Refer to **Construction tips** on pages 4-6.
- 12.5mm Glasroc H TILEBACKER and Gyproc moisture resistant grade plasterboards can be installed using the DriLyner BASIC wall lining system.

- Determine high spots on the wall and plumb position to the ceiling and floor.
- Transfer this dimension to the room corners, add an allowance of 10mm plus the board thickness, then strike continuous chalk lines on the floor and ceiling.
- Mark the wall with lines at 1200mm centres to indicate board positioning (1200mm wide boards).

- Trowel apply a continuous band of Gyproc Dri-Wall Adhesive to the perimeter of the wall, services and openings for optimum airtightness.
- Commence the drylining from a window / door reveal or internal angle.
- Trowel apply adhesive to form dabs 50mm to 75mm wide and about 250mm long.



- Position dabs of Gyproc Dri-Wall Adhesive in three vertical rows to receive the first board.
- Ensure the dabs are adjacent to a board joint and are approximately 25mm in from the edge to avoid bridging the joint.
- Apply intermediate dabs at ceiling level.



- Apply a continuous band of Gyproc Dri-Wall Adhesive at skirting level.



- Apply horizontal dabs of Gyproc Dri-Wall Adhesive at mid board height to support tile loading.
- NB** Consider using additional dabs of adhesive where fixtures are required, for example a shower unit, to provide extra support.



6

- Cut 12.5mm Glasroc H TILEBACKER or Gyproc moisture resistant grade plasterboards 15mm short of the floor to ceiling height.
- Position the first board, yellow face exposed, with the bottom edge resting on board packing strips.

NB When installing Glasroc H TILEBACKER, boards must be installed with the yellow face exposed. The pre-primed yellow acrylic face of the board has been designed to directly receive the tiling system.



7

- Tap the board back firmly using a straight-edge until it aligns with the ceiling and floor chalk lines.



8

- Gently lift using a footlifter until the board is tight against the ceiling.
- Insert additional packing strips at the base to wedge the board in place and remove the footlifter.
- Apply dabs for the next board and continue drylining with boards lightly butted.



- When dabs have set, install nine Gyproc Nailable Plugs to provide a secondary mechanical fixing.
 - Insert a row of three plugs at top, bottom and mid-height, with outer fixings 15mm from each edge, and the middle position fixed centrally (600mm).
- NB** For 900mm x 1200mm boards, install one row of three Gyproc Nailable Plugs at mid-height (450mm).

- Boards are now ready for application of tiles, see **Tiling installation** guidance at the end of this section.
- For full installation details, refer to the DriLyner **BASIC** section of the British Gypsum **SITE BOOK**.



GypLyner **UNIVERSAL** system

- 12.5mm Glasroc H **TILEBACKER** and Gyproc moisture resistant grade plasterboards can be installed using the GypLyner **UNIVERSAL** wall lining system.
- Use a straight edge (e.g. Gypframe GL1 Lining Channel) to determine the maximum undulation in the wall or service protrusion. This will determine the cavity depth.



- Mark chalk lines to the floor and ceiling to indicate the positioning of the Gypframe GL8 Track.



- Fix Gypframe GL8 Track to perimeters, with the longer leg towards the lining, at 600mm centres using the appropriate fixing.



- Mark vertical lines on the wall at 400mm intervals to indicate bracket fixing centres.
- Mark horizontal lines at 600mm centres to determine individual bracket position.
- Use a 5.5mm drill bit to drill a 45mm minimum depth hole.
- Position each bracket, ribs to the wall, and fix through bracket slot into the masonry wall using a Gypframe GL11 GypLyner Anchor, which is a hammer fixing.



- Cut GL1 Lining Channels to size and round-off ends with tin snips for an easier fit.
- Friction fit Gypframe GL1 Lining Channel into the track.



- Bend bracket legs forward and fix each leg to the channel using a British Gypsum Wafer Head Drywall Screw. Insert screw through the hole in the bracket nearest to the back of the channel.

NB Avoid exerting any backwards or forwards pressure on the channels when screw-fixing the brackets, otherwise a straight and true lining surface may not be achieved.



- Bend back protruding bracket legs to sit clear of the channel face.
- Friction fit remaining Gypframe GL1 Lining Channels into the track at 400mm centres.



Internal angles

- Position a Gypframe GL1 Lining Channel tight into the corner in order to provide support for the lining.
- Bend one bracket leg across the face of the Gypframe GL1 Lining Channel and fix with a British Gypsum Wafer Head Drywall Screw to secure and restrain the channel at the corner position.

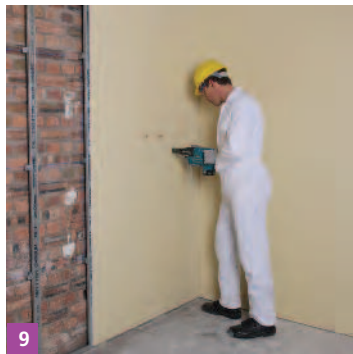

- Fix boards to framing members at 300mm centres using British Gypsum Drywall Screws, to give a minimum 10mm penetration into the channel.
 - Reduce centres to 200mm at external angles.
 - Lightly butt boards, inserting screws no closer than 10mm from the board edge (13mm from site cut edge).
- Boards are now ready for application of tiles, see **Tiling installation** guidance at the end of this section.
 - For full installation details of GypLyner UNIVERSAL, including components and detailing, refer to the GypLyner UNIVERSAL section of the British Gypsum **SITE BOOK**.



GypLyner iWL system

- 12.5mm Glasroc H TILEBACKER and Gyproc moisture resistant grade plasterboards can be installed using the GypLyner iWL wall lining system.
- Mark lines to indicate the position of the lining framework from the highest point on the background.



- Locate Gypframe Floor & Ceiling Channel up to the floor and ceiling lines.
- Fix Gypframe 'C' Studs to abutments, junctions and openings only.



- Position the Gypframe 'I' Studs vertically between channel sections and twist to locate.
- Install at 400mm centres.



- Fix boards to framing members at 300mm centres using the appropriate length British Gypsum screws, to give a minimum 10mm penetration into the stud.
- Reduce centres to 200mm at external angles.

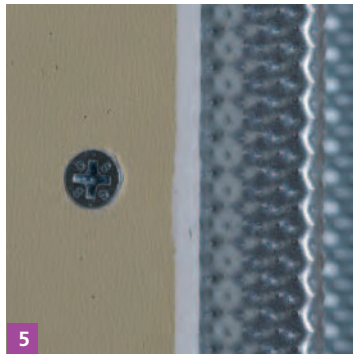

- Lightly butt boards, inserting screws not closer than 10mm from board edges (13mm from site cut edge).
- Care should be taken not to over tighten screws.
- Boards are now ready for application of tiles, see **Tiling installation** guidance at the end of this section.
- For full installation details of GypLyner iWL, including components and detailing, refer to the GypLyner iWL section of the British Gypsum **SITE BOOK**.

Installation - Timber floor

On existing timber floors ensure

- Floor is structurally sound.
- Screws used to fix the board do not penetrate into the floor cavity.
- Floor is clean and as even as possible.
- The floor is not subject to excessive movement or flexing as this could cause tiled floor to crack.



- Ensure floor surface is clean
- Place a bed of tile adhesive directly onto the floor surface.
- Bed the board into the tile adhesive to create a level surface. Make sure the yellow pre-primed finish faces outwards for tiling



- Fix the boards to the timber sub floor using British Gypsum Drywall or Drywall Timber screws at 200mm centres. The length of fixing used should be selected to avoid penetrating through the floor surface into the cavity to prevent damage to any services that may be within the floor.
- Board joints can be reinforced with 50mm Thistle ProTape bedded into the joint using tile adhesive.

Curved Partitions



For full installation details on GypWall CURVE system please refer to Section 5 SITE BOOK

- 6mm Glasroc H TILEBACKER can be curved to 600mm radius, for ease of fixing where possible use 2400mm long boards. Fix the boards horizontally. Stagger the board joints and avoid joints occurring on the apex of a convex curve.
- For tight radius partitions the ease of installation can be improved by pre-bending the board.



- Fix the board using British Gypsum Drywall Screws at 300mm centres in the field of the board and 150mm centres at the board ends.

Board joints should be reinforced with 50mm Thistle ProTape bedded into the joint using tile adhesive.

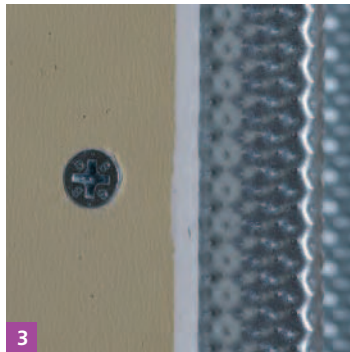

- Lightly butt boards, inserting screws not closer than 10mm from board edges (13mm from site cut edge).
- Boards are now ready for application of tiles, see **Tiling installation** guidance at the end of this section.
- For full installation details of GypLyner iWL, including components and detailing, refer to the GypLyner iWL section of the British Gypsum **SITE BOOK**.

Tiling Installation

Using Glasroc H TILEBACKER

- Once Glasroc H TILEBACKER boards are installed, use the following guidance, in conjunction with tile system manufacturers' guidance, to ensure the system is appropriately sealed for its use.
- Where Gyproc Dri-Wall Adhesive has been used to install the boards in either the DriLyner BASIC and DriLyner MF systems, ensure the adhesive has fully set before tiling.
- A tanking system is recommended in extreme moisture conditions, e.g. swimming pool halls and communal showers.



- 1**
- Ensure the boards are dust free prior to installation of the tiling system.



- 2**
- The perimeter of the wall, e.g. base, head and wall abutments, should be sealed with a silicone-based sealant.

- Ensure all board joints within the tiling area are covered with a waterproof tile adhesive and all board perimeter junctions are sealed with a silicone-based sealant.



- Install tiles using a thin bed of adhesive, strictly following the manufacturers' recommendations. Ensure all screw heads are filled with adhesive.

NB The tiling system should weigh no more than 32kg/m² on walls and 50kg/m² on floors.

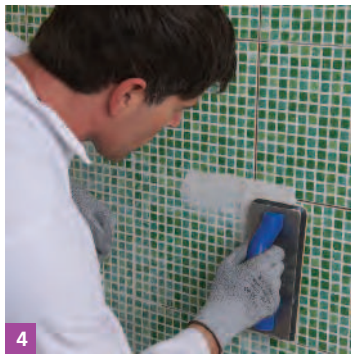

- Once set, ensure tiles are fully sealed using a waterproof grout.

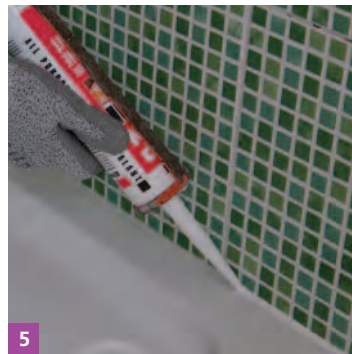

- All perimeters must be sealed using a waterproof silicone sealant.

NB Special attention should be paid to those areas between the wall and floor joints, the junction of the shower or bath base, pipes or services passing through the walls, any frames or apertures, and joints where movement may occur.



Skimmed plasterboard and plaster systems

- Where designs include part-tiled wall areas, e.g low moisture environments, the board can be either plaster skimmed or jointed above the line of the tiles, 6mm Glasroc H TILEBACKER applied to floors should be fully tiled.
- Thistle Board Finish, Thistle Multi-Finish and Thistle Durafinish can be used as a plaster, in conjunction with ThistleBond-it.
- Walls should be painted with an appropriate moisture-resistant paint.

- Install the tiling system using a thin bed of adhesive.
- Apply the adhesive strictly in accordance with the manufacturers' instructions except where the system includes a bonding agent. In this situation the total weight of tiles and plaster applied over a bonding agent is limited to 20kg/m², therefore consideration should be given to tiling directly to the background.

- It is not recommended to tile directly onto undercoat plaster.
- Ensure that plasterwork is thoroughly dry and stable.

NB Thistle Board Finish and Thistle Multi-Finish should not be over-trowelled to a polished surface, as reduced adhesion will result. Polished plasterwork should be roughened and a suitable primer used to consolidate the surface. Dusty surfaces and plaster surfaces should also be treated with a suitable primer prior to applying a cement-based tile adhesive.

Tiling onto jointed plasterboard

- Install the tiling system (up to 32kg/m²) using a thin bed of adhesive.
- Apply the adhesive strictly in accordance with the manufacturers' instructions

Tapered edge

- Plasterboard joints must be filled with tile adhesive as tiling proceeds.
- If conventional jointing has already been completed, joint treatment must be thoroughly dry, because tiles will trap in any residual moisture.
- Ensure that all dust from sanding is removed.

Decorative effects

A wide variety of decorative effects can be achieved using Gyproc accessories to enhance walls and ceilings, and to relieve flat runs of lining, joints and angles. The portfolio of decorative products comprises gypsum cove and cornice profiles and pre-formed, aluminium Gyproc Styletrims. Gyproc Cove and Cornice products relieve the plain, boxy look at internal ceiling angles to create a more pleasing internal environment. A number of design effects are possible by incorporating steps to the wall and ceiling angles, using Gyproc Cornice Battens and Strips.





Key facts

- Wide variety of attractive, drylined effects possible
- Cove / Cornice profiles and steps to enhance wall and ceiling angles
- Range of aluminium styletrims to relieve flat runs of lining, provide alternative to custom-made profiles

Components

Gyproc Cove and Cornice products

			Quantities
	Gyproc Cove 100 Length 3000mm Paper face White		as required
	Gyproc Cove 127 Length 3000, 3600, 4200mm Paper face Ivory		as required
	Gyproc Cornice 135 Length 3000mm Paper face White		as required
	Gyproc Cornice Battens 1200mm x 25mm x 10mm		as required
	Gyproc Cornice Strips 2400mm x 100mm x 10mm		as required

Gyproc Styletrims

			Quantities
	Gyproc BGM 105 Edge Reveal Used to create a reveal around drylined wall perimeters, doors, glazing and skirting. Reveal Width 25mm Reveal Depth 10mm		as required
	Gyproc BGM 106 Edge Reveal Used to create a reveal around drylined wall perimeters, doors, glazing and skirting. Reveal Width 12.5mm Reveal Depth 10mm		as required
	Gyproc BGM 119 Edge Stop Used to create a distinctive straight edge for reveals and other drylining features. Reveal Depth 12.5mm		as required

Fixing and finishing products	Take-off quantities
 <p>Gyproc Drywall Screws For pre-fixing Gyproc Styletrims.</p>	as required
 <p>Gyproc Jack-Point Screws For fixing boards to stud framing 0.8mm thick or greater and 'I' studs greater than 0.55mm thick.</p>	as required
 <p>Gyproc Sealant For sealing gaps and /or pre-fixing Gyproc Styletrims.</p>	1 cartridge per 35m based on a 6 -10mm bead
 <p>Gyproc jointing materials For bedding Gyproc Styletrims and subsequent joint treatment.</p>	as required

Fixing and finishing products	Take-off quantities
 <p>Gyproc Drywall Primer For priming Gyproc Cove and Cornice products and plasterboard linings as preparation for painting.</p>	as required
 <p>Gyproc Cove Adhesive For adhesive fixing of Gyproc Cove and Cornice products.</p>	1kg per 4m

Construction tips - Cove and Cornice

- Gyproc Cove and Cornice can be installed to clean, dry and sound backgrounds using Gyproc Cove Adhesive, which is also used to fill gaps and mitres
- Airtightness is essential for optimum sound and thermal insulation of plasterboard building elements. Gyproc Cove or Cornice helps achieve this while improving the appearance
- Where the wall or ceiling has severe irregularities or where the surface would not provide sufficient adhesion, Gyproc Cove or Cornice can be mechanically fixed

Installation



Installing Gyproc Cove and Cornice Preparation

- Remove any wallpaper from the walls and ceiling.
- Draw guidelines along the walls and ceiling, 67mm from the wall / ceiling angle for Gyproc Cove 100 and 83mm for Gyproc Cove 127.
- For Gyproc Cornice, draw a line on the ceiling 92mm from the angle and on the wall at 84mm from the angle.

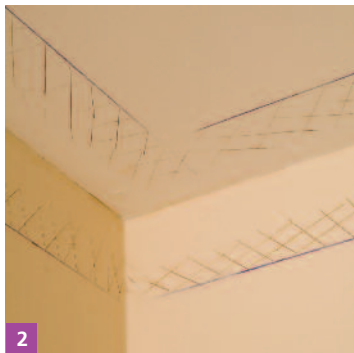

- Scratch plastered or painted areas which will be in contact with the profile to provide a key for the adhesive, and brush away any dust or loose material.



Cutting

- Cut the profile to length using a fine tooth saw.
- Mitre using a Gyproc Cove Mitre Box, Gyproc Magic Mitre, Gyproc Cove Mitre - Metal or other suitable mitre block, making saw cuts into the curve as required.



Applying adhesive

- Mix Gyproc Cove Adhesive with water as per the user guidance on the packaging.
 - Make the mix stiff enough to spread without running - too stiff and it will be difficult to apply, too thin and it will not bond properly.
- NB** As a rough guide, 1kg of Gyproc Cove Adhesive will fix about 4m of Gyproc Cove or Cornice and remains usable for at least 40 minutes. Avoid mixing more than can be used in this time. The adhesive will set hard in 90 - 120 minutes.

NB Keep tools and buckets clean and free from set adhesive. Damp down dry plaster or other high suction backgrounds immediately prior to applying the adhesive.



Fixing

- Lightly nail the wall line to provide temporary support to the profile until the adhesive has set. Use two nails for each piece.
- Offer up the profile and push it firmly into position between the guide lines.

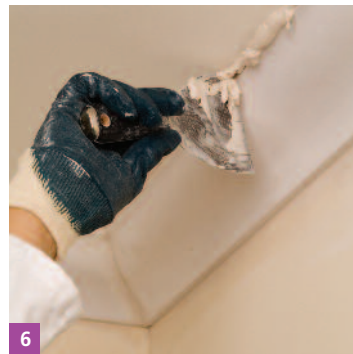

- Remove excess adhesive and use it to make good the mitres and any joints.
- To finish, moisten a paint brush and trace it along the junctions of the profile and background.



Stop ends

- Stop ends are required where openings extend to ceiling height. Measure out a length of profile for the run which abuts the wall opening or reveal, and cut the appropriate external mitre.
- Cut the corresponding mitre on a short surplus length and cut the length off square to leave a wedge shape which forms a perfectly fitting, mitred stop-end.
- Fix both lengths as normal (the longer one first) and make good the mitre with Gyproc Cove Adhesive as previous.

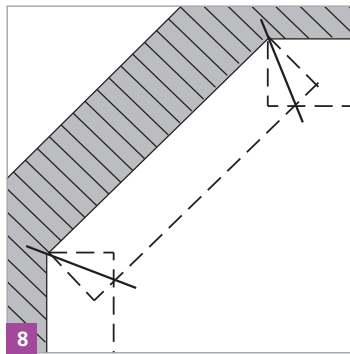

Mitring by the projections method

- Draw lines along the ceiling parallel to the walls and extend them to intersect as shown (refer to 'Preparation' earlier for dimension).
- Place suitably sized profile section with square ends in position and mark on its wall edge the point where the walls meet, and on the ceiling edge the point where the lines drawn intersect.
- Cut the profile along a line drawn between the two marks.

Finishing

- After making good, allow to dry thoroughly, then treat surfaces with Gyproc Drywall Primer, prior to applying the decorative paint finish.



Creating Steps

- For the desired profile, decide how many steps are required at the wall and ceiling positions and the step sizes.
- Work out the position of the Gyproc Cornice Strips and mark the ceiling and / or wall.
- Scratch plastered or painted areas which will be in contact with the profile to provide a key for the adhesive, and brush away any dust or loose material.

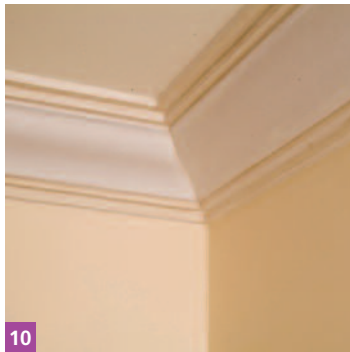

- Lightly nail the wall / ceiling to aid alignment and give temporary support while the adhesive sets. Use two nails for each strip.
 - Apply Gyproc Cove Adhesive, approximately 3mm thick, to each strip and comb out.
 - Position the strip against the background and tap back with straight edge.
 - Fix additional strips in the same manner. Make sure the adhesive has set thoroughly before starting the next stage.
 - Butt-joint Gyproc Cornice Strips together at angles.
- NB** When creating stopped ends with Gyproc Cornice Strips, note where the farthest piece finishes on the ceiling and mark back the projection to the projection on the wall line. Step back each strip to form the feature required as a stopped end.

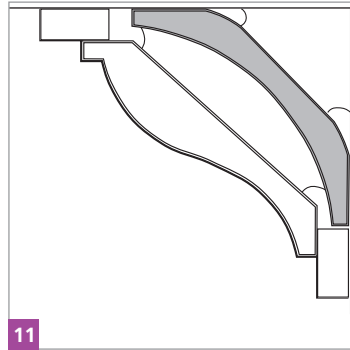

- Treat all exposed edges as necessary to control suction before making good the step joints.
- When dry, brush in adhesive to the small gaps at step edges. The steps are now ready to receive the Gyproc Cove or Cornice profile.

Covering existing mouldings

- Fix Gyproc Cornice Batts in the same manner as Gyproc Cornice Strips to allow the new profile to bridge over an existing old or damaged moulding without the need to remove it.

Construction tips - Styletrims

- Gyproc Styletrims can be used in conjunction with Gyproframe metal studs, metal furring channels, British Gypsum **GyLyner** systems, and timber framing
- Vertical runs of Gyproc Styletrim and all Gyproc Styletrim joints should be supported by framing members
- Gyproc Styletrims should be backed by plasterboard, avoiding direct contact with framing members
- If plasterboard is removed for installation of Gyproc Styletrims, fire resistance and sound insulation performances will be affected and an additional layer of plasterboard may need to be installed

Installation

Installing Gyproc Styletrims

Cutting

- Cut Gyproc Styletrims using a fixed power saw. Ensure accurate cutting in order to achieve neat butt joints and mitre joints.

Preparation and planning

- First install the framing and plasterboard linings.

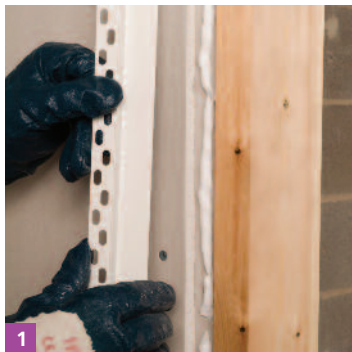

Sealant fixing

- Apply a 5mm bead of Gyproc Sealant to the lining surface which will be in contact with the solid surface(s) of the Gyproc Styletrim.
- Position the Gyproc Styletrim and press firmly into the sealant bead, working progressively along the length of the Gyproc Styletrim.

NB If sealant is applied to the edge of a board, this should be a bound edge. If a cut edge is unavoidable, pre-treatment with a suitable bonding agent may be necessary.

Mechanical fixing

- Where increased strength is required e.g. Gyproc Styletrim corners, mechanically pre-fix Gyproc Styletrim prior to joint treatment.
- Screw-fix the Gyproc Styletrim where it crosses support framing, at 600mm maximum centres, using Gyproc Drywall Screws (or Gyproc Jack-Point Screws if framework metal is 0.80mm thick or greater).
- Where the Gyproc Styletrim runs along the line of the framing, fix at 150mm centres.

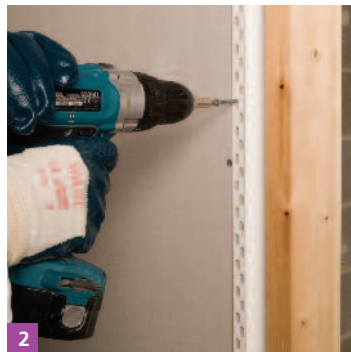

- Insert the screw through the slot in the fin nearest to the centre line of the framing member, and fix using a slow speed screwdriver.

NB Select screws of adequate length to engage the framing - when fixing to Gypframe studs through two layers of 12.5mm Gyproc plasterboard use 36mm Gyproc Drywall Screws, through one layer of 12.5mm board use 25mm Gyproc Drywall Screws. Ensure that the head is driven home fully to avoid fouling the trowel during subsequent jointing. For timber studs a minimum penetration of 25mm is required.

Sealant plus mechanical fixing

- Where maximum durability is required e.g. areas subject to impact such as all doors and skirtings, a combination of sealant and mechanical screw-fixing is recommended. In this situation, Gyproc Joint Tape should be used during the jointing process.

- Locate the Gyproc Styletrim using a continuous bead of Gyproc Sealant as described in 'Sealant fixing'.



- Insert Gyproc Drywall Screws as described in 'Mechanical fixing', earlier.



Jointing

- Lay on jointing material as required and firmly bed Gyproc Joint Tape.
- Follow on immediately with a further application of jointing material, filling out flush from the raised lip of the Gyproc Styletrim to the lining surface.

NB Ensure that the tape does not overlap the raised lip of the Gyproc Styletrim.

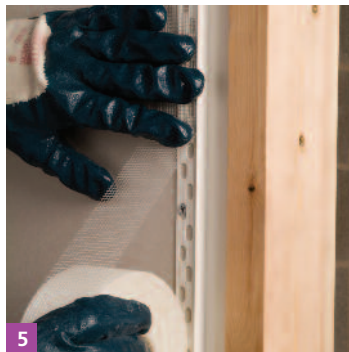

- Take care to remove any surplus material from the Gyproc Styletrim using a damp sponge or cloth.

- Finish the joint by applying one or two coats of jointing material as required.

NB Thistle ProTape FT50 can be used in place of paper tape. No bedding is required, but the jointing material must be pressed adequately through the tape mesh during trowelling. However, Gyproc Joint Tape provides greater resistant to cracking compared to Thistle ProTape FT50.

Quantity take-off details

Quantities

- 1 Choose system specification / height or area as required, as given in the left hand column.
- 2 Read across the columns to determine the quantity of each of the system components required.
- 3 Adjust quantities to suit actual number m² required.

Notes:

1. For partitions and linings, quantities are approximate for 100m² of installed system and do not include wastage or deflection head details.
2. Minimum overlap of stud where partition / lining height exceeds stud length is 600mm.
3. Please refer to the British Gypsum website www.british-gypsum.com to establish individual performance specifications. Alternatively, contact the Saint-Gobain Technical Academy on 0844 800 1991 for further assistance.

4. It is the responsibility of the ordering authority to check the above quantities against final drawings and bills of quantities before placing material orders.
5. The quantities stated are for British Gypsum components only. Where other materials are used in conjunction with the system, the appropriate manufacturer / supplier should be consulted for guidance.



Quantity take-off index

Partition and wall systems

GypWall CLASSIC	490-491
ShaftWall	499-499
GypWall QUIET SF	500-501

Wall lining systems

GypLyner UNIVERSAL	492-493
DriLyner	502-503

Ceiling systems

CasoLine MF	494-495
GypLyner UNIVERSAL	496-497

Finishing materials and accessories

Thistle plasters	504
Gyproc jointing materials / accessories	505
Gyproc and Thistle accessories	506
Fixings for Gyproc plasterboard	507

GypWall CLASSIC

Take-off calculator – based on 100m² partition

Partition specification maximum heights (Gypframe 'C' Stud ref. / board specification)	1 Partition height (mm)	1 Stud length (mm)						2 Gypframe Floor & Ceiling Channel (No.) (assumes no deflection at head of partition)	
		2400	2700	3000	3300	3600	4200		
146 S 50 2 x 12.5mm boards each side	7600	5	5	5	5	5	44	8 (ref: 148 DC 60)	
	7000	5	5	5	5	5	48	8 (ref: 148 DC 60)	
	6500	5	5	5	5	5	52	9 (ref: 148 DC 60)	
146 S 50 1 x 12.5mm board each side	6200	5	5	5	5	5	54	9 (ref: 148 DC 60)	
	6000	5	5	5	5	5	56	10 (ref: 148 DC 60)	
	5500	5	5	5	5	5	46	11 (ref: 148 DC 60)	
	5000	5	5	5	5	5	45	12 (ref: 148 DC 60)	
70 S 50 2 x 12.5mm boards each side	4600	5	5	5	5	55	46	13 (ref: 72 DC 60)	
	4400	5	5	5	5	57	46	13 (ref: 72 DC 60)	
	4200	5	5	5	60	53	40	14 (ref: 72 DC 60)	
	4000	5	5	5	63	56	42	14 (ref: 72 C 50)	
	3800	5	5	66	59	55	44	15 (ref: 72 C 50)	
70 S 50 – 1 x 12.5mm board each side	3600	5	5	70	62	47	47	16 (ref: 72 C 50)	
48 S 50 2 x 12.5mm boards each side	3400	5	74	66	62	50	5	17 (ref: 50 C 50)	
	3200	5	79	70	53	5	5	18 (ref: 50 C 50)	
	3000	84	74	56	5	5	5	19 (ref: 50 C 50)	
	2800	90	80	60	5	5	5	20 (ref: 50 C 50)	
	2600	86	64	5	5	5	5	22 (ref: 50 C 50)	
48 S 50 1 x 12.5mm board each side	2500	89	67	5	5	5	5	23 (ref: 50 C 50)	
	2400	70	5	5	5	5	5	24 (ref: 50 C 50)	

6

Gyproc Sealant - to suit; Isover insulation - as specified; additional framing - add one extra stud per stop end, abutment or external angle / two extra studs

	3					4 Boards and finishing	5 Gyproc Drywall Screws (per 100m ² of board)
	No. of Gypframe GFS1 Fixing Strap for board size (mm). Add 10 No. Gyproc Wafer Head Drywall Screws for each Gypframe GFS1 (single layer boarded partitions)						
	2400 x 1200	2700 x 1200	3000 x 1200	3300 x 1200	3600 x 1200		
	33	22	22	22	22	NUMBER OF BOARDS REQUIRED Single layer 2400 x 1200mm = 70 boards Double layer 2400 x 1200mm = 139 boards FINISHING Skim: Thistle Board Finish Thistle Multi-Finish Thistle Durafinish Jointing: Gyproc Joint Filler Gyproc Joint Cement Gyproc Ready Mix Joint Cement Gyproc Easi-Fill Gyproc Easi-Fill 45 METHODS OF REINFORCEMENT Gyproc Joint Tape (preferred) Gyproc Corner Tape Thistle ProTape FT50	SINGLE BOARDED 2250 No. DOUBLE BOARDED 1st layer - 1750 No. 2nd layer - 2250 No.
	24	24	24	24	12		
	26	26	26	13	13		
	27	27	27	14	14		
	28	28	14	14	14		
	31	31	16	16	16		
	34	17	17	17	17		
	19	19	19	19	19		
	19	19	19	19	19		
	20	20	20	20	20		
	21	21	21	21	21		
	22	22	22	22	22		
	24	24	24	24	0		
	25	25	25	25	0		
	26	26	26	0	0		
	28	28	0	0	0		
	30	30	0	0	0		
	33	0	0	0	0		
	34	0	0	0	0		
	0	0	0	0	0		

and one extra channel per door opening.



Reference should be made to the **WHITE BOOK** for information on when the use of EDC (Extra Deep Flange Floor & Ceiling Channel) is recommended and / or information on standard deflection head details.

GypLyner UNIVERSAL - wall lining

Take-off calculator for 100m² of lining

Wall lining height (mm)	1				Gypframe GL2 / GL9 Bracket (No.) plus Gypframe GL11 GypLyner Anchors (No.)	2				GL8 Track (No.)
	Gypframe GL1 Lining Channel length (mm)					No. of Gypframe GL3 Channel Connectors for Gypframe GL1 Lining Channel lengths (mm)				
	2400	2700	3000	3600		2400	2700	3000	3600	
7500	70	62	56	47	198	67	45	45	45	8
7000	70	62	56	47	184	48	48	48	24	8
6500	70	62	56	47	200	52	52	52	26	9
6000	70	62	56	47	189	56	56	28	28	10
5500	70	62	56	47	180	61	61	31	31	11
5000	70	62	56	47	198	67	34	34	34	12
4600	70	62	56	47	180	37	37	37	37	13
4400	70	62	56	47	185	38	38	38	38	13
4200	70	62	56	47	195	40	40	40	40	14
4000	70	62	56	47	164	42	42	42	42	14
3800	70	62	56	47	172	44	44	44	44	15
3600	70	62	56	47	184	47	47	47	5	16
3400	70	62	56	47	196	50	50	50	5	17
3200	70	62	56	5	156	53	53	53	5	18
3000	70	62	56	5	165	56	56	5	5	19
2800	70	62	56	5	177	60	60	5	5	20
2600	70	62	5	5	192	65	5	5	5	22
2400	70	62	5	5	138	5	5	5	5	24

6 Gyproc Sealant to suit. Gypframe Wafer Head Drywall Screws - 500 No./100m²; GL1 - add one extra for each internal and external angle, and each door angle, and one / two extra for each window opening. Isover insulation as specified.

	3 No. of Gypframe GFT1 Fixing 'T' or Gypframe GFS1 Fixing Strap for board size (mm)					4 Boards and finishing	5 Gyproc Drywall Screws
	2400 x 1200	2700 x 1200	3000 x 1200	3300 x 1200	3600 x 1200		
	17	12	12	12	12	NUMBER OF BOARDS REQUIRED 2400 x 1200mm = 35 Boards FINISHING Skim: Thistle Board Finish Thistle Multi-Finish Thistle Durafinish Jointing: Gyproc Joint Filler Gyproc Joint Cement Gyproc Ready Mix Joint Cement Gyproc Easi-Fill Gyproc Easi-Fill 45 METHODS OF REINFORCEMENT Gyproc Joint Tape (preferred) Gyproc Corner Tape Thistle ProTape FT50	SINGLE BOARDED 1090 No.
	18	12	12	12	6		
	13	13	13	7	7		
	14	14	7	7	7		
	16	16	8	8	8		
	17	9	9	9	9		
	10	10	10	10	10		
	10	10	10	10	10		
	10	10	10	10	10		
	11	11	11	11	11		
	11	11	11	11	11		
	12	12	12	12	5		
	13	13	13	13	5		
	13	13	13	5	5		
	14	14	5	5	5		
	15	15	5	5	5		
	16	5	5	5	5		
	5	5	5	5	5		

and window opening. Multiply upwards if lining height exceeds Gypframe GL1 Lining Channel length; Gypframe GL8 Track - add one extra for each internal

Take-off calculator

Ceiling area (m ²)	1 Casoline MF ceiling channels and accessories ref.						
	MF5 (No.)	MF6 (No.)	MF7 (No.)	MF8 (metres)	MF9 (No.)	MF11 (No.)	MF12 (No.)
5	4	varies	2	4	10	10	10
10	7		3	7	20	10	10
20	13	depending	5	13	40	20	20
30	20		7	20	60	30	20
40	26	on	9	26	80	40	30
50	32		12	32	100	50	40
60	39	the	14	39	120	60	40
70	45		16	45	130	70	50
80	52	ceiling	18	52	150	80	60
90	58		20	58	170	90	60
100	64	perimeter	23	64	190	100	70

2 Additional information

- Component codes above refer to: MF5 = Gypframe MF5 Ceiling Section (3600mm); MF6 = Gypframe MF6 Perimeter Channel; MF7 = Gypframe MF7 Primary Support Channel; MF8 = Gypframe MF8 Strap Hanger; MF9 = Gypframe MF9 Connecting Clip; MF11 = Gypframe MF11 Nut and Bolt; MF12 = Gypframe MF12 Soffit Cleat.
- Quantities based on 1 metre depth of suspension.

1							Finishing and methods of reinforcement
Single layer boards			Double layer boards				
12.5mm Gyproc plasterboard/Multiboard 1800 x 900mm (No.)	25mm Gyproc Drywall Screws (No.)	Gyproc Wafer Head Jack-Point Screws (No.)	12.5mm Gyproc plasterboard/Multiboard 1800 x 900mm (No.)	25mm Gyproc Drywall Screws (No.)	36mm Gyproc Drywall Screws (No.)		
4	90	20	7	90	90	FINISHING Skim: Thistle Board Finish Thistle Multi-Finish Thistle Durafinish Jointing: Gyproc Joint Filler Gyproc Joint Cement Gyproc Ready Mix Joint Cement Gyproc Easi-Fill Gyproc Easi-Fill 45 METHODS OF REINFORCEMENT Gyproc Joint Tape (preferred) Gyproc Corner Tape Thistle ProTape FT50	
7	180	40	13	180	180		
13	360	70	26	360	360		
19	540	100	38	540	540		
25	720	130	50	720	720		
31	900	160	62	900	900		
38	1080	190	76	1080	1080		
44	1260	220	88	1260	1260		
50	1440	250	100	1440	1440		
56	1620	290	112	1620	1620		
62	1800	320	124	1800	1800		

3. Quantities are based on a maximum recommended load on the CasoLine ceiling grid (including the weight of the board) of 30kg/m³ Gyproframe MF5 Ceiling Section at 450mm centres.

4. These quantities do not cover the installation of Artec Gyptone and Artec Rigitone board - for more information please see the British Gypsum Ceilings Installation Guide (www.british-gypsum.com).

Take-off calculator

Ceiling area (m ²)	GypLyner channels and accessories ref.				Single layer boards (62 number required)	
	GL1 (No.)	GL3 (No.)	GL5 (No.) (or GL6)	GL8 (No.)	12.5mm Gyproc plasterboard based on 1800 x 900mm (No.)	25mm Gyproc Drywall Screws (No.)
5	5	5	12	varies	4	90
10	10	10	24		7	180
20	19	19	48	depending	13	360
30	28	28	72		19	540
40	38	38	96	on	25	720
50	47	47	120		31	900
60	56	56	144	the	38	1080
70	66	66	168		44	1260
80	75	75	192	ceiling	50	1440
90	84	84	216		56	1620
100	93	93	240	perimeter	62	1800

2 Additional information

- Component codes above refer to: GL1 = Gypframe GL1 Lining Channel (2400mm); GL3 = Gypframe GL3 Channel Connector; GL5 = Gypframe GL5 Timber Connector (70mm); GL8 = Gypframe GL8 Track.
- Gypframe GL5 Timber Connector allows for a maximum 35mm cavity depth when fixed to timber joists; Gypframe GL6 Timber Connector can be used in place of the Gypframe GL5 and will allow a maximum cavity depth of 120mm.
- For applications below a concrete soffit, Gypframe GL2 or GL9 Brackets can be substituted for the Gypframe GL5; Gypframe GL2 Bracket allows for a stand-off of 25mm - 75mm plus the lining thickness; Gypframe GL9 Bracket allows for a stand-off of 25mm - 125mm plus lining thickness.
- Number of Gyproc Wafer Head Drywall Screws required: 500 (No.) / 100m² of ceiling lining, using Gypframe GL2 or GL9 Brackets.

Double layer boards (124 number required)				Finishing and methods of reinforcement
	12.5mm Gyproc plasterboard based on 1800 x 900mm (No.)	25mm Gyproc Drywall Screws (No.)	36mm Gyproc Drywall Screws (No.)	
	8	90	90	FINISHING Skim: Thistle Board Finish Thistle Multi-Finish Thistle Durafinish Jointing: Gyproc Joint Filler Gyproc Joint Cement Gyproc Ready Mix Joint Cement Gyproc Easi-Fill Gyproc Easi-Fill 45 METHODS OF REINFORCEMENT Gyproc Joint Tape (preferred) / Gyproc Corner Tape Thistle ProTape FT50
	14	180	180	
	26	360	360	
	38	540	540	
	50	720	720	
	62	900	900	
	76	1080	1080	
	88	1260	1260	
	100	1440	1440	
	112	1620	1620	
	124	1800	1800	

Take-off calculator

Partition specification	Gypframe floor channel (No.)	Gypframe ceiling channel (No.)	Gypframe starter channel (No.)	Gypframe studs (No.)	Gypframe retaining Channel (No.)	Gyproc FireLine 2400x1200 (No.)	Gypframe GA3 Steel Angle (No.)	Gypframe Fixing Strap (No.)	Gyproc CoreBoard (+ fire-stops) (No.)	1		
										Gyproc Fire Strip (No.)		
60mm stud framing 60 mins fire resistance, based on 2 shafts. Each shaft size 4.2m x 4.2m x 3m high and including 1 door in each shaft	62 C 50	62 JC 70	60 SC 55 3600mm	60 I 70 3600mm	G102	15mm	-	14	59	10		
	9	14	20	49	145	35						
60mm stud framing 120 mins fire resistance, based on 2 shafts. Each shaft size 3m x 3m x 4.5m high and including 1 door in each shaft	62 C 50	62 JC 70	60 SC 55 3600mm	60 I 70 3600mm	G102	15mm	8	10	63	7		
	7	13	25	41	156	80						
92mm stud framing 90 mins fire resistance, based on 1 shaft. Shaft size 4.2m x 4.2m x 6m high and including 1 door in shaft	94 C 70	94 EDC 70	92 SC 90 6000mm	92 I 90 6000mm	G105	12.5mm	6	14	58	5		
	5	9	10	25	145	70						
146mm stud framing 120 mins fire resistance, based on 1 shaft. Shaft size 3m x 3m x 7.9m high and including 1 door in shaft	148 DC 60	148 EDC 80	148 TSC 90 6000mm	146 TI 90 6000mm	G102	G105	15mm	8	15	62	4	
	4	8	14	22	138	14	68					

	Gyproc Wafer Head Drywall Screws (No.)	Gyproc Wafer Head Jack-Point Screws (No.)	Gyproc Drywall Screws (No.)				Gyproc Jack-Point Screws (No.)			Gyproc Sealant (Litres)	Finishing and methods of reinforcement
			25mm	32mm	42mm	50mm	25mm	35mm	41mm		
	110	-	1090	-	-	-	-	-	-	2 L	FINISHING Skim: Thistle Board Finish Thistle Multi-Finish Thistle Durafinish Jointing: Gyproc Joint Filler Gyproc Joint Cement Gyproc Ready Mix Joint Cement Gyproc ProMix LITE Gyproc Easi-Fill Gyproc Easi-Fill 45 METHODS OF REINFORCEMENT Gyproc Joint Tape (preferred) Thistle ProTape FT50 Gyproc Corner Tape / Gyproc Drywall Angle Bead (external angles)
	-	2170	1240	130	1240	-	-	-	-	3 L	
	-	-	-	90	-	170	1090	1090	-	2 L	
	700	-	-	130	-	320	1060	-	1060	3 L	

GypWall QUIET SF

Take-off calculator – based on 100m² partition

Partition specification maximum heights (Gypframe 'C' Stud ref. / board specification)	1	1						2	
	Partition height (mm)	Stud length (mm)						Gypframe Floor & Ceiling Channel (No.) (assumes no deflection at head of partition)	
		2400	2700	3000	3300	3600	4200		
70 S 50 - 2 x 12.5mm board each side OR 2 x 15mm board each side	2400	70	5	5	5	5	5	24 (ref: 72 C 50)	
	2600	86	64	5	5	5	5	22 (ref: 72 C 50)	
	2800	90	80	60	5	5	5	20 (ref: 72 C 50)	
	3000	84	74	56	5	5	5	19 (ref: 72 C 50)	
	3200	5	79	70	53	5	5	18 (ref: 72 C 50)	
	3400	5	74	66	62	50	5	17 (ref: 72 C 50)	
	3600	5	5	70	62	47	47	16 (ref: 72 C 50)	
	3800	5	5	66	59	55	44	15 (ref: 72 C 50)	
	4000	5	5	5	63	56	42	14 (ref: 72 C 50)	
70 S 50 - 2 x 15mm board each side	4200	5	5	5	60	53	40	14 (ref: 72 C 50)	
92 S 50 - 2 x 12.5mm board each side OR 2 x 15mm board each side	4400	5	5	5	5	57	46	13 (ref: 94 DC 60)	
	4600	5	5	5	5	55	46	13 (ref: 94 DC 60)	
	5000	5	5	5	5	5	45	12 (ref: 94 DC 60)	
146 S 50 - 2 x 12.5mm board each side OR 2 x 15mm board each side	5200	5	5	5	5	5	48	11 (ref: 148 DC 60)	
	5400	5	5	5	5	5	47	11 (ref: 148 DC 60)	
	5700	5	5	5	5	5	44	10 (ref: 148 DC 60)	
	6000	5	5	5	5	56	56	10 (ref: 148 DC 60)	
	6300	5	5	5	5	53	53	9 (ref: 148 DC 60)	
	6600	5	5	5	5	51	51	9 (ref: 148 DC 60)	
	6800	5	5	5	5	5	49	9 (ref: 148 DC 60)	

6

Gyproc Wafer Head Drywall Screws - approx. 400 No. (based on Gypframe Resilient Bar to one side); Gyproc Sealant (35 lm per 0.93 cartridge); Isover

2		3			4	5
Gypframe RB1 Resilient Bar		No. of Gypframe GFS1 Fixing Strap for board size (mm)				
One side	Both sides	2400 x 1200	2700 x 1200	3000 x 1200	NUMBER OF BOARDS REQUIRED Single layer 2400 x 1200 x 12.5mm board plus one layer 2400 x 600 x 19mm board = 139 boards (19mm) 70 boards (12.5mm) Double layer 2400 x 1200 x 12.5mm or 15mm board = 139 boards FINISHING Skim: Thistle Board Finish Thistle Multi-Finish Thistle Durafinish Jointing: Gyproc Joint Filler Gyproc Joint Cement Gyproc Ready Mix Joint Cement Gyproc Easi-Fill Gyproc Easi-Fill 45	Gyproc Drywall Screws (per 100m ² of board) 1st layer - 12.5 or 15mm 1700 No. 1st layer - 19mm 1300 No. 2nd layer - 12.5 or 15mm 2200 No.
70	140	X	X	X		
77	154	33	X	X		
72	144	30	30	X		
67	134	28	28	X		
73	146	26	26	26		
69	X	25	25	25		
65	X	24	24	24		
71	X	22	22	22		
67	X	21	21	21		
64	X	20	20	20		
69	X	19	19	19		
66	X	19	19	19		
67	X	34	17	17		
65	130	32	16	16		
62	124	31	16	16		
65	130	30	30	15		
62	X	28	28	14		
64	X	27	27	27		
61	X	26	26	26		
64	X	25	25	25		

insulation required to suit; Additional studs: add 1 extra stud for each of the following:- Stop ends, abutment and external angle
add 2 extra studs for each door opening and 1 extra floor / ceiling channel

Take-off calculator - based on 100m² lining, 2.4m height

1		2		
System name	Description	Gyproc Dri-Wall Adhesive	MF10 Channel	
British Gypsum DriLyner BASIC	Gyproc WallBoard (excluding DUPLEX board)	400kg per 100m ²	N/A	
	9.5mm or 12.5mm thickness and 900mm or 1200mm width			
British Gypsum DriLyner TL	Gyproc ThermaLine thermal laminates, all thicknesses - 1200mm width	380kg per 100m ²	N/A	
British Gypsum DriLyner SL	Gyproc TriLine, 52mm thickness and 900mm width	450kg per 100m ²	N/A	
British Gypsum DriLyner MF	Gyproc WallBoard (including DUPLEX board) 1200mm width	300kg per 100m ²	105 No. per 100m ²	
	Gyproc ThermaLine thermal laminates, all thicknesses - 1200mm width	300kg per 100m ²	105 No. per 100m ²	
British Gypsum DriLyner RF	Gyproc ThermaLine thermal laminates, all thicknesses - 1200mm width	N/A	N/A	
	Gyproc Tri-Line, 52mm thickness and 900mm width	N/A	N/A	

2					Finishing and methods of reinforcement
Approximate quantities required – all Gypframe and Gyproc products					
	Drywall Screws	Sealant (0.93 litre)	Nailable Plugs	Skirting Plates	<p>FINISHING Thistle Board Finish Thistle Multi-Finish Thistle Durafinish</p> <p>Jointing: Gyproc Joint Filler Gyproc Joint Cement Gyproc Ready Mix Joint Cement Gyproc ProMix LITE Gyproc Easi-Fill Gyproc Easi-Fill 45 Gyproc Drywall Primer / Sealer</p> <p>METHODS OF REINFORCEMENT Gyproc Joint Tape (preferred) Thistle ProTape FT50 Gyproc Corner Tape</p>
	N/A	N/A	N/A	N/A	
	N/A	N/A	N/A	N/A	
	N/A	N/A	2 per board	2 per board	
	1080 No. per 100m ²	N/A	N/A	N/A	
	630 No. per 100m ²	12 No. per 100m ²	N/A	N/A	
	N/A	16 No. per 100m ²	2 per board	N/A	
	N/A	32 No. per 100m ²	2 per board	N/A	

Take-off calculator – Thistle plasters

Type of plaster	Plaster	Nominal bag weight kg	Approx. coverage per 25kg bag m ²	Approx. setting time on background hours	Shelf life
Undercoats	Thistle Bonding Coat	25	2.75 @ 11mm	1.5 - 2	All plaster bags have the use by date printed on the bag
	Thistle Hardwall	25	3.0 @ 11mm	1.5 - 2	
	Thistle Tough Coat	25	3.5 @ 11mm	1.5 - 2	
	Thistle Browning	25	3.5 @ 11mm	1.5 - 2	
	Thistle Dri-Coat	25	3.25 @ 11mm	N/A	
	Thistle X-Ray	25	1 @ 11mm	1.5 - 2	
Finishing coats	Thistle Board Finish	25	10 @ 2mm	1.5	
	Thistle Multi-Finish	25	10 @ 2mm	1.5	
	Thistle Durafinish	25	10 @ 2mm	1.5	
One coats	Thistle Universal One Coat	25	2.25 @ 13mm	1.5 - 2	
	Thistle Projection	25	2.0 @ 13mm	1.5 - 2	

Take-off calculator – Gyproc jointing materials / accessories

	Product	Container	Typical coverage per 100 m ²	Approx. setting time minutes	Shelf life months
Setting	Gyproc Joint Filler	12.5kg bag	25kg ¹	120	6
	Gyproc Easi-Fill	10kg bag	40kg	140	6
	Gyproc Easi-Fill 45	10kg bag	40kg	70	6
Air Drying	Gyproc Joint Cement	22.5kg bag	35kg ²	N/A	6
	Gyproc Ready Mix Joint Cement	12 litre tub	2.5 - 3 tubs	N/A	6
	Gyproc ProMix LITE Joint Cement	17 litre tub	2 tubs	N/A	6
Accessories	Gyproc Joint Tape	150m roll	1 roll	N/A	N/A
	Gyproc Drywall Primer	10 litre tub	9 litre (1 coat)	N/A	6
	Gyproc Drywall Sealer	10 litre tub	15 litre (2 coats)	N/A	6

¹ Plus 12kg Gyproc Joint Cement for finishing coat.

² If used for all coats.

Finishing materials and accessories (cont'd)

Take-off calculator – Gyproc and Thistle accessories

Product	Container	Typical coverage	Shelf life (months)
ThistleBond-it	10 litre tub	22 litre per 100m ²	6
Thistle GypPrime	11 litre tub	11 litres per 100m ² (undiluted) 11 litres per 300m ² (diluted 1:2) 11 litres per 600m ² (diluted 1:5)	6
Gyproc Soundcoat Plus	25kg bag	500kg per 100m ²	6
Gyproc Sealant	0.93 litre cartridge	20 litres per 100m ² (when used as an adhesive) 1 litre per 35lm (when used for sealing airpaths - based on a 6mm bead)	12

Take-off calculator – Fixings for Gyproc plasterboard

	Depth (mm)	Gyproc Drywall Screws into metal (mm)	Gyproc Drywall Timber Screws (mm)
Plasterboard	9.5	25	32
	12.5	25 (22) ¹	38
	15	25	38
	19	32	41
	12.5 over 12.5	36	51
	15 over 15	42	60
	12.5 over 19	42	60
	15 over 19	N/A	60

¹ DriLyner MF system only

² Gyproc Drywall Screws

Take-off calculator – Fixings for Gyproc plasterboard (continued)

	Depth (mm)	Gyproc Drywall Screws into metal (mm)	Gyproc Drywall Timber Screws (mm)
ThermaLine Thermal laminates (excluding TriLine)	18	32	41
	22	36	50
	27, 30	42	60
	35	50	60
	38, 40	60	65
	48	60	75
	50	60	75
	53	65	85
	60	75	85
	63	75	95
	70	80	95
	78, 80	90	105
	90	105	115
	93	105	120
Approximate requirements Screws	Fixing length mm	Quantity per 100m ² of board	
	All	1500 No.	

¹ DriLyner MF system only

² Gyproc Drywall Screws

Boards

Gyproc plasterboards are the ultimate lining solution for today's buildings, providing high levels of fire, sound, thermal, moisture and impact resistance to create modern internal environments that offer comfort and safety for occupants.

They offer high quality, high performance linings for walls and ceilings, lift shafts and stairwells, corridors and auditoria, in buildings as diverse as houses, schools, hospitals and cinemas.

Glasroc specialist boards have been developed for demanding applications calling for high levels of combined fire, moisture, and impact resistance.

The unique properties of this exceptionally fine-surfaced, paperless gypsum board provide solutions for a range of applications, from frameless encasement of steelwork for advanced fire protection, thermal insulation of semi-exposed soffits and the lining of steel-framed walls in industrial buildings, to the creation of aesthetically inspiring curved structures.



Board product index

Gyproc standard plasterboards

Gyproc WallBoard	512
Gyproc WallBoard 4TE	512
Gyproc HandiBoard	513
Gyproc Plank	513

Gyproc performance plasterboards

Gyproc WallBoard TEN	514
Gyproc WallBoard DUPLEX	514
Gyproc Moisture Resistant	515
Gyproc FireLine	515
Gyproc FireLine DUPLEX	516
Gyproc FireLine MR	516
Gyproc CoreBoard	517
Gyproc SoundBloc	517
Gyproc SoundBloc F	518
Gyproc SoundBloc MR	518
Gyproc SoundBloc RAPID	519
Gyproc SoundBloc RAPID MR	519
Gyproc DuraLine	520
Gyproc DuraLine MR	520

Gyproc ThermaLine laminates

Gyproc TriLine	521
Gyproc ThermaLine BASIC	521
Gyproc ThermaLine PLUS	522
Gyproc ThermaLine PIR	522
Gyproc ThermaLine SUPER	523

Specialist boards

Glasroc FireCase s	523
Glasroc F MULTIBOARD	524
Glasroc H TILEBACKER	524
Rigidur H	525

Section key

- S/E - Plasterboard has a square edge
- T/E - Plasterboard has a tapered edge
-  - Thermal conductivity W/mK

EN 520:

- ▶ Refer to www.british-gypsum.com

Gyproc board dimensions

	Thickness mm	Width mm	Length mm	Weight kg/m ²	Thermal resistance m ² K/W	Tapered edge	Square edge
Gyproc WallBoard	9.5, 12.5 or 15	900 or 1200	1800 to 3600	6.3, 8.0, 9.8	0.05, 0.07, 0.08	Y	Y
Gyproc WallBoard 4TE	12.5	1200	2400	8.0	0.07	Y	N
Gyproc HandiBoard	9.5 or 12.5	600 or 900	1220	6.3, 8.0	0.05, 0.07	N	Y
Gyproc Plank	19	600	2400	15	0.10	Y	Y
Gyproc WallBoard TEN	12.5	1200	2400	10	0.07	Y	N
Gyproc WallBoard DUPLEX	12.5 or 15	900 or 1200	1800 to 3000	8.0, 9.8	0.41, 0.42 [†]	Y	Y
Gyproc Moisture Resistant	12.5 or 15	1200	2400 to 3000	8.6, 10.1	0.07, 0.08	Y	Y
Gyproc FireLine	12.5 or 15	900 or 1200	1800 to 3000	9.8, 11.7	0.05, 0.06	Y	Y
Gyproc FireLine DUPLEX	12.5	1200	2400	9.8	0.39 [†]	Y	N
Gyproc FireLine MR	12.5 or 15	1200	3000	9.8, 11.7	0.05, 0.06	Y	N
Gyproc CoreBoard	19	598	3000	16	0.08	N	Y
Gyproc SoundBloc	12.5 to 15	1200	2400 to 3000	10.6, 12.6	0.05, 0.06	Y	N
Gyproc SoundBloc F	15	1200	2400 to 3000	14.1	0.06	Y	N
Gyproc SoundBloc MR	12.5 to 15	1200	2400 to 2700	10.6, 12.6	0.05, 0.06	Y	N
Gyproc SoundBloc RAPID	15	900	1800 to 2700	12.6	0.06	Y	N
Gyproc SoundBloc RAPID MR	15	900	2400	12.6	0.06	Y	N
Gyproc DuraLine	15	1200	2400 or 3000	13.9	0.06	Y	N
Gyproc DuraLine MR	15	1200	2400 or 3000	13.9	0.06	Y	N

[†] Including 25mm minimum air space.

Gyproc and Glasroc board dimensions

	Thickness mm	Width mm	Length mm	Weight kg/m ²	Thermal resistance m ² /K/W	Tapered edge	Square edge
Gyproc TriLine	52	900	2400	13	1.25	Y	N
Gyproc ThermaLine BASIC	22, 30, 40	1200	2400	6.5, 7.2, 8.1	0.35, 0.55, 0.8,	Y	N
Gyproc ThermaLine PLUS	27, 35, 40,	1200	2400	6.5, 7.2, 7.7,	0.62, 0.89, 1.05,	Y	N
	48 [†]			8.1	1.23		
Gyproc ThermaLine PIR [†]	38, 53, 63,	1200	2400	9.4, 9.81, 10.1	1.15, 1.85, 2.30,	Y	N
	78, 93			10.52, 10.94	3.00, 3.65		
Gyproc ThermaLine SUPER	50	1200	2400	6.5	1.97	Y	N
	60			6.6	2.56		
	70, 80, 90			6.7, 6.8, 6.9	3.06, 3.56, 4.06		
Glasroc FireCase s	15, 20, 25	1200	2000 to 2400	12.8, 17, 21.3,	0.05, 0.07, 0.09,	N	Y
	or 30			25.5	0.10		
Glasroc F MULTIBOARD	6, 10 or 12.5	1200	2400 or 3000	6.0, 8.5, 10.6	0.02, 0.03, 0.04	N	Y
Glasroc H TILEBACKER	12.5	1200	900, 2400 to 3000	10.6	0.04	N	Y
Rigidur H	12.5, 15	1200	2400 to 3000	15, 18	0.04, 0.04	Y	N

[†] Faced with 12.5mm Gyproc WallBoard.

Gyproc WallBoard

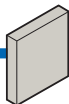

Characteristics: Standard board product.

Application: Suitable for most applications where normal fire, structural and acoustic levels are specified. Suitable for direct decoration or Thistle plaster finish.

Board colour

 - Ivory face paper.  - Brown reverse side paper.

Board printing

Face - screw centre markings 'x'.

Edge - product code, EAN number, board thickness x width x length, edge type.

Reverse - standard and certification.

Finishing

T/E - with Gyproc jointing materials for taped and filled joints or application of Thistle Board Finish or Thistle Multi-Finish plaster.

S/E - for plaster application, Artex texture finish or undecorated applications.

Standard and certification

EN 520 - Type A.

Thermal conductivity

 0.19W/mK.

Gyproc WallBoard 4TE

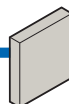

Characteristics: Standard non-performance board product

Application: Gyproc WallBoard 4TE (4 Tapered Edge) is a new non-performance board product designed for use in high specification public spaces that feature large area wall and ceiling surfaces which are subject to strong, direct lighting.

Board colour

 - Ivory face paper.  - Brown reverse side paper.

Board printing

Face - none.

Reverse - standard and certification.

Finishing

4T/E - with Gyproc jointing materials for taped and filled joints.

Standard and certification

EN 520 - Type A.

Thermal conductivity

 0.19W/mK.

Gyproc HandiBoard

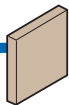

Characteristics: Easy-to-use board with ivory face paper. Suitable for direct decoration or Thistle plaster finish.

Application: Designed for Thistle plaster application. Length is compatible with both 16" and 24" joist centres, for ceiling linings.

Board colour

 - Ivory face paper.  - Brown reverse side paper.

Board printing

Face - none.

Edge - product code, EAN number, board thickness x width x length, edge type.

Reverse - standard and certification.

Finishing

S/E - for application of Thistle Board Finish or Thistle Multi-Finish plaster.

Standard and certification

EN 520 - Type P.

Thermal conductivity

 0.19W/mK.

Gyproc Plank

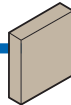



Characteristics: A 19mm thick version of Gyproc WallBoard.



Application: Used as the main board in British Gypsum GyproFloor SILENT, GyproWall AUDIO and GyproWall QUIET systems.

Board colour

T/E

 - Ivory face paper.
 - Brown reverse side paper.

S/E

 - Brown face paper.
 - Brown reverse side paper.

Board printing

Face - screw centre markings 'x'.

Edge - product code, EAN number, board thickness x width x length, edge type.

Reverse - standard and certification.

Finishing

T/E - with Gyproc jointing materials for taped and filled joints or application of Thistle Board Finish or Thistle Multi-Finish plaster.

S/E - when used as a core or in-fill board.

Standard and certification

EN 520 - Type A.

Thermal conductivity

 0.19W/mK.

Gyproc WallBoard TEN

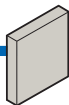

Characteristics: Standard board product with specifically engineered weight of 10kg/m²

Application: Engineered to meet the guidance given in the national Building Regulations Part E (transmission of sound), that states plasterboard, where used, must have a minimum mass of 10kg/m² for internal and separating constructions in all residential projects, both new-build and refurbishment.

Board colour

■ - Ivory face paper. ■ - Brown reverse side paper.

Board printing

Face - Gyproc WallBoard TEN, screw centre markings 'x'.

Edge - product code, EAN number, board thickness x width x length, edge type.

Reverse - standard and certification.

Finishing

T/E - with Gyproc jointing materials for taped and filled joints or application of Thistle Board Finish or Thistle Multi-Finish plaster.

Standard and certification

EN 520 - Type D.

Thermal conductivity

🔥 0.19W/mK.

Gyproc WallBoard DUPLEX

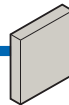

Characteristics: Gyproc WallBoard backed with a vapour control membrane.

Application: Used for wall and ceiling linings where vapour control and a plasterboard lining are required in one fixing operation.

Board colour

■ - Ivory face paper. ■ - Metalised polyester film, reverse.

Board printing

Face - screw centre markings 'x'.

Edge - product code, EAN number, board thickness x width x length, edge type.

Finishing

T/E - with Gyproc jointing materials for taped and filled joints or application of Thistle Board Finish or Thistle Multi-Finish plaster.

S/E - for plaster application, Artex texture finish or undecorated applications.

Standard and certification

EN 14190

Thermal conductivity

🔥 0.19W/mK.

Gyproc Moisture Resistant

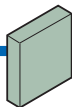

Characteristics: Gypsum plasterboard with water repellent additives in the core and paper liners.

Application: Suitable as a base for tiling in wet use areas. Also used for external soffits in sheltered positions.

Board colour

 - Green face paper.  - Green reverse side paper.

Board printing

Face - screw centre markings 'x'.

Edge - product code, EAN number, board thickness x width x length, edge type.

Reverse - standard and certification.

Finishing

T/E - with Gyproc jointing materials for taped and filled joints.

S/E - for undecorated applications or as a base for ceramic tiling.

Standard and certification

EN 520 - Types A and H1.

Thermal conductivity

 0.19W/mK.

Gyproc FireLine

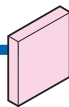

Characteristics: Gypsum plasterboard with glass fibre and other additives in the core.

Application: Used in British Gypsum partition, wall lining and ceiling systems to give increased fire protection. Also used for protection to structural steel.

Board colour

 - Pink face paper.  - Brown reverse side paper.

Board printing

Face - screw centre markings 'x'.

Edge - product code, EAN number, board thickness x width x length, edge type.

Reverse - standard and certification.

Finishing

T/E - with Gyproc jointing materials for taped and filled joints or application of Thistle Board Finish or Thistle Multi-Finish plaster.

S/E - for plaster application, Artex texture finish or undecorated applications.

Standard and certification

EN 520 - Type F.

Thermal conductivity

 0.24W/mK.

Gyproc FireLine DUPLEX

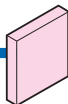

Characteristics: Gypsum plasterboard with glass fibre and other additives in the core, backed with a vapour control membrane.

Application: Used in British Gypsum partition, wall lining and ceiling systems to give increased fire protection with vapour control. Also used for protection to structural steel.

Board colour

 - Pink face paper.  - Metalised polyester film.

Board printing

Face - screw centre markings 'x'.

Edge - product code, EAN number, board thickness x width x length, edge type.

Finishing

T/E - with Gyproc jointing materials for taped and filled joints or application of Thistle Board Finish or Thistle Multi-Finish plaster.

Standard and certification

EN 14190.

Thermal conductivity

 0.24W/mK.

Gyproc FireLine MR

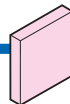

Characteristics: Gyproc FireLine with water repellent additives in the core.

Application: Used in British Gypsum partition and wall lining systems where both fire protection and moisture resistance are required. Also used for protection to structural steel.

Board colour

 - Pink face paper.  - Pink reverse side paper.

Board printing

Face - Gyproc FireLine MR, screw centre markings 'x'.

Edge - product code, EAN number, board thickness x width x length, edge type.

Reverse - standard and certification.

Finishing

T/E - with Gyproc jointing materials for taped and filled joints.

Standard and certification

EN 520 - Type F, H1.

Thermal conductivity

 0.24W/mK.

Gyproc CoreBoard

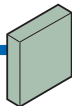

Characteristics: A 19mm thick version of Gyproc FireLine MR board.

Application: Used as the main board in the British Gypsum ShaftWall system to provide fire protection with temporary moisture protection during construction.

Board colour

 - Green face paper.  - Green reverse side paper.

Board printing

Face - screw centre markings 'x'.

Edge - product code, EAN number, board thickness x width x length, edge type.

Reverse - standard and certification.

Standard and certification

EN 520 - Types D, F and H1.

Thermal conductivity

 0.24W/mK.

Gyproc SoundBloc

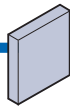

Characteristics: Gypsum plasterboard with a higher density core.

Application: Designed for use in British Gypsum wall and partition systems where greater levels of sound insulation are required.

Board colour

 - Pale blue face paper.  - Brown reverse side paper.

Board printing

Face - screw centre markings 'x'.

Edge - product code, EAN number, board thickness x width x length, edge type.

Reverse - standard and certification.

Finishing

T/E - with Gyproc jointing materials for taped and filled joints or application of Thistle Board Finish or Thistle Multi-Finish plaster.

Standard and certification

EN 520 - Type D.

Thermal conductivity

 0.25W/mK.

Gyproc SoundBloc F

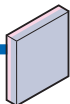

Characteristics: Gypsum plasterboard with a higher density core.

Application: Designed for use in British Gypsum wall and partition systems where greater levels of sound insulation and fire resistance are required.

Board colour

 - Pale blue face paper.  - Pink reverse side paper.

Board printing

Face - screw centre markings 'x'.

Edge - product code, EAN number, board thickness x width x length, edge type.

Reverse - standard and certification.

Finishing

T/E - with Gyproc jointing materials for taped and filled joints or application of Thistle Board Finish, Thistle DuraFinish or Thistle Multi-Finish plaster.

Standard and certification

EN 520 - Type D and F.

Thermal conductivity

 0.25W/mK.

Gyproc SoundBloc MR

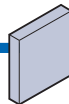

Characteristics: Gypsum plasterboard with a higher density core and water repellent additives.

Application: Designed for use in British Gypsum wall and partition systems where moisture resistance and greater levels of sound insulation are required.

Board colour

 - Pale blue face paper.  - Green reverse side paper.

Board printing

Face - Gyproc SoundBloc MR, screw centre markings 'x'.

Edge - product code, EAN number, board thickness x width x length, edge type.

Reverse - standard and certification.

Finishing

T/E - with Gyproc jointing materials for taped and filled joints.

Standard and certification

EN 520 - Types D and H1.

Thermal conductivity

 0.25W/mK.

Gyproc SoundBloc RAPID

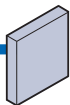

Characteristics: Gypsum plasterboard with a higher density core, in a special dimensional configuration.

Application: Used in the British Gypsum GypWall RAPID dB Plus system, a quick to erect, high performance internal wall system for housing applications.

Board colour

 - Pale blue face paper.  - Brown reverse side paper.

Board printing

Face - Screw centre markings 'x'.

Edge - product code, EAN number, board thickness x width x length, edge type.

Reverse - standard and certification.

Finishing

T/E - with Gyproc jointing materials for taped and filled joints or application of Thistle Board Finish or Thistle Multi-Finish plaster.

Standard and certification

EN 520 - Type D.

Thermal conductivity

 0.25W/mK.

Gyproc SoundBloc RAPID MR

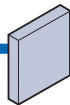

Characteristics: Gypsum plasterboard with moisture resistant additives and a higher density core, in a special dimensional configuration.

Application: Used in the British Gypsum GypWall RAPID dB Plus system, a quick to erect, high performance internal wall system for housing applications.

Board colour

 - Pale blue face paper.  - Green reverse side paper.

Board printing

Face - Gyproc SoundBloc RAPID MR, screw centre markings 'x'.

Edge - product code, EAN number, board thickness x width x length, edge type.

Reverse - standard and certification.

Finishing

T/E - with Gyproc jointing materials for taped and filled joints or as a base for tiling.

Standard and certification

EN 520 - Types D and H1.

Thermal conductivity

 0.25W/mK.

Gyproc DuraLine

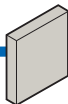

Characteristics: Higher density core with glass fibre and other additives.

Application: Designed for use in the British Gypsum GypWall ROBUST system to give greater impact resistance in heavy use areas.

Board colour

■ - Ivory face paper. ■ - Brown reverse side paper.

Board printing

Face - Gyproc DuraLine, screw centre markings 'x'.

Edge - product code, EAN number, board thickness x width x length, edge type.

Reverse - standard and certification.

Finishing

T/E - with Gyproc jointing materials for taped and filled joints or application of Thistle Board Finish or Thistle Multi-Finish plaster.

Standard and certification

EN 520 - Types D, F, I and R.

Thermal conductivity

λ 0.25W/mK.

Gyproc DuraLine MR

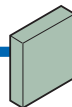

Characteristics: Gyproc DuraLine with water repellent additives in the core.

Application: Designed for use in the British Gypsum GypWall ROBUST system to give moisture resistance and greater impact resistance in heavy use areas.

Board colour (15mm)

■ - Green face paper
■ - Green reverse side paper.

Board printing

Face - Gyproc DuraLine MR, screw centre markings 'x'.

Edge - product code, EAN number, board thickness x width x length, edge type.

Reverse - standard and certification.

Finishing

T/E - with Gyproc jointing materials for taped and filled joints.

Standard and certification

EN 520 - Types D, F, I, R and H1.

Thermal conductivity

λ 0.25W/mK.

Gyproc TriLine

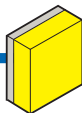

Characteristics: Gyproc WallBoard bonded to CFC and HCFC-free, glass mineral wool backing. An optional vapour check grade is available.

Application: Used to upgrade the acoustic performance of masonry separating walls, whilst also providing some improvement to thermal insulation.

Board colour

-  - Faced with ivory coloured Gyproc WallBoard.
-  - Backed with yellow coloured glass mineral wool.

Board printing

Face - screw centre markings 'x'.

Edge - product code, EAN number, board thickness x width x length, edge type.



Finishing

T/E - with Gyproc jointing materials for taped and filled joints or application of Thistle Board Finish or Thistle Multi-Finish plaster.

Standard and certification

EN 13950

Thermal conductivity

-  Gyproc WallBoard - 0.19W/mK.
-  Gyproc TriLine mineral wool - 0.033W/mK.

Gyproc ThermaLine BASIC

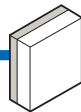

Characteristics: Gyproc WallBoard factory-bonded to an expanded polystyrene insulant that is both CFC and HCFC-free - meaning zero ODP (Ozone Depletion Potential). This product also has a GWP (Global Warming Potential) of <5%. An optional vapour check grade is available to reduce the risk of condensation.

Application: Can be used in both refurbishment and new-build where a basic level of additional thermal insulation is required.

Board colour

-  - Faced with ivory coloured Gyproc WallBoard.
-  - Backed with white coloured expanded polystyrene.

Board printing

Face - screw centre markings 'x'.

Edge - product code, EAN number, board thickness x width x length, edge type.



Finishing

T/E - with Gyproc jointing materials for taped and filled joints or application of Thistle Board Finish or Thistle Multi-Finish plaster.

Standard and certification

EN 13950.

Thermal conductivity

-  Gyproc WallBoard - 0.19W/mK.
-  Gyproc ThermaLine BASIC expanded polystyrene -0.040W/mK.



Gyproc ThermaLine PLUS



Characteristics: Gyproc WallBoard factory-bonded to an extruded polystyrene insulant that is both CFC and HCFC-free - meaning zero ODP (Ozone Depletion Potential). This product also has a GWP (Global Warming Potential) of <5%. The closed cell structure of the foam provides integral vapour control.

Application Suitable for new buildings and for upgrading existing buildings when mid to high thermal performance is required.

Board colour

-  - Faced with ivory coloured Gyproc WallBoard.
-  - Backed with orange coloured extruded polystyrene.

Board printing

Face - screw centre markings 'x'.

Edge - product code, EAN number, board thickness x width x length, edge type.



Finishing

T/E - with Gyproc jointing materials for taped and filled joints or applications of Thistle Board Finish or Thistle Multi-Finish plaster.

Standard and certification

EN 13950.

Thermal conductivity

-  Gyproc WallBoard - 0.19W/mK.
-  Gyproc ThermaLine PLUS extruded polystyrene - 0.033W/mK.

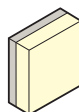

Gyproc ThermaLine PIR



Characteristics: Gyproc WallBoard factory-bonded to CFC-free, high thermal performance PIR insulant, which is zero ODP (Ozone Depletion Potential). This product also has a GWP (Global Warming Potential) of <5%. Has good fire performance, with Class 0 rating to plasterboard face. Also has low toxicity and smoke obscuration of less than 5%. Includes a vapour control layer as standard to reduce risk of condensation.

Application A very high performing, yet cost-effective, thermal laminate used for refurbishment and room-in-the-roof applications where a substantial upgrade in thermal insulation is required.

Board colour

-  - Faced with ivory coloured Gyproc WallBoard.
-  - Backed with beige coloured PIR kraft paper.

Board printing

Face - screw centre markings 'x'.

Edge - product code, EAN number, board thickness x width x length, edge type.



Finishing

T/E - with Gyproc jointing materials for taped and filled joints or application of Thistle Board Finish or Thistle Multi-Finish plaster.

Standard and certification

EN 13950.

Thermal conductivity

-  Gyproc WallBoard - 0.19W/mK.
-  Gyproc ThermaLine PIR - 0.022W/mK.



Gyproc ThermaLine SUPER



Characteristics: Gyproc WallBoard factory-bonded to CFC-free, high thermal performance phenolic foam insulant, which is zero ODP (Ozone Depletion Potential). This product also has a GWP (Global Warming Potential) of <5%. Has good fire performance, with Class 0 rating to both faces. Also has low toxicity and smoke obscuration of less than 5%. Includes a vapour control layer as standard to reduce risk of condensation.

Application A very high performing, yet cost-effective, thermal laminate used for refurbishment and room-in-the-roof applications where a substantial upgrade in thermal insulation is required.

Board colour

-  - Faced with ivory coloured Gyproc WallBoard.
-  - Backed with brown coloured phenolic foam.

Board printing

Face - screw centre markings 'x'.

Edge - product code, EAN number, board thickness x width x length, edge type.



Finishing

T/E - with Gyproc jointing materials for taped and filled joints or application of Thistle Board Finish or Thistle Multi-Finish plaster.

Standard and certification

EN 13950.

Thermal conductivity

-  Gyproc WallBoard - 0.19W/mK.
-  Gyproc ThermaLine SUPER phenolic foam - 0.020 to 0.023W/mK (depending on thickness of foam).

Glasroc FireCase s

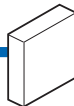

Characteristics: High performance Class 0, non-combustible board.

Application Used predominantly as part of the British Gypsum FireCase structural steel encasement system, giving up to 180 minutes fire protection.

Board colour

- White gypsum face.
- White gypsum reverse side.

Board printing

Face - none.

Edge - none.

Reverse - board thickness, product name.

Finishing

S/E - with exceptionally smooth surface for direct decoration or application of Thistle Board Finish or Thistle Multi-Finish plaster.

Standard and certification

BBA certificate number 93/2935.

Thermal conductivity

-  0.286W/mK.

Glasroc F MULTIBOARD

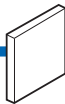

Characteristics: Highly versatile, Class 0, non-combustible glass-reinforced gypsum board.

Application Suitable for constructing all forms of partition and ceilings, including curved applications, giving high levels of fire and impact protection. Also offers increased levels of moisture performance. Can be used in semi-exposed situations such as eaves, canopies and carport under-linings.

Board colour

- White gypsum face. - White gypsum reverse side.

Board printing

Face - none.

Edge - none.

Reverse - board thickness, product name.

Finishing

S/E - the exceptionally smooth surface enables Glasroc F MULTIBOARD to be left unfinished or can be painted or papered directly. Alternatively finish with Gyproc jointing materials for taped and filled joints or applications of Thistle Board Finish or Thistle Multi-Finish plaster.

Thermal conductivity

 0.286W/mK.

Glasroc H TILEBACKER



Characteristics: Water resistant, Class A1 and Class 0, non-combustible glass-reinforced gypsum board.

Application Suitable as a tile backing board for use in environments subjected to moisture.

Board colour

 - Yellow face.

- White gypsum reverse side.

Board printing

Face - none.

Edge - none.

Reverse - board thickness, product name.

Finishing

S/E - the board is pre-primed with an acrylic coating suitable for direct tiling. In part-tiled areas not directly exposed to water, e.g. low moisture environments, the board can be finished with Gyproc jointing materials for taped and filled joints, or application of Thistle Board Finish, Thistle Multi-Finish or Thistle Durafinish plaster (in conjunction with ThistleBond-it).

Standard and certification

Conforms to *EN 15283-1 Types GM-H1*.

Thermal conductivity

 0.30W/mK.

Rigidur H



Characteristics: Rigidur H is a gypsum fibreboard which combines gypsum, cellulose fibres from recycled paper, and water, to form a dense sheet material that has superior rigidity, durability and mechanical strength.

Application Rigidur H is the outer board component in **GypWall EXTREME**, offering a British Gypsum system with increased rigidity and durability.

Board colour

-  - Beige face.
-  - Beige reverse side.

Board printing

Face - none.

Edge - none.

Reverse - product name, board thickness and standards.

Finishing

T/E - with Gyproc jointing materials for taped and filled joints or application of Thistle Board Finish, Thistle Multi-Finish or Thistle Durafinish plaster.

Rigidur H needs to be treated with Thistle GypPrime prior to skimming to control suction.

Standard and certification

Conforms to *EN 15283-2 Types GF*.

Thermal conductivity

 0.35W/mK.

Plasterboard accessories

The Gyproc range of accessories includes everything you need to finish plasterboard linings and partitions ready for decoration.

Every stage is catered for, from Gyproc Dri-Wall Adhesive for simple and quick board fixing, through reinforcement tapes and jointing compounds for perfect plasterboard joints, angles and arches, to Gyproc Primer and Sealer. There is also a range of products to cater for expansion, fire resistance and acoustic sealing - all designed to provide exactly the level of quality and performance required as part of an integrated, lifetime warranted, British Gypsum system.



Plasterboard accessories index

Jointing materials

Gyproc Joint Cement	528
Gyproc Ready Mix Joint Cement	528
Gyproc ProMix LITE Joint Cement	529
Gyproc Easi-Fill	529
Gyproc Easi-Fill 45	530
Gyproc Joint Filler	530
Gyproc Joint Tape	531
Gyproc Corner Tape	531
Gyproc Drywall Primer	532
Gyproc Drywall Sealer	532

Miscellaneous

Gyproc Sealant	533
Gyproc Soundcoat Plus	533
Gyproc Dri-Wall Adhesive	534
Gyproc Control Joint	534
Gyproc FireStrip	535

Beads

Gyproc Drywall Metal Angle Bead	535
Gyproc Drywall Archbead	536
Gyproc Drywall Metal Edge Bead	536
Gyproc Drywall Plastic Edge Bead	537

Gyproc Joint Cement



22.5kg bags

Characteristics

An air-drying, powdered jointing material.

Application

Used in the traditional 3-stage jointing process. Designed for the finishing stage over Gyproc Joint Filler in hand jointing, or for all application stages with mechanical jointing tools.

Gyproc Ready Mix Joint Cement



12 litre tubs

Characteristics

An air-drying, ready-mixed jointing material.

Application

Used in the traditional 3-stage jointing process. Designed for the finishing stage over Gyproc Joint Filler in hand jointing, or for all application stages with mechanical jointing tools.

Gyproc ProMix LITE Joint Cement



17 litre tubs

Characteristics

An alternative ready-mixed jointing material, with improved workability, lower shrinkage and easier sanding than Gyproc Ready Mix Joint Cement.

Application

Used in the traditional 3-stage jointing process.

Gyproc Easi-Fill



10kg bags

Characteristics

A combined setting and air-drying gypsum based material for bulk filling and finishing of joints. High coverage rate and minimal drying shrinkage allows application in only two coats. Easy to mix, apply and sand, with 90 minutes working time and the second (final) coat can be applied after 120 minutes.

Application

Used in the 2-stage method of plasterboard jointing.

Gyproc Easi-Fill 45



10kg bags

Characteristics

A combined setting and air-drying gypsum based material for bulk filling and finishing of joints. High coverage rate and minimal drying shrinkage allows application in only two coats. Easy to mix, apply and sand, with 45 minutes working time and the second (final) coat can be applied after 70 minutes.

Application

Used in the 2-stage method of plasterboard jointing.

Gyproc Joint Filler



12.5kg bags

Characteristics

A gypsum based setting material for bulk and secondary filling of plasterboard joints. A low shrinkage product for hand application with 90 minutes working time.

Application

Used in stage 1 and 2 of the 3-stage traditional method of plasterboard jointing.

Gyproc Joint Tape



150 metre rolls

Characteristics

Paper tape with centre crease, chamfered edges and spark perforations, for easy use in internal angle joints. Provides excellent crack-resistance.

Application

Designed for reinforcing flat joints and internal angles in both manual and mechanical jointing systems. Also used for joint reinforcing plaster finishes to plasterboard.

Gyproc Corner Tape



30 metre rolls

Characteristics

Paper joint tape bonded to two corrosion resistant metal strips, for manual application only. Supplied in a cardboard dispenser.

Application

For reinforcing external angles in plasterboard construction. Also ideal for internal or external angles that are not 90°.

Gyproc Drywall Primer

10 litre tubs



Characteristics

A general-purpose plasterboard primer, for brush or roller application.

Application

Provides an ideal surface for decoration with most paints and wall coverings.

Gyproc Drywall Sealer

10 litre tubs



Characteristics

A specially formulated sealer which provides vapour control and a superior, durable finish when applied in two coats.

Application

Suitable for decoration with paints and most wall coverings. A single coat protects the board surface from subsequent steam stripping. Applied with a brush or roller.

Gyproc Sealant



0.93 litre cartridge

0.38 litre cartridge

Characteristics

An acrylic sealant and adhesive.

Application

Used for sealing air gaps in British Gypsum systems to maintain optimum acoustic performance. Also used for fixing Gyproc plasterboards in the British Gypsum **DriLyner RF** system, and Gyproc ThermalLine laminates in the British Gypsum **DriLyner MF** system.

Gyproc Soundcoat Plus



25kg bags

Characteristics

Gypsum-based parge coat material.

Application

Designed for application to masonry party walls, prior to drylining, to improve acoustic performance by sealing airpaths (through cracks and block permeability).

Used in Robust Detail wall constructions.

Gyproc Dri-Wall Adhesive



25Kg bags

Characteristics

A general-purpose gypsum-based adhesive.

Application

For use in British Gypsum **DriLyner** systems, on high, medium or low suction backgrounds.

Gyproc Control Joint



47mm wide x 3048mm length

Characteristics

Pre-formed galvanised metal strip.

Application

Used to form joints in drywall systems to accommodate expansion or contraction of up to 7mm.

Gyproc FireStrip



Length
mm

3600

Characteristics

A soft extruded linear intumescent gap sealer, to maintain fire resistance.

Application

Designed to be used with British Gypsum **GypWall** metal framed systems as part of the deflection head detail.

Gyproc Drywall Metal Angle Bead



25mm x 25mm,
3000mm lengths

Characteristics

Perforated galvanised metal bead.

Application

For reinforcing external 90° angles where maximum protection is required.

Gyproc Drywall Archbead

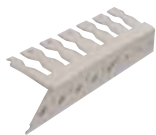

25mm x 25mm,
3000mm lengths

Characteristics

Extruded uPVC profile with equal 25mm legs.

Application

The special design allows for curving around arches and reveals down to 250mm minimum radius.

Gyproc Drywall Metal Edge Bead



12.5mm
2400mm or 3000mm lengths

15mm
3000mm lengths

Characteristics

Galvanised steel channel. Asymmetric profile with one perforated leg and pre-formed aris to accommodate jointing material.

Application

Used to protect exposed plasterboard edges and form a defined edge to plasterboard area.

Gyproc Drywall Plastic Edge Bead

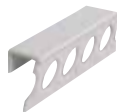

12.5mm, 3000mm lengths

Characteristics

Extruded uPVC channel. Asymmetric profile with one perforated leg and pre-formed aris to accommodate jointing material.

Application

Used to protect exposed plasterboard edges and form a defined edge to plasterboard areas.

Fixings

Our range of fixing products cater for every drywall need, ensuring simple yet secure fixing of plasterboard and metal framing.

The range includes Gyproc screws, engineered for board-to-metal, board-to-timber or metal-to-metal fixing; high performance screws for use with the British Gypsum **FireCase** encasement system and special Gypframe fixings for ceiling, lining and floor systems.



Fixings index

Gyproc fixing products

Gyproc Drywall Screws	540
Gyproc Collated Drywall Screws	540
Gyproc Drywall Timber Screws	541
Gyproc Collated Drywall Timber Screws	541
Gyproc Jack-Point Screws	542
Gyproc Wafer Head Drywall Screws	542
Gyproc Wafer Head Jack-Point Screws	543
Gyproc Nailable Plugs	543

Glasroc fixing products

Glasroc FireCase Screws	544
-------------------------	-----

Gypframe fixing products

Gypframe MF11 Nut and Bolt	544
Gypframe GL11 GypLyner Anchors	545
Gypframe SIF5 Floor Screws	545

Gyproc Drywall Screws



Characteristics

Corrosion resistant self-tapping zinc plated steel screws with countersunk cross-heads. Supplied with screw driver bits.

Application

Ideal for fixing 'C' studs (and associated framing) up to 0.79mm thick and 'I' stud framing up to 0.5mm thick. The length of screw selected for a given boarding configuration should be sufficient to give a nominal 10mm penetration into metal framing.

Length
mm

22
25
32
36
42
50
60
75
90

Gyproc Collated Drywall Screws



Characteristics

Corrosion resistant self-tapping zinc plated steel screws with countersunk cross-heads. Strips of 50 Collated Drywall Screws supplied in boxes of 1000 screws (20 strips).

Application

Ideal for fixing 'C' studs (and associated framing) up to 0.79mm thick and 'I' stud framing up to 0.5mm thick. The length of screw selected for a given boarding configuration should be sufficient to give a nominal 10mm penetration into metal framing.

Length
mm

25
36
42
50

Gyproc Drywall Timber Screws



Characteristics

Corrosion resistant self-tapping zinc plated steel screws with countersunk cross-heads. Supplied with screw driver bits.

Application

Ideal for fixing plasterboards to timber framing. The length of screw selected for a given board configuration should be sufficient to give a nominal 25mm penetration into timber framing.

Length mm
32
38
41
51
60

Gyproc Collated Drywall Timber Screws



Characteristics

Corrosion resistant self-tapping zinc plated steel screws with countersunk cross-heads. Strips of 50 Collated Drywall Timber Screws supplied in boxes of 1000 screws (20 strips).

Application

Ideal for fixing plasterboards to timber framing. The length of screw selected for a given board configuration should be sufficient to give a nominal 25mm penetration into timber framing.

Length mm
38
41
51

Gyproc Jack-Point Screws



Characteristics

Corrosion resistant, self-drilling zinc plated steel screws with countersunk cross-heads. The length of the screw selected for a given boarding configuration should be sufficient to give a nominal 10mm penetration into steel framing. Supplied with screw driver bits.

Application

Ideal for fixing plasterboards to stud framing 0.8mm thick or greater and 'I' Studs greater than 0.55mm thick.

Length
mm

25
35
41
60

Gyproc Wafer Head Drywall Screws



Characteristics

Corrosion resistant self-tapping zinc plated steel screws with wafer cross-head. Supplied with screw driver bits.

Application

Ideal for metal-to-metal fixing up to 0.79mm thick and 'I' stud framing up to 0.5mm thick.

Length
mm

13

Gyproc Wafer Head Jack-Point Screws



Characteristics

Similar to Gyproc Wafer Head Screws, but with self-drilling points. Supplied with screw driver bits included.

Application

Ideal for metal to metal fixing 0.8mm thick or greater and 'I' studs greater than 0.55mm thick.

Length mm
13

Gyproc Nailable Plugs



Characteristics

Combination of masonry nail and plastic wall fixing with expanding tip and countersunk head.

Application

Designed for secondary fixing of Gyproc ThermoLine laminates to masonry backgrounds.

Length mm
60
80
110

Glasroc FireCase Screws



Characteristics

The screws have a unique head design that countersinks into the board allowing easy fixing.

Application

Specifically designed for the fixing of Glasroc FireCase s specialist board in the British Gypsum **FireCase** system.

Length
mm

40
50
58
70

Gypframe MF11 Nut and Bolt



Characteristics

Designed for securing Gypframe MF8 Strap Hanger to Gypframe MF12 Soffit Cleat.

Application

For use in the British Gypsum **CasoLine MF** ceiling system.

Length
mm

6 x 12mm

Gypframe GL11 GypLyner Anchors



Characteristics

Hammer-in fixing with wide flange to avoid the need for a separate washer.

Application

Designed especially for fixing Gypframe GL2 or GL9 Brackets to masonry walls and concrete soffits, subject to loading.

Length
mm

40

Gypframe SIF5 Floor Screws



Characteristics

Electro-zinc plated, self-tapping screws with countersunk heads.

Application

For use in the **GypFloor SILENT** acoustic floor system. Suitable for fixing timber flooring through Gyproc Plank into Gypframe SIF Floor Channel flange.

Length
mm

55

Metal components

Gypframe metal components provide the backbone for all British Gypsum tested and warranted wall, ceiling, lining and encasement systems.

Precision engineered using the unique UltraSTEEL[®] rigidisation process, Gypframe studs, channels and associated components offer greater strength than other metal components of the same gauge, yet are equally lightweight and easy to handle. Their superior screw-fixing and retention properties ensure that lining boards are quickly, accurately and securely anchored, for guaranteed system performance.



Metal components index

Gypframe studs

'C' Studs	549
AcouStuds	549
'I' Studs	550

Gypframe channels

Standard Floor & Ceiling Channels	550
Deep Flange Floor & Ceiling Channels	551
Extra Deep Flange Floor & Ceiling Channels	551
CasoLine MF ceiling channels & accessories	552
GypLyner channels & accessories	553-554
ShaftWall starter channels & accessories	555
GypFloor SB steel battens & accessories	556
GypFloor SILENT channels & accessories	557
Fixing channels	557
GypWall RAPID dB Plus studs and channels	558
FlameLyner components	559
CurveLiner channel	559

Gypframe steel angles

Steel angles	560
--------------	-----

Gypframe specialist profiles

Board jointing components	561
Sound insulating bars	561
Skirting plate	562
Security sheet	562

Gypframe clips, brackets and accessories

Acoustic brace	563
Acoustic hangers	563
Staggered stud clips	564

Gypframe reference codes and abbreviations

The first two or three digits refer to the component width, the letters refer to the component type and the last two digits indicate metal thickness in mm, e.g. 60 I 50 refers to 60mm 'I' stud 0.50mm gauge or equivalent. Most components are manufactured using the patented UltraSTEEL® process, giving equivalent system performance to systems using metal of heavier gauges.

Key	Component	Flange dimension mm
S	'C' Stud	32 / 34 (GWR studs have 36mm flanges)
I	'I' Stud	38
AS	AcouStud	42 (43mm stud), 41 & 44 (70 & 146mm stud)
C	Standard Floor & Ceiling Channel	32 (GWR3 channel and 50 C 50 have 29mm legs)
DC	Deep Flange Floor & Ceiling Channel	50
EDC	Extra Deep Flange Floor & Ceiling Channel	70
JC	J Channel	50 / 70
SC	Starter Channel	32
FC	Fixing Channel 100mm web	9.5 (99 FC 50) , 15 (150 FC 90)
EDCL	CurveLiner Channel	70
T	Tabbed	-

Metal thickness

50 = 0.50mm	80 = 0.80mm
55 = 0.55mm	90 = 0.90mm
60 = 0.60mm	10 = 1.00mm
65 = 0.65mm	12 = 1.20mm
70 = 0.70mm	15 = 1.50mm

Gypframe 'C' Studs



Application

Used as the vertical support in wall framing, these products are available in a range of widths, lengths and thicknesses depending on requirements for strength, height, impact resistance and sound insulation.

Available length mm

48 S 50 'C' Stud[†]	2400, 2700, 3000, 3300, 3600
60 S 50 'C' Stud[†]	3000, 3600
70 S 50 'C' Stud[†]	2400, 2700, 3000, 3300, 3600, 4200
70 S 60 'C' Stud[†]	3600, 4200
92 S 50 'C' Stud[†]	3600, 4200
92 S 60 'C' Stud[†]	4200
92 S 10 'C' Stud[†]	3600, 4200
146 S 50 'C' Stud[†]	2400, 2700, 3000, 3600, 4200
146 S 60 'C' Stud[†]	3600, 4200

Gypframe AcouStuds



Application

AcouStuds can be used to upgrade the acoustic performance of 43mm, 70mm, 92mm and 146mm wall systems.

Available length mm

43 AS 50 AcouStud[†]	2395, 2695
70 AS 50 AcouStud[†]	2400, 2700, 3000, 3600, 4200
92 AS 50 AcouStud[†]	3600, 4200
146 AS 50 AcouStud[†]	2700, 3000, 3600

[†] Bespoke lengths are available for these products, subject to a minimum order quantity.

Gypframe 'I' Studs

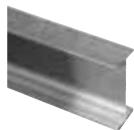

Application

These studs are the strongest available in the Gypframe range. They allow for increased height and provide ultimate impact resistance. Commonly used in ShaftWall, GyLyner **WL** and some GypWall systems.

	Available length mm
48 I 50 'I' Stud¹	2700, 3000
60 I 50 'I' Stud¹	2700, 3600
60 I 70 'I' Stud	3600, 4200
70 I 50 'I' Stud¹	3600, 4200
70 I 70 'I' Stud¹	3600, 4200
92 I 90 'I' Stud¹	3600, 5000, 6000
146 I 80 'I' Stud¹	5000, 6000
146 TI 90 Tabled 'I' Stud¹	5000, 6000

¹ Bespoke lengths are available for these products, subject to a minimum order quantity.

Gypframe Standard Floor & Ceiling Channels



Application

Designed for securing wall studs at floor and ceiling junctions.

	Available length mm
50 C 50	3600
62 C 50	3600
72 C 50	3600
94 C 50	3600
148 C 50	3600

Gypframe Deep Flange Floor & Ceiling Channels

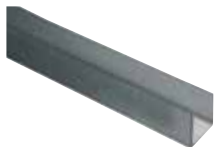

Application

Designed for situations where deflection, improved impact resistance and easier skirting fixing are required.

Available length mm	
50 DC 60	3600
62 DC 60	3600
72 DC 60	3600
94 DC 60	3600
148 DC 60	3600

Gypframe Extra Deep Flange Floor & Ceiling Channels

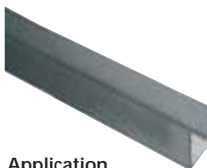

Application

Designed for situations where increased deflection, improved impact resistance and easier skirting fixing are required.

Available length mm	
50 EDC 70	3600
72 EDC 80	3600
94 EDC 70	3600
148 EDC 80	3600

CasoLine MF ceiling channels and accessories

These channels and associated accessories are designed for providing seamless suspended ceilings that can be either flat or curved.

MF5 Ceiling Section¹

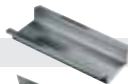

MF6 Perimeter Channel



MF7 Primary Support Channel¹

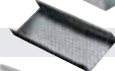

MF7C Curved Support Channel²



MF8 Strap Hanger



MF9 Connecting Clip



MF11 Nut and Bolt



MF12 Soffit Cleat



Dimensions mm

3600

3600

3600

3600

1 coil

25 metre

Box 200

2.65mm gauge

Box 200

6 x 12mm

Box 100

27 x 37 x 25 x 1.6mm

¹ Bespoke lengths are available for these products, subject to a minimum order quantity.

² Bespoke radius available, minimum order is 108 linear metres (30 lengths). Weight of 1.7kg per linear metre.

GyLyner channels and accessories

This range of channels and accessories is designed especially for plasterboard linings on masonry walls, concrete soffits, timber joists, and the encasement of steel columns and beams.

GL1 Lining Channel¹

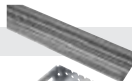

GL2 Bracket (supplied flat)



GL3 Channel Connector



GL5 Timber Connector



GL6 Timber Connector



GL8 Track

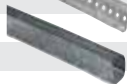

Length
mm

2400, 2700, 3000, 3600

Box 100

195

Box 50

-

Box 200

70

Box 100

170

3600

¹ Bespoke lengths are available for these products, subject to a minimum order quantity.

GypLyner channels and accessories (cont'd)

This range of channels and accessories is designed especially for plasterboard linings on masonry walls, concrete soffits, timber joists, and the encasement of steel columns and beams.

GL9 Bracket (supplied flat)



GL10 GypLyner Steel Framing Clips



GL11 GypLyner Anchors



GL12 Bracket (supplied flat)

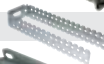

MF10 Channel



Length
mm

Box 100

295

Box 100

-

Box 100

-

Box 100

395

2800

ShaftWall starter channels and accessories

This range of channels and compatible accessories is designed especially for the high performance ShaftWall system, providing guaranteed floor, wall, head and retaining support.

60 SC 55 Starter Channel[†]



62 JC 70 'J' Channel[†]



70 SC 70 Starter Channel[†]



92 SC 90 Starter Channel[†]



146 TSC 90 Tabbed Starter Channel[†]



G102 Retaining Channel[†]



G105 Retaining Channel[†]



G108 Retaining Clips



G109 Retaining Clips



G110 Retaining Channel[†]



Length
mm

3600

3600

3600, 4200

5000, 6000

5000, 6000

2400

2400

Box 100

-

Box 100

-

2400

[†] Bespoke lengths are available for these products, subject to a minimum order quantity.

GypFloor sb steel battens and accessories

Battens and associated components which make up the GypFloor sb system, for use with both timber and masonry separating floors.

50 SB 65 Steel Batten¹



70 SB 65 Steel Batten¹



SB3 Flanking Strip



SB4 Levelling Cradle



SB5 Levelling Packer

Length
mm

1800

1800

10 metre

-

-

¹ Bespoke lengths are available for these products, subject to a minimum order quantity.

GypFloor SILENT channels and accessories

Providing support for the GypFloor SILENT acoustic floor system, these channels come with an integral neoprene acoustic isolator.

SIF1 Floor Channel

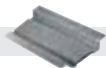

SIF2 Floor Channel



SIF4 Floor Channel



SIF5 Floor Screws



Length
mm

2000

2000

2000

Box 1000

55

Fixing channels

Used for a variety of applications including the provision of support for wall fixtures to studs and for cross bracing on twin framed walls.

99 FC 50 Fixing Channel



150 FC 90 Fixing Channel



Service Support Plate



Length
mm

2400

1194

Box 100

130

GypWall RAPID dB Plus studs and channels

These studs, channels and accessories are designed to be used together to form the GypWall RAPID dB Plus housing partition.

43 AS 50 AcouStud

70 AS 50 AcouStud

GWR2 Nogging Channel 43mm

GWR3 Floor & Ceiling Channel (45 C 50)



Length
mm

2395, 2695

2400, 2700, 3000, 3600, 4200mm

896

2400

FlameLynr components

For FlameLynr fire resisting industrial wall and roof lining system, giving up to 120 minutes fire resistance to industrial buildings.

GT1 Main 'T'



Length
mm

3600

GT2 Cross 'T'



603

GT3 Spring Wedge



Box 1000

-

GT4A Bracing Strap



300

GT4B Bracing Strap



450

GT5 Steel Angle (24mm x 24mm x 90°)



3000

CurveLiner Channel

A patented version of Extra Deep Flange floor and ceiling channel with a slotted flexible design, making it easy for the installer to set-out and build curved walls.

72 EDCL 80 CurveLiner Channel

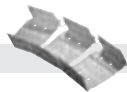

Length
mm

2000

Gypframe steel angles

Widely used in framed construction to provide support, protection, fixing and additional strength to wall, ceiling and encasement framing.

GA1 Steel Angle (25 x 25 x 0.5mm)



GA2 Steel Angle (25 x 25 x 0.7mm)



GA3 Steel Angle (19 x 32 x 0.7mm)



GA4 Steel Angle (25 x 50 x 0.7mm)



GA5 Internal Fixing Angle (60 x 60 x 0.5mm)

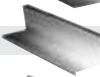

GA6 Splayed Angle (85 x 85 x 0.5mm)



Length
mm

2900

3200

3200

3660

3600

2400, 3600

Gypframe board jointing components

A range of products used to support horizontal plasterboard joints.

GFS1 Fixing Strap (70 x 0.5mm)

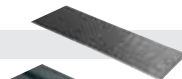

GFT1 Fixing 'T' (50 x 0.5mm)

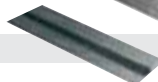

Length
mm

2400

2400

Gypframe sound insulating bars

These specially engineered products are used to optimise acoustic performance in wall and ceiling systems (RB1) where they are also used to eliminate nail popping (RB2).

RB1 Resilient Bar



RB2 SureFix Bar



Length
mm

3000

3000

Gypframe skirting plate

Specially designed products for use with thermal laminates to provide a fixing for skirtings.

G106 Skirting Plate



Depth
mm

Box 100

12.5

Gypframe security sheet

Engineered sheet for use in the cavity of the GypWall secure system to provide additional resistance to determined attack.

Security Sheet

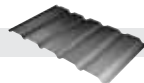

Dimensions
mm

3000 x 1070

Gypframe acoustic brace

Specially engineered product to optimise acoustic performance on the GypWall AUDIO system in high performance applications such as cinemas.

GAB3 Acoustic Brace



Length
mm

Box 25

459

Gypframe acoustic hangers

Resilient hangers used in conjunction with CasoLine MF ceiling system and timber joist ceilings and floors for increased acoustic performance.

GAH1 Acoustic Hanger



Length
mm

Box 100

35

GAH2 Acoustic Hanger



Box 100

70

Gypframe staggered stud clips

Clips for use in the GypWall STAGGERED acoustic partition system for positioning and securing studs.

SC1 Spacer Clip



SC2 Spacer Clip

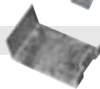

Length
mm

Box 100

-

Box 100

-

Insulation

The Isover glass mineral wool insulation range from Saint-Gobain Isover UK provides fire-safe thermal and acoustic insulation for masonry, steel frame and timber constructions, and is tested and recommended for use in British Gypsum systems.

Each of these high quality roll, batt or slab products is engineered to cost-effectively fulfil specific performance criteria. Their natural mineral base, very high percentage use of recycled material and lack of CFC, HCFC and other damaging gases, either in the products or their manufacturing process, ensures excellent environmental credentials, in addition to their energy-saving properties.



Insulation index

Isover Hi-Therm	568
Isover Hi-Cav	569
Isover Steel Frame Batts	570
Isover Cavity Barriers	571
Isover Timber Frame Batts and Rolls	572
Isover APR 1200	573
Isover Acoustic Slabs	574
Isover RD35	575
Isover Sound Deadening Floor Roll	576
Isover Acoustic Floor Slabs	577
Isover Modular Roll	578
Isover CWS	579
Isover Spacesaver, Spacesaver Plus and General Purpose Roll	580

Isover Hi-Therm

Characteristics

Foil-faced high performance glass mineral wool slab.
Euroclass A1 fire rating when classified in accordance with *BS EN 13501-1*.

Application

Installed as a partial-cavity fill in masonry external walls to provide thermal insulation.

Standards and certification

BBA approved.

Thermal conductivity

- λ 0.031W/mK (thicknesses up to and including 50mm).
- λ 0.032W/mK (thicknesses 50mm and over).

NB The thermal conductivity shown above relates to the mineral wool only. The low emissivity foil increases the thermal resistance of the adjacent airspace.



Thickness mm	Width mm	Length mm	Pack area m ²	Packs/ Pallets	m ² / Pallets
25	455	1200	9.83	15	147.45
50	455	1200	4.91	15	73.65
65	455	1200	3.82	20	76.40

Isover Hi-Cav

Characteristics

Euroclass A1 fire rating when classified in accordance with *BS EN 13501-1*. High performance mineral wool slab providing full-fill thermal insulation in masonry cavity walls.

Application

Designed to aid compliance with Building Regulations Part L1 and L2 2005 without increasing wall width or house 'foot print'.

Standards and certification

BBA approved.

Thermal conductivity

λ 0.033W/mK.



Thickness mm	Width mm	Length mm	Pack area m ²	Packs/ Pallets	m ² / Pallets
60	450	1200	7.56	15	113.40
75	450	1200	6.48	15	97.20
85	450	1200	5.40	15	81.00
100	450	1200	4.32	15	64.80

Isover Steel Frame Batts

Characteristics

Euroclass A1 fire rating when classified in accordance with *BS EN 13501-1*. Foil faced 1200mm x 1200mm mineral wool slab providing thermal and acoustic insulation in steel framed construction.



Application

Suitable for use in light-weight steel frame infill walling systems.

Thermal conductivity

 0.032W/mK.

NB The thermal conductivity shown above relates to the mineral wool only. The low emissivity foil increases the thermal resistance of the adjacent airspace.

Thickness mm	Width mm	Length mm	Batts/ Pallet	Pallet area m ²
56	1200	1200	36	51.84

Isover Cavity Barriers

Characteristics

Designed to restrict the spread of smoke and flames in all concealed cavities in masonry, steel frame and timber frame walls. Reduces flanking sound transmission in external wall cavities. Simple acoustic and fire solution at 'T' junction details including timber frame. Three colour-coded sizes for ease of identification. Long length for single, full story height applications with no joints.



Application

Designed to restrict the spread of smoke and flames in concealed cavities, particularly in cavities within external masonry or timber frame walls. Will also help to comply with acoustic requirements as required by the national Building Regulations Part E.

Width mm	Nominal mm	Barriers/ Pack
For cavity sizes 50-65mm		
300	2400	8
300	1200	13
100	1200	50
For cavity sizes 66-80mm		
300	2400	5
300	1200	10
100	1200	40
For cavity sizes 81-100mm		
300	2400	5
300	1200	10
100	1200	40

Isover Timber Frame Batts and Rolls

Characteristics

Euroclass A1 fire rating when classified in accordance with *BS EN 13501-1*. Does not shrink, slump or consolidate in normal building applications. Excellent acoustic performance.



Application

Rolls and Batts suitable for use in timber frame external and party wall constructions. The products self-support between the studs at 600mm centres and require no additional fixings. The Batts are designed so that two batts, end-to-end, will fit frames of standard domestic storey height without cutting.

Thickness mm	Width mm	Length mm	Pack area m ²	Packs/ Pallets	m ² / Pallets
-----------------	-------------	--------------	-----------------------------	-------------------	-----------------------------

Frame Roll 35

90	2x570	5.30	6.04	18	108.72
----	-------	------	------	----	--------

Frame Batt HP 32

50	570	1.175	6.03	16	96.48
----	-----	-------	------	----	-------

90	570	1.175	3.35	20	67.00
----	-----	-------	------	----	-------

Frame Batt 33

95	570	1.175	4.02	20	80.40
----	-----	-------	------	----	-------

Frame Batt 35

100	570	1.175	5.36	16	85.76
-----	-----	-------	------	----	-------

150	570	1.175	4.02	16	64.32
-----	-----	-------	------	----	-------

Timber Frame Batt 43

90	570	1.175	8.04	24	192.96
----	-----	-------	------	----	--------

140	570	1.175	5.36	24	128.64
-----	-----	-------	------	----	--------

Isover APR 1200

Characteristics

Euroclass A1 fire rating when classified in accordance with *BS EN 13501-1*. A proven high performance acoustic insulant, providing acoustic enhancement to British Gypsum warranted and performance related systems.

Application

British Gypsum metal stud partitions and wall linings.
Timber stud partition and separating walls. Timber floors.



Thickness mm	Width mm	Length mm	Pack area m ²	Packs/ Pallets	m ² / Pallets
25	2x600	20.00	24.00	24	576.00
50	2x600	13.00	15.60	24	374.40
65	2x600	10.00	12.00	24	288.00
75	2x600	12.20	14.64	24	351.36
100	2x600	9.17	11.00	24	264.00

Isover Acoustic Slabs

Characteristics

Euroclass A1 fire rating when classified in accordance with *BS EN 13501-1*. Provides thermal and acoustic benefits in wall linings and partitions. Does not shrink, slump or consolidate in normal building applications.

Application

British Gypsum metal stud partitions and wall linings.
Timber stud partition and separating walls. Timber floors.



Thickness mm	Width mm	Length mm	Pack area m ²	Packs/ Pallets	m ² / Pallets
-----------------	-------------	--------------	-----------------------------	-------------------	-----------------------------

Multi-Purpose Slabs

50	600	1200	14.40	16	230.40
75	600	1200	11.52	16	184.32
100	600	1200	7.20	16	115.20

High Performance Slabs

50	600	1200	11.52	20	230.40
75	600	1200	7.20	20	144.00
100	600	1200	5.76	20	115.20

Isover RD35

Characteristics

Foil faced acoustic slab, totally non-combustable, within Euroclass A1 rating.

Application

Installed as a partial-fill in the cavity of Robust Detail party wall construction E-WM-8 in houses and apartments, ensuring compliance with national Building Regulations Part E acoustic performance requirements without the need for sound testing on site.

Standards and Certification

Approved by Robust Details Limited.



Thickness mm	Width mm	Length mm	Pack area m ²	Packs/ Pallets	m ² / Pallets
35	455	1200	6.55	20	131.00

Isover Sound Deadening Floor Roll

Characteristics

Faced on one side with Kraft paper for additional tear strength and has a longitudinal flange for joint sealing purposes.



Application

Meets the resilient layer specification for Type 2.1C (b) concrete base intermediate separating floors, with either timber or screed floating layer, as described in the national Building Regulations.

Thickness mm	Width mm	Length mm	Pack area m ²	Packs/ Pallets	m ² / Pallets
25	1200	10.0	12.00	24	288.00

Isover Acoustic Floor Slabs

Characteristics

Mineral wool acoustic slabs providing impact sound insulation in party floors to meet national Building Regulations Part E performance requirements.

Application

Sound Deadening Floor Slab - Rigid Grade

Site tested solution: Provides the mineral wool resilient layer in a type 3.1A timber base floor without the need for additional support to the walking surface.

RD Acoustic Floor Slab

No site testing required: Meets the mineral wool resilient layer specification in Robust Detail floors E-FC-1, E-FC-2, E-FC-3 and E-FS-1 (FFT4 resilient system).



Thickness mm	Width mm	Length mm	Pack area m ²	Packs/ Pallets	m ² / Pallets
-----------------	-------------	--------------	-----------------------------	-------------------	-----------------------------

Sound Deadening Floor Slab - Rigid Grade

25	625	1200	6.00	18	108.00
----	-----	------	------	----	--------

RD Acoustic Floor Slab

25	625	1200	4.50	21	94.50
----	-----	------	------	----	-------

Isover Modular Roll

Characteristics

Euroclass A1 fire rating when classified in accordance with *BS EN 13501-1*. Does not shrink, slump or consolidate in normal applications.

Application

Suitable for providing thermal and acoustic insulation in a variety of applications where a modular 1200mm width is required.

Thermal conductivity

λ 0.043W/mK.



Thickness mm	Width mm	Length mm	Pack area m ²	Packs/ Pallets	m ² / Pallets
60	1200	15.00	18.00	24	432.00
80	1200	11.25	13.50	24	324.00
100	1200	9.17	11.00	24	264.00
150	1200	6.03	7.24	24	173.76
200	1200	3.88	4.66	24	111.84

Isover CWS

Characteristics

Euroclass A1 fire rating when classified in accordance with *BS EN 13501-1*. Water-repellent, suitable for partial and full-fill applications. Does not shrink, slump or consolidate in normal building applications.

Application

Suitable for providing thermal insulation in a variety of different masonry external wall specifications.

Standards and certification

BBA approved.

Thermal conductivity

λ 0.036W/mK.



Thickness mm	Width mm	Length mm	Pack area m ²	Packs/Pallets	m ² /Pallets
50	455	1200	10.92	20	218.40
65	455	1200	9.83	20	196.60
75	455	1200	7.64	20	152.80
85	455	1200	6.55	20	131.00
100	455	1200	5.46	20	109.20

Isover Spacesaver, Spacesaver Plus and General Purpose Roll

Characteristics

Euroclass A1 fire rating when classified in accordance with *BS EN 13501-1*. The Spacesaver products are perforated along the roll to allow full, half or third width options.

Application

Suitable for providing thermal and acoustic insulation in domestic-type pitched roofs.

Standards

- ⚠ 0.043W/mK Isover Spacesaver and Isover General Purpose Roll.
- ⚠ 0.040W/mK Isover Spacesaver Plus.



Thickness mm	Width mm	Length mm	Pack area m ²	Packs/ Pallets	m ² / Pallets
Spacesaver Roll					
100	1160	9.17	10.64	24	255.36
150	1160	6.03	6.99	24	167.76
170	1160	5.39	6.25	24	150.00
200	1160	3.88	4.50	24	108.00
Spacesaver Plus					
100	1160	7.00	8.12	24	194.88
150	1160	4.67	5.42	24	130.01
200	1160	3.50	4.06	24	97.44
General Purpose Roll					
100	2x580	9.17	10.64	24	255.36
	3x386	9.17	10.62	24	254.88
150	2x580	6.03	6.99	24	167.76
	3x386	6.03	6.99	24	167.76
200	2x580	3.88	4.50	24	108.00
	3x386	3.88	4.50	24	107.76

Plasters and plaster accessories

The UK's leading range of undercoat, finish coat, one coat and speciality plasters provide durable, high quality internal linings for all common backgrounds and building types.

Combining reliable, controlled workability for the plasterer with lifetime warranted performance for the specifier and client, the Thistle range includes premium quality bonding agents, beads and tapes - in fact, everything needed for a perfect finish, every time.

The Gyproc Tools range includes everything the building professional needs to ensure the successful installation of British Gypsum products and systems.

Selected for their quality, and developed to give exactly the performance and durability the professional expects from the essential tools and equipment of their trade, the range includes power mixing equipment and specialist plaster finishing trowels.



Plasters and plaster accessories index

Undercoat plasters

Thistle Bonding Coat	583
Thistle Hardwall	583
Thistle Tough Coat	583
Thistle Browning	583
Thistle Dri-Coat	583
Thistle X-Ray	583

Finish coat plasters

Thistle Board Finish	584
Thistle Multi-Finish	584
Thistle Uni-Finish	584
Thistle Durafinish	584
Thistle Spray Finish	584

One coat plasters

Thistle Universal One Coat	585
----------------------------	-----

Beads for solid plastering

Thistle Plaster Angle Bead	585
Thistle Plaster Stop Bead	585

Beads for skimming

Thistle Thin Coat Angle Bead	586
Thistle Thin Coat Plaster Stop Bead	586

Thistle plaster bonding agents

Thistle Bond-it	587
Thistle GypPrime	587

Thistle fibre tapes

Thistle ProTape FT50	587
Thistle ProTape FT100	587

Plasters and plaster accessories index (cont'd)

Colomix power mixing tools

CX20	588
CX40	588
CX60	588

Mixing paddles

Mixing Paddle type WK	589
Mixing Paddle type MK	589

Mixing equipment

Mixing Bath	590
Heavy Duty Mixing Bucket	590
Gyproc Mixing Tubs	590
Heavy Duty Plaster Mixing Wheel	590
Plaster Mixing Wheel	590

Premium plaster finishing trowels

Plaster Finishing Trowels	591
Stainless Steel Finishing Trowels with SoftGrip Handles	591
Carbon Steel Finishing Trowels with SoftGrip Handles	591

Stainless Steel Plaster Finishing Trowels	592
PermaShape Trowels	592

General purpose trowels

Stainless Steel Trowel	593
Carbon Steel Trowel	593

Hawks

Magnesium Hawk	594
Plasterers' Hawk	594

Darbies and feather edges

Darbies	595
Feather Edges	595

Other Gyproc plastering essentials

Plasterers' Water Brush	596
Plasterers' Scarifier	596
Sponge Float	596
Urethane Float	596

Thistle undercoat plasters¹

Thistle Bonding Coat

For low suction backgrounds (e.g. concrete, plasterboard or surfaces treated with bonding agents).



Thistle Hardwall

High impact resistance and quicker drying surface. Suitable for application by hand or mechanical plastering machine to most masonry backgrounds.



Thistle Tough Coat

High coverage, good impact resistance. Suitable for application by hand or mechanical plastering machine to most masonry backgrounds.



Thistle Browning

For solid backgrounds of moderate suction with an adequate mechanical key.



Thistle Dri-Coat

Cement based, for replastering after installation of a damp-proof course.



Thistle X-Ray

Giving protection from X-rays in medical and dental installations.



Approx coverage m ² /bag ²	Approx setting time hours	Shelf life months
2.75	1½ - 2	4
3.0	1½ - 2	4
3.5	1½ - 2	4
3.5	1½ - 2	4
3.5	N/A	6
0.35 - 0.45	1½ - 2	4

¹ Nominal bag weight 25kg.

² Coverage based on 11mm thickness for undercoat plasters (25mm for Thistle X-Ray).

Thistle finish coat plasters¹

Thistle Board Finish

For low-medium suction backgrounds (e.g. plasterboards, Thistle Dri-Coat).



Thistle Multi-Finish

For use over both undercoats and plasterboard.



Thistle Uni-Finish

A premium finish coat plaster that requires no prior preparation with PVA on the majority of backgrounds.



Thistle Durafinish

To provide improved resistance to accidental damage.



Thistle Spray Finish

Gypsum finish plaster for spray or hand application.



Approx coverage m ² /bag ²	Approx setting time hours	Shelf life months
10	1½	4
10	1½	4
10	1½	4
10	1½	4
11	1¾	4

¹ Nominal bag weight 25kg.

² Coverage based on 2mm thickness for finish coat plasters.

Thistle one-coat plasters¹

Thistle Universal One Coat

For a variety of backgrounds. Suitable for application by hand or mechanical plastering machine.



Approx coverage m ² /bag ²	Approx setting time hours	Shelf life months
---	------------------------------	----------------------

2.5	1 1/2 - 2	4
-----	-----------	---

Thistle beads for solid plastering

Thistle Plaster Angle Bead

A galvanised steel bead with expanded wings for reinforcing external angles.



Thistle Plaster Stop Bead

A galvanised steel bead with expanded wings for finishing and reinforcing plaster edges.

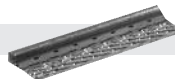

Depth mm	Length mm
-------------	--------------

-	2400
---	------

-	3000
---	------

10	2400
----	------

	3000
--	------

13	2400
----	------

	3000
--	------

¹ Nominal bag weight 25kg.

² Coverage based on 13mm thickness for one-coat plasters.

Thistle beads for skimming

Thistle Thin Coat Angle Bead

A galvanised steel 'thin-coat' bead with perforated wings for reinforcing external angles.

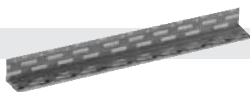

Thistle Thin Coat Plaster Stop Bead

A galvanised steel bead with perforated wings for finishing and reinforcing edges of thin-coat plaster.

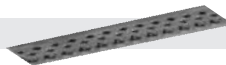

Depth mm	Length mm
-	2400
-	3000
3	2400
	3000

Thistle plaster bonding agents

ThistleBond-it

Bonding agent for pre-treatment of smooth backgrounds.



10 litre tubs

Thistle GypPrime

Suction control primer for high suction backgrounds.



11 litre tubs

Thistle fibre tapes

Thistle ProTape FT50

Self-adhesive glass fibre mesh tape for joint and repair reinforcement.



50mm x 90m rolls

Thistle ProTape FT100

Self-adhesive glass fibre mesh tape for joint and repair reinforcement.



100mm x 45m rolls

Collomix power mixing tools

CX20

The CX20 has a 2-speed gearbox and the speed control for handling the widest range of jobs with professional ease. It's rugged and powerful and designed for universal use, handling batches of up to 40 litres. Supplied complete with MK120 negative paddle.



CX40

A universal professional mixer designed to cope with high demands. It has a powerful motor, 2-speed gearbox and heavy duty drive system for reliability and a long useful life. Ideal for high viscosity mixing in batches of up to 65 litres. Supplied complete with MK140 negative paddle.



CX60

A top class machine for heavy duty and demanding professional applications. Featuring a 2-speed gearbox and sophisticated electronics, this high powered tool is suitable for continuous tough daily on-site use. Supplied complete with MK160 negative paddle.



2-Speed
control

Volts /
Watts

<400/700rpm	110v/800w
<400/700rpm	230v/1000w

<450/600rpm	110v/1200w
<450/600rpm	230v/1200w

<350/500rpm	110v/1400w
<350/500rpm	230v/1600w

Mixing paddles

Mixing Paddle type WK

Suitable for a wide range of applications, this paddle features a double mixing helix making it easy to guide around the mixing vessel. It propels the material efficiently while generating minimal stress on the machine. Suitable for all sticky and viscous materials, such as plasters, ready-mixed mortar, tile adhesive, joint filler, etc.



Mixing Paddle type MK

A particularly rugged professional mixing tool for tough day-to-day building site service. 3 mixing blades for fast results with all heavy and highly-viscous materials. It is particularly suitable for all types of mortar, plaster, screed, quartz-filled epoxy-resins, etc.



Ø mm	Shaft type
120	M14 shaft
140	M14 shaft
90	Hex shaft
120	Hex shaft
140	Hex shaft
120	M14 shaft ¹
140	M14 shaft ¹
160	M14 shaft ¹
140	M14 shaft
160	M14 shaft
100	Hex shaft
120	Hex shaft
140	Hex shaft

¹ Negative - available with either 'up' or 'down' action.

Mixing equipment

Mixing Bath

A large, 510 x 1200mm, sturdy polypropylene vessel for plaster mixing.



Heavy Duty Mixing Bucket

Tough polypropylene site bucket that will out-live the PVC alternative many times over.



Gyproc Mixing Tubs

Durable polyethylene mixing tubs with moulded handles for easier lifting and carrying. For mixing all types of plaster, jointing compounds and mortar.



Heavy Duty Plaster Mixing Wheel

Forged steel mixer for Thistle plaster, Gyproc adhesives and jointing materials. Designed to minimise material build-up on bucket walls.



Plaster Mixing Wheel

A light and effective tool for bucket-mixing plasters and jointing materials.



Ø mm	Depth mm	Capacity litre
-	-	165
-	380	30
400	300	25
450	330	40
550	420	65
-	-	-
-	-	-

Premium plaster finishing trowels

Plaster Finishing Trowels

Manufactured in high carbon steel with contoured wooden handgrips.



Thistle Finishing Trowels with SoftGrip Handles

Soft feel handles help reduce user fatigue while maintaining excellent durability.



Dimensions

11 x 4¹/₂"

11 x 4³/₄"

11¹/₄ x 4¹/₂"

11¹/₂ x 4³/₄"

12 x 5"

13 x 5"

Stainless Steel

(Plaster) 13 x 5"

(Cement) 14 x 4³/₄"

(Plaster) 11 x 4¹/₂"

13 x 5"

(Cement) 14 x 4³/₄"

Premium plaster finishing trowels (cont'd)

Stainless Steel Plaster Finishing Trowels

Premium quality stainless steel tools with contoured wooden handgrips.



PermaShape Trowels

Stainless steel finishing trowels with a 'ready broken-in shape' which eliminates line and ripple marks often associated with a brand new tool and enables inexperienced users to achieve a professional finish.



Dimensions

11 x 4 1/2" MXS1SS

13 x 5" MXS13SS

(Wooden
handle)

14 x 5" MPB14SS

(Durasoft
handle)

14 x 5" MPB14DSS

General purpose trowels

A range of carbon steel and stainless steel bladed trowels with banana shaped handles, combining quality and value for money.



Dimensions

Stainless Steel blade

11 x 4³/₄"

Carbon Steel blade

11 x 4³/₄"

13 x 4³/₄"

(with easy grip handle) 11 x 4³/₄"

Hawks

Magnesium Hawk

A quality lightweight tool manufactured in magnesium for minimum user fatigue.

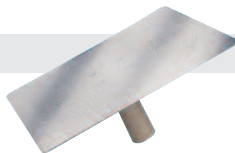

Plasterers' Hawk

Light aluminium alloy with detachable handle and rubber callous guards.



Dimensions

14 x 14"

13 x 13"

325 x 325mm

300 x 300mm

Darbies and feather edges

Darbies

Extruded aluminium with detachable handles and rubber callous guards, adjustable for span.



Feather Edges

Lightweight aluminium profile for spreading large areas of Thistle plasters to a ruled and planed surface. Helps eliminate slacks and hollows.



Dimensions

4'

6'

1800mm

2500mm

3000mm

Other Gyproc plastering essentials

Plasterers' Water Brush

Specially designed to tolerate prolonged exposure to water and exclusively hand crafted for Gyproc Tools by a specialist manufacturer. It has genuine pig bristles and the handle is of close-grained, treated hardwood with a copper ferrule secured by non-ferrous pins.



Plasterers' Scarifier

Flat, lightly-sprung tines provide a key on undercoat plasters. Dip galvanised finish.



Sponge Float

Plastic sponge float for scouring the surface of one-coat plasters prior to finishing.



Urethane Float

The ideal corrosion-proof partners for urethane hawks.



Width mm	Length mm
125	-
150	-
300	-
120	300
145	345
110	280

Access panels

Manufactured by BPB Artex, Gyproc Proflex Access Panels are purpose-designed for use in British Gypsum framed systems where there is a requirement to access services for maintenance purposes. Designs are also included for use in masonry backgrounds.

Regularly specified in commercial, industrial, public and residential buildings, they are available as wall or ceiling panels, in either standard, or a choice of performance options which are fully substantiated for use in 60 or 120 minute fire-rated constructions. They come in a range of standard sizes, with a choice of security locks and catches and in finishes to suit different applications.



Access panels index

Gyproc Profilex Standard Panel	600	Gyproc Profilex FR1 Standard Panel	603
Gyproc Profilex Sealed Panel	601	Gyproc Profilex FR1 Ceiling Panel - integrity	604
Gyproc Profilex Handi-Access Panel	601	Gyproc Profilex FR1 Ceiling Panel - protection	605
Gyproc Profilex Loft Hatch Panel	602	Gyproc Profilex FR2 Performance Panel	605

Access panels locking and frame types

There are four standard locking types:

- **Budget** - basic lock operated by a 8mm square open drive, used on the majority of panels where low security locking is required.
- **Tamper proof** - Used where a medium level of security is required. Needs a key to open but the key will open any tamper proof lock.
- **3-point** - operates as budget lock but locks to the side and, by the use of shoot bolts, to the top and bottom of the frame. Used on 120 minute fire-rated access panels.
- **Touch catch** - operated by pushing the door near the touch catch, which then springs slightly open. Used on loft hatches.

There are three frame types:

- **Beaded frame** - used in new-build where board is taped and jointed, or skim finished. Panels are painted etch primer white for on-site paint decoration.
- **Picture frame** - used where supporting construction is already built. The frame is visible after installation. Panels are factory painted gloss powder coat white.
- **Plaster frame** - Used where panels are installed in walls to be plastered (13mm overall two coat plaster). Panels are painted etch primer white for on-site paint decoration.



Beaded frame



Picture frame



Plaster frame

Gyproc Profilex Standard Panel

Characteristics

A non fire-rated panel manufactured in zinc coated mild steel and finished etch primer or powder coat white.

Application

For use in ceiling and wall constructions.

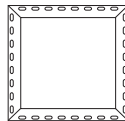
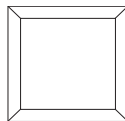
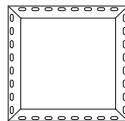

Panel size ¹ mm	No. of locks	Weight kg
-------------------------------	-----------------	--------------

Beaded frame

with budget lock

300 x 300	1	3
300 x 600	1	4
450 x 450	1	5
550 x 550	1	6
550 x 900	2	9
550 x 1200	2	13

Picture frame

with budget lock

300 x 300	1	3
450 x 450	1	5
550 x 550	1	6

Plaster frame

with budget lock

550 x 550	1	6
-----------	---	---

¹ Where panels are manufactured 550mm x 550mm, this is to suit framing at 600mm centres. The panel size dimensions are written with the hinge side dimension last i.e. 550 x 1200mm panel is 1200mm on hinge side.

Gyproc Profilex Sealed Panel

Access panels - non fire-rated

Characteristics

A flush metal faced panel manufactured in zinc coated mild steel and finished etch primer.

Application

For use in plasterboard walls and ceiling constructions, in areas of high humidity or dust free environments.

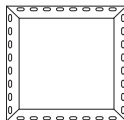

Panel size mm	No. of locks	Weight kg
------------------	-----------------	--------------

Beaded frame with tamper proof lock		
450 x 450	1	6

Gyproc Profilex Handi-Access Panel

Access panels - non fire-rated

Characteristics

A plastic panel.

Application

Used on plasterboard or other lined walls in a multitude of environments, where there is a need to access plumbing, valves, lighting devices, fuse boxes, vents and duct work.

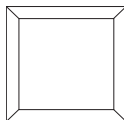

Picture frame with no lock		
150 x 235	0	1
300 x 300	0	1

Gyproc Profilex Loft Hatch Panel

Access panels - non fire-rated

Characteristics

A concealed flush metal faced panel for residential applications with no visible framing after installation. Finished in etch primer ready for decoration.

Application

For use in residential applications.

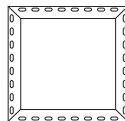

Panel size ¹ mm	No. of locks	Weight kg
-------------------------------	-----------------	--------------

Beaded frame with Loft Hatch Panel²

540 x 540	2	7
800 x 540	2	10

¹ Where panels are manufactured 550mm x 550mm, this is to suit framing at 600mm centres. The panel size dimensions are written with the hinge side dimension last i.e. 550 x 1200mm panel is 1200mm on hinge side.

² Manufactured to accept ladders (not supplied).

Gyproc Proflex FR1 Standard Panel - Integrity only (both directions)

Access panels - 60 minute fire-rated

Characteristics

A 60 minute fire-rated flush metal faced panel manufactured in treated zinc coated steel and finished etch primer or powder coated white.

Application

For use in wall constructions.

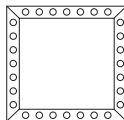
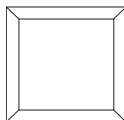
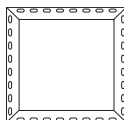

Panel size ¹ mm	No. of locks	Weight kg
Beaded frame with budget lock		
300 x 300	1	6
300 x 600	1	7
450 x 450	1	8
550 x 550	1	13
550 x 900	2	20
550 x 1200	2	26
Picture frame with budget lock		
550 x 550	1	13
Plaster frame with budget lock		
550 x 550	1	13

¹ Where panels are manufactured 550mm x 550mm, this is to suit framing at 600mm centres. The panel size dimensions are written with the hinge side dimension last i.e. 550 x 1200mm panel is 1200mm on hinge side.

Gyproc Profilex FR1 Ceiling Panel - Integrity only

Access panels - 60 minutes fire-rated

Characteristics

A 60 minute fire-rated flush metal faced panel, manufactured in treated zinc coated steel and finished in etch primer. The Gyproc Profilex FR1 Ceiling Panel is equipped with a controlled action device to ensure safe operation.

Application

For use in ceiling constructions only.

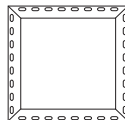

Panel size mm	No. of locks	Weight kg
Flush metal faced with beaded frame and budget lock		
300 x 300	1	3
450 x 450	1	6
600 x 300	1	5
600 x 600 ¹	1	10
600 x 900	2	15
600 x 1200	2	20

¹ Also available with picture frame

Gyproc Profilex FR1 Ceiling Panel Protection to steel beams

Access panels - 60 minute fire-rated

Characteristics

A 60 minute fire-rated panel manufactured in zinc coated mild steel and finished etch primer. Door faced with plasterboard and edged with beaded trim. The Gyproc Profilex FR1 Ceiling Panel is equipped with a controlled action device to ensure safe operation.

Application

For use in ceiling constructions only.

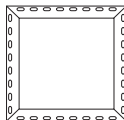

Gyproc Profilex FR2 Performance Panel - Integrity only

Access panels - 120 minute fire-rated, integrity only from one side

Characteristics

A 120 minute fire-rated flush metal faced panel manufactured in zinc coated mild steel and finished etch primer.

Application

For use in British Gypsum ShaftWall™ or wall lining systems.

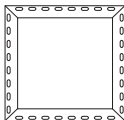

Panel size mm	No. of locks	Weight kg
------------------	-----------------	--------------

Plasterboard faced with beaded frame and budget lock

300 x 300	1	4
450 x 450	1	8
600 x 300	1	7
600 x 600	1	13
600 x 900	2	20
600 x 1200	2	26

Plasterboard faced with beaded frame and budget lock

550 x 550	1	15
-----------	---	----

Ceilings

Arteco ceiling products offer performance and flexibility, allowing the designer to create simply stunning ceilings that complement and enhance the interior building environment.

With their eye-catching designs, the Arteco tile, plank and board ranges combine high levels of acoustic performance with the durability and fire safety of gypsum. They are ideal for all types of buildings, from schools, hospitals and hotels, to modern office and residential developments.



Casoprano

With six appealing designs - smooth, textured or perforated - Casoprano is an adaptable range of pre-finished white gypsum suspended ceiling tiles.

Durable choice

Casoprano, manufactured from gypsum board, is the durable alternative to wet felted mineral fibre tiles. It combines the proven fire safety and strength of gypsum with a choice of contemporary decorative finishes designed for a wide range of buildings and applications.

Improved speech clarity

Casoprano tiles can be used to give high levels of speech clarity in classrooms, where the acoustic environment has a significant impact on the performance of the teacher and student.

Description

A range of pre-finished white gypsum tiles in a choice of smooth, textured or perforated finishes.

For installation guidance, see the British Gypsum Ceilings Installation Guide.

For more information please refer to the British Gypsum website www.british-gypsum.com

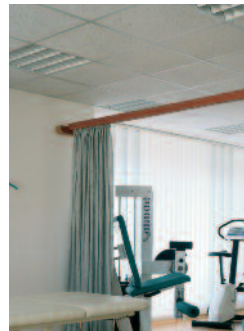

Gyptone - tiles and planks

The Gyptone range of suspended ceiling tiles and planks provide interior designers with an innovative and exciting combination of design and performance, and with limitless options for building interiors.

Acoustics and aesthetics

Gyptone unites distinctive designs, gypsum's durability and superb sound absorption characteristics. It also offers easy maintenance and enables redecoration without affecting acoustic performance. With four attractive geometric patterns - SIXTO, QUATTRO, POINT and LINE - which can be used in conjunction with unperforated BASE, Gyptone's range gives designers and users an ideal acoustic environment with exciting aesthetic appeal.

Description

Pre-finished geometric design, perforated high performance tiles and planks with integral sound absorbent tissue backing.

For installation guidance, see the British Gypsum Ceilings Installation Guide.

For more information please refer to the British Gypsum website www.british-gypsum.com

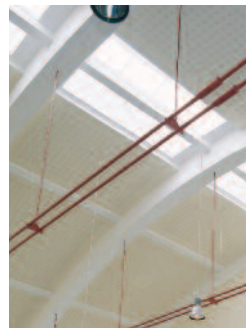
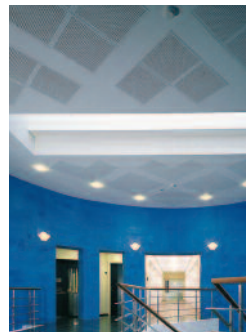

Gyptone - boards

The Gyptone range of boards brings a new creative freedom to ceiling and wall lining design, whether the concept calls for sweeping yet elegant links between open areas, or for a simple, natural transition between rooms. Gyptone's attractive boards for flat or curved surfaces can be decorated and redecorated without affecting acoustic performance, and add gypsum's fire safety and durability for total aesthetic appeal.

The sound choice

With their stylish perforated patterns and special acoustic tissue bonded to the back face, Gyptone boards bring a feeling of space to offices, shops, restaurants and other buildings where acoustic ambience is important.

Description

Geometric design, perforated gypsum boards with an integral sound absorbent tissue backing. Provide jointless finish ready for decoration on site.

For installation guidance, see the British Gypsum Ceilings Installation Guide.

For more information please refer to the British Gypsum website www.british-gypsum.com



Rigitone

Rigitone perforated acoustic gypsum boards are designed to inspire architects with their exciting scope for seamless patterned ceiling design. A jointless ceiling system gives the aesthetic satisfaction of an homogenous surface to enhance the effect of both regular and scattered patterns. In addition, acoustic performance can be controlled by choice of surface designs, resulting in interiors with truly impressive ambience.

Seamless designs and acoustic performance

Rigitone perforated boards, with their special acoustic tissue backing, are ideal for offices, shops, restaurants and other buildings where acoustic ambience is as important as looks. The gypsum plasterboard base gives Rigitone inherent durability, whilst the boards can be redecorated time and time again without affecting acoustic performance.

Description

Gypsum boards, perforated with regular or random patterns, with sound absorbent tissue backing. Provide monolithic appearance ready for decoration on site.

For installation guidance, see the British Gypsum Ceilings Installation Guide.

For more information please refer to the British Gypsum website www.british-gypsum.com

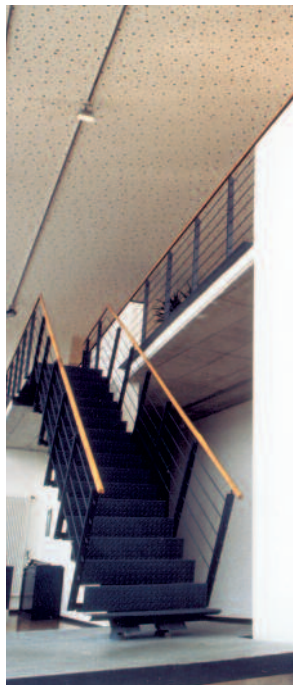

Gyprex

Gyprex is a high performance and easy maintenance vinyl faced gypsum tile that offers outstanding value for money. Its wipe-clean, long wearing surface makes it ideal for food preparation and other hygienic areas.

Clean and easy

Available in a choice of stylish finishes, Gyprex tiles are exceptionally thin and light - just 8mm thick - making them easy to cut and install. Gyprex tiles offer high performance too, being able to accommodate humidity levels up to 90% RH.

Gyprex BIO has an integral active Biocide, preventing fungal and bacterial growth and reducing the risk of contamination and infection - particularly important in hospitals and hygienic areas of buildings.

Description

A vinyl faced, wipe-clean gypsum tile particularly suitable for use in hygienic areas.

For installation guidance, see the British Gypsum Ceilings Installation Guide.

For more information please refer to the British Gypsum website www.british-gypsum.com



Decorative products

Gyproc decorative products are designed to add the finishing touch to any room, whether you are building from new, refurbishing or simply updating the decoration.

With the ever-popular Gyproc Cove or Cornice to stylise and soften wall/ceiling junctions, and Gyproc Styletrims to create interesting and imaginative design effects to plasterboard linings, dull and uninteresting rooms need never again be a problem for the building designer.

Artex decorative products go one stage further, with a complete palette of exciting and innovative products to help create warm and contemporary interior designs.

Offering a distinctive range of plaster mouldings and a variety of ceiling and wall finishes, there's everything you need to bring that extra finishing touch to a room.



Decorative products index

Gyproc Cove, Cornice and Styletrim products

Gyproc Cove	614
Gyproc Cornice	614
Gyproc Cornice Strips	615
Gyproc Cornice Battens	615
Gyproc Cove Adhesive	616
Gyproc Styletrims	617

Artex products

Artex decorative plaster cove	618
Artex decorative plaster ceiling roses	619
Artex Halo	619
Artex cove accessories	620
Artex adhesives	620
Artex texture preparation	621
Artex texture finishes	622
Artex texturing tools	623 - 625
Artex exterior finishes	625

Gyproc Cove



Size mm	Facing paper	Length mm
100	White	3000
127	Ivory	3000
		3600
		4200

Characteristics

Gypsum plasterboard moulding in traditional cove profile. Facetted back for easier location. Paper lined sections.

Application

100mm Cove ideal for most domestic applications, 127mm Cove suitable for larger rooms and commercial applications.

Gyproc Cornice

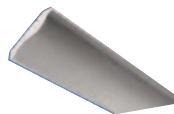

Size mm	Facing paper	Length mm
135	White	3000

Characteristics

Gypsum plasterboard moulding in classic 's' profile. Paper lined section.

Application

Gives a high quality look to any room, especially when used in conjunction with Gyproc Cornice Strips.

Gyproc Cornice Strips



Thickness mm	Width mm	Length mm
12.5	100	2400

Characteristics

Pre-cut strips of glass reinforced gypsum board.

Application

Enhance Gyproc Cove and Cornice installations to give more ornate effects.

Gyproc Cornice Battens

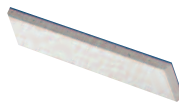

Thickness mm	Width mm	Length mm
10	25	1200

Characteristics

Pre-cut strips of glass reinforced gypsum board.

Application

Allows the installation of Gyproc Cornice over an existing profile without the need for time consuming removal of the old cove moulding.

Gyproc Cove Adhesive



Nominal bag weight	
	kg
	5
	12.5

Characteristics

Gypsum based adhesive specially formulated for good 'grab' and adhesion.

Application

Fixing of Gyproc Cove and Cornice products to most backgrounds, and filling of mitred joints.

Gyproc Styletrims

Gyproc Styletrims are primed, pre-formed aluminium trims which enable the designer to create interesting and imaginative architectural design effects with plasterboard.

BGM105 Edge Reveal

Used to create a 25mm wide x 10mm deep reveal around drylined wall perimeters, doors, glazing and skirting.



BGM106 Edge Reveal

Used to create a 12.5mm wide x 10mm deep reveal around drylined wall perimeters, doors, glazing and skirting.

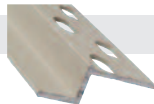

BGM119 Edge Stop

Used to create a distinctive straight edge for reveals and other drylining features.



Width	Depth mm
25	10
12.5	10
-	12.5

Artex decorative plaster cove

Moulded from hand-crafted originals

Georgian



Roman



Grecian



Adam



Size mm	Length mm	Pack Qty
127	2 x 2000	2
127	2 x 2000	2
127	2 x 2000	2
127	2 x 2000	2

Note: More options are available. Please visit www.bpbartex.com

Artex decorative plaster ceiling roses

For traditional framing of ceiling lights

Georgian



Roman



Grecian



Adam



Note: More options are available. Please visit www.bpbartex.com

Diameter
mm

Small 380

Large 540

Small 380

Large 540

Small 380

Large 540

Small 380

Large 540

Artex Halo

Lightweight ceiling rose which covers untidy light fittings whilst giving the ceiling a stylish finishing touch.

Orbit



200

Eclipse



200

Size
mm

Artex cove accessories

Cove Primer

Cove Joint and Gap Filler

Universal Mitre Block



Size

800ml

330g

-

Artex adhesives

For fixing mouldings and accessories

Multi Purpose Adhesive



Size
mm

1 Litre

2.5 Litre

5 Litre

Artex texture preparation

		Size
Sealer - Concentrated		<input type="checkbox"/> 1 Litre <input type="checkbox"/> 2.5 Litre <input type="checkbox"/> 5 Litre <input type="checkbox"/> 20 Litre
Sealer - Ready to use		<input type="checkbox"/> 1.3 Litre
Stabilex		<input type="checkbox"/> 5 Litre
Quick Start		<input type="checkbox"/> 10kg
Kraft tape		<input type="checkbox"/> 90m <input type="checkbox"/> 180m
White tape		<input type="checkbox"/> 25m <input type="checkbox"/> 90m <input type="checkbox"/> 180m

Artex texture finishes

Powder

Textured Finish - All Temperature Mix



Size

5kg

10kg

15kg

25kg

Site Finish



25kg

Ceiling Finish



25kg

Smooth-it Powder



25kg

Ready mixed

Textured Finish











5 Litre

Sealer - Ready to use



10 Litre

Artex texturing tools

		Size
Hand Mixer		-
Power Drill Mixer		-
Large Mixing Bucket		20 Litre
Caulker		200mm, 250mm, 300mm
Laying on Brush		-
Bark Foam Roller		-
Stipple Foam Roller		-
Diamond Foam Roller		-

Artex texturing tools (cont'd)

Bark Roller



180mm

Texturing Brush



-

Standard Stipple Brush



150 x 100mm, 200 x 150mm

Tradesman Stipple Brush



150 x 100mm, 200 x 150mm,
330 x 300mm

Flower Feature Comb



90mm, 170mm, 250mm, 300mm

Standard Comb



170mm

Rose Feature Comb



90mm

Artex texturing tools (cont'd)

DIY Texturing Comb

Lacer Set

Tradesman Lacer Set



Size

-

210 / 140mm

290mm

Artex exterior finishes

Hyclad



Size

Brilliant White 15kg

Cream 15kg

Magnolia 15kg

Acoustic plasterboard

A gypsum plasterboard with a higher density core than standard wallboard, and blue coloured paper liners. Used for wall lining, ceiling and partition systems where improved sound insulation is required e.g. Gyproc SoundBloc.

Angle bead

A metal or plastic angle used to reinforce external corners e.g. Gyproc and Thistle Angle Bead.

Backing coat

Undercoat plaster used as part of a two-coat plaster system e.g. Thistle Hardwall.

Bonding agent

Liquid preparation applied to the wall or ceiling surface prior to plastering to provide adhesion to challenging backgrounds e.g. ThistleBond-it.

Caulk

A joint sealing material, applied in a plastic state.

Closing-in

The operation of consolidating the surface of a final coat plaster with a finishing trowel.

Control joint

A joint which accepts movement in the form of lateral expansion or contraction. Allows relatively small movements to occur without damage to the internal surface.

Core board

A version of fire resistant and moisture resistant plasterboard with square edges and green coloured paper liners supplied in 19mm thickness. Used as an inside stud (core) board in shaft wall systems e.g. Gyproc CoreBoard.

Cove

A decorative moulding used at the wall to ceiling angle.

Cut end

End of a gypsum board showing the exposed core.

Decibel (dB)

A unit of magnitude for Sound Pressure, Sound Intensity, Sound Power and, in relation to Sound Insulation, the measurement of level reduction. The measure for impact sound insulation.

Deflection head

A special design feature at the head of a partition, which allows its integrity to be maintained while allowing movement such as floor slab or beam deflection to take place.

Dewpoint

The temperature at which air becomes saturated with water vapour and below which condensation occurs.

Door set

A complete unit consisting of a door frame and door leaf or leaves, supplied with essential hardware as a product from a single source.

Dry construction

A general term describing wall linings, ceiling linings, lightweight partitions and separating walls in board or sheet materials, either self-finished, plastered or jointed as distinct from construction with solid plaster finishes.

Drying shrinkage

Shrinkage caused by the evaporation of water.

Drylining

Creating a wall or ceiling lining using plasterboard as an internal finish instead of solid plaster treatment.

Drywall partition

Lightweight partition either self-finished, plastered or jointed as distinct from masonry construction with solid plaster finishes.

Drywall

A partition, separating wall or wall lining which uses plasterboard as a lining instead of solid plastering (can be skim plastered however).

Dual-purpose compound

Jointing compound suitable for use as a bedding compound and as a finishing compound in a jointing process e.g. Gyproc Easi-Fill.

Edge profile of plasterboard

The bound edge of a plasterboard which is traditionally square or tapered.

Edge bead

A metal or plastic bead to protect the edges of plasterboard or to form a feature e.g. Gyproc Drywall Metal Edge Bead.

Efflorescence

Formation of crystals on a surface during drying, caused by the presence of soluble salts.

Expansion joint

A permanent joint between different parts of the structure to allow relatively small movements to occur without damage to the surface.

Face

The side of the plasterboard from which the covering paper is carried round the edges e.g. the exposed side for direct decoration or plastering.

Feather-edge rule

Used for working angles or for closing-in an undercoat plaster after using a floating rule. It is of wood or metal with one edge bevelled to a thickness of about 3mm.

Final set

The point at which the plaster mix permits no movement under the trowel.

Field of board

The surface of plasterboard (as opposed to the edges or ends).

Finishing coat

The final coat in two or three-coat plasterwork e.g. Thistle Multi-Finish.

Finishing compound

Jointing material applied over the bedding compound in one or more applications and which forms the final finished surface.

Fire door

A door that provides fire resistance.

Fire resistant and moisture resistant plasterboard

A fire resistant plasterboard with water repellent and other additives in the core e.g. Gyproc FireLine MR.

Fire resistant plasterboard

A gypsum plasterboard with greater fire protection properties than standard plasterboard e.g. Gyproc FireLine.

Fixed partition

A partition which cannot be demounted without destroying, partially or totally, the integrity of the components.

Flanking sound

The structure-borne transmission of sound between adjacent rooms or spaces which bypasses the obvious dividing barriers.

Float

Tool used in plasterwork to smooth and level the plaster surface.

Floating coat

The undercoat immediately preceding the final coat.

Floating floor

Part of a composite floor construction whereby the upper surface membrane (possibly a concrete screed or timber deck) is independently isolated (floated) from the lower structural floor by the use of a resilient underlay, an array of flexible pads, spring isolators or battens.

Floating rule

For spreading large areas of Thistle plaster to a ruled and planned surface. Helps to eliminate slacks and hollows.

Framed partition

A partition consisting of a continuously supported frame with facings or infillings. It may take the form of a stud and sheet, frame and sheet or frame and panel partition
e.g. GypWall CLASSIC.

Furring

Timber or metal channels used to even-up a surface - on a wall for example, to provide a true surface to which plasterboards can be fixed e.g. Gypframe MF10 Channel.

Glass mineral wool

Mineral wool manufactured from glass, used for improved thermal or acoustic insulation e.g. Isover.

GRG board

A gypsum board having a glass fibre reinforced core and continuous glass fibre membranes just below each surface
e.g. Glasroc FireCase s and Glasroc MultiBoard.

Gypsum

Calcium sulphate dihydrate ($\text{CaSO}_4 \cdot 2\text{H}_2\text{O}$). A natural mineral deposit and the main raw material from which gypsum plaster is made.

Gypsum adhesive

A gypsum-based compound which, when mixed with water, provides an adhesive for use in drylining systems
e.g. Gyproc Dri-Wall Adhesive.

Gypsum plank

Gypsum plasterboard 19mm thick and 600mm wide
e.g. Gyproc Plank.

Gypsum plaster, hemihydrate

Plaster, mainly of gypsum, from which approximately three-quarters of the water has been removed.
($\text{CaSO}_4 \cdot \frac{1}{2}\text{H}_2\text{O}$).

Gypsum plaster, pre-mixed lightweight

Plaster in which a lightweight aggregate has been pre-mixed dry with a hemihydrate gypsum plaster to give low density.

Gypsum plasterboard

A building board, complying with EN 520, composed of a core of aerated gypsum plaster bonded between two sheets of strong paper e.g. Gyproc WallBoard.

Hacking

The roughening of solid backgrounds by hand or mechanical means to provide a suitable key.

Hair Line crack

Crack just visible to the naked eye.

Impact resistant plasterboard

A gypsum plasterboard with a heavy duty face paper, a higher density core than standard plasterboard and additives in the core to improve impact performance e.g. Gyproc DuraLine.

Impact sound

Sound produced when short duration sources such as footsteps, door slams, etc. impact directly onto a structure.

Independent wall lining

A lining (often using related partition components), which is erected independently of the external walling e.g. **GypLyner iwL**.

Insulating drylining

Drylining using laminates composed of plasterboard and polystyrene, phenolic foam or mineral wool e.g. Gyproc ThermoLine laminates.

Joint tape

Tape which is embedded in the bedding compound to reinforce the joint e.g. Gyproc Joint Tape.

Jointing

The process of using hand or mechanical systems for achieving a flush seamless surface on dry construction, based on tapered edge plasterboard, and applicable to walls and ceilings.

Key

The roughness of a surface which enables plaster to make a mechanical bond with it.

Lath

Expanded metal mesh that is fixed to a surface to provide a mechanical key for plaster.

Masonry partition

A partition of brickwork or blockwork complete with any specified surface finishes such as a drylining or plaster.

Metal stud partition

A partition consisting of a metal stud / channel framework, lined both sides with sheet materials such as plasterboard. This is a form of stud and sheet partition e.g. **GypWall CLASSIC**.

Metal stud separating wall

A metal stud / plasterboard partition, which meets the separating wall requirements of national Building Regulations for multi-occupancy dwellings e.g. **GypWall QUIET IWL**.

Moisture resistant plasterboard

A gypsum plasterboard with moisture-repellent additives in the core, which is enclosed in water-repellent green coloured paper liners e.g. Gyproc Moisture Resistant.

Nogging

Cross member between main members of a framed construction. Also known as 'dwang'.

Noise

Unwanted sound resulting in distraction and disturbance, interference with speech and stress or damage to hearing.

Panel

Decorative or functional portion of the cladding of a floor, ceiling, roof or wall, supported by a concealed or exposed frame.

Partition

A non-loadbearing vertical construction dividing space e.g. **GypWall CLASSIC**.

Pattern staining

Surface staining which sometimes occurs when the two sides of a composite structure are consistently exposed to different temperatures.

Perforated ceiling

A ceiling incorporating tile or board products available in various edge profiles and with circular, square or rectangular perforations in random or regular pattern designs, typically used in suspended ceilings to provide sound absorption e.g. **Arteco Gyptone**.

Performance partitions

Partitions which have enhanced sound insulation, fire resistance, impact resistance, or a combination of these e.g. **GypWall ROBUST** or **GypWall QUIET**.

Perlite

A lightweight aggregate produced from siliceous volcanic glass expanded by heat, used as an additive in some backing coat plasters.

Plaster key

Portion of the plaster which is pressed through metal lath and, when set, holds the plaster layer in place. Also applied to the mechanical key produced by scratching a plaster undercoat.

Plenum

An enclosed chamber, e.g. space between a suspended ceiling and the floor above.

Pricking-up

The application of the first coat of plaster on metal lathing.

Rendering coat

First coat of plaster on a wall.

Reverberation

The persistence of sound in an enclosure, due to its continued reflection or scattering from surfaces or objects, after the sound source has ceased.

Sarking board

Sheet material fixed to roof framework to contribute to weather protection, which may provide a degree of racking resistance.

Sealant

Joint sealing material, applied in a plastic state, e.g. Gyproc Sealant.

Security partitions

Constructions specifically designed to be resistant to ballistic and physical attack and explosions, such as those from letter or car bombs, etc. e.g. **GypWall secure** or **BlastWall**.

Self-drilling, self-tapping

Shank and point design of a metal screw which facilitates penetration and grip into a light gauge metal section.

Shaft wall

A partition or lining used to form fire protective enclosures to all forms of shafts including, service cores and lift shafts. It consists of multi-layers of gypsum plasterboard fixed to single or twin metal frames to give fire resistance. e.g. **ShaftWall**.

Sheathing board

Sheet material used in framed structures. Fixed to external wall framework to contribute to weather protection, it may provide a degree of racking resistance.

Skin

A single thickness of panelling or cladding or one leaf of a cavity wall. Single skin or double skin are used to describe a lining consisting of one or two skins of plasterboard.

Soffit

Any semi-exposed under-surface.

Sound absorption

Sound absorption is the loss of sound energy when striking or transmitting into a boundary surface material or obstacle, or when causing a volume of air to resonate.

Sound leakage

Airborne sound transmission via gaps or cracks around or through building elements and services that allow sound to escape from one area to another adjacent area, and thus lower the element's potential sound reduction properties.

Square edge boards

Plasterboard with a square edge profile used for textured finishes or undecorated applications, as well as being suitable to receive gypsum plaster.

Staggered metal stud partition

A partition based on a framework with alternative studs off-set within wide floor and ceiling tracks. This system is used where increased levels of sound insulation are required. Performances are higher than those achieved with a single row of stud, but lower than with twin-framed partitions e.g. **GypWall STAGGERED**.

Stone wool

Mineral wool manufactured from stone, used to improve fire resistance performance.

Stud

Vertical member in framed wall or partition.

Suction

Moisture absorption of background.

Suspended ceiling

A ceiling formed with boards or tiles fixed into (or onto) a grid with a cavity between the suspension system and the structural soffit, joists or trusses e.g. **CasoLine MF**.

Suspension system

Grid of metal sections, consisting of main and cross members, to support ceiling panels.

Tapered edge

A design of a board or sheet material applicable to plasterboard particularly and to its long bound edges to enable flush seamless jointing or plastering to be carried out in dry construction.

Thermal laminate

A laminate consisting of gypsum plasterboard with a backing of factory bonded insulation material providing enhanced thermal insulation. Used to provide insulated wall and soffit linings or ceilings e.g. Gyproc ThermaLine thermal laminates.

Three-coat work

Plasterwork with rendering, floating and finishing coats. Generally used when a very high quality finish is required.

Timber stud partition

A partition consisting of a timber frame lined on each side with materials such as plasterboard.

Undercoats

Gypsum plaster or cement render coats other than the final coat e.g. Thistle Bonding Coat.

Vapour control plasterboard

A gypsum plasterboard backed with metallised polyester for wall and ceiling linings, which enables the lining and the vapour check membrane to be fixed in one operation e.g. Gyproc WallBoard **DUPLEX**.

Vapour control layer

A material (usually a membrane) that substantially reduces the transfer of water vapour through a building element in which it is incorporated.

Vermiculite

A lightweight aggregate produced from micaceous material exfoliated by heat.

Working time

The period during which a plaster mix is workable, i.e. does not significantly stiffen.

X-ray plaster

Plaster containing barytes (barium sulphate BaSO_4) as the aggregate, which gives protection or shielding from electro-magnetic radiation e.g. Thistle X-Ray plaster.

A

Access panels	598 - 605
AcouStuds	547
Acoustic brace	561
Acoustic hangers	561
Arteco ceiling products	606 - 611
Casoprano	607
Gyprex	611
Gyptone	608 - 609
Rigitone	610
Artex decorative products	612 - 625
Adhesives	620
Cove accessories	620
Decorative Plaster Cove	618
Decorative Plaster Ceiling Roses	619
Exterior finishes	625
Halo	619
Texture preparation	621
Texture finishes	622
Texturing tools	623 - 625

B

Backing coat plasters - see Undercoat plasters	
Beads	
Drywall	534 - 535
Plaster	585 - 586
BlastWall	217
Board accessories	524 - 535
Board Finish plaster	584
Board jointing components	438 - 439
Boards	506 - 523
Bonding Coat plaster	583
Bonding compound - see Dri-Wall Adhesive	
Browning plaster	583

C

C Studs	547
CasoLine CURVE system	306 - 317
CasoLine MF ceiling channels and accessories	550
CasoLine MF system	290 - 305
CasoLine GRID system	330 - 331
Casoprano tiles	607

Ceiling systems	290 - 381	Dri-Wall Adhesive	532
Ceiling products	606 - 611	Drywall Academy	52 - 59
Channels	548 - 557	Drywall Archbead	534
Collated Drywall Screws	538	Drywall beads	534 - 535
Collated Drywall Timber Screws	539	Drywall Metal Angle Bead	534
Control Joint	532	Drywall Metal Edge Bead	535
CoreBoard	515	Drywall Plastic Edge Bead	535
Corner Tape	529	Drywall Primer	530
Cornice	614	Drywall Screws	538
Cornice Battens	615	Drywall Sealer	530
Cornice Strips	615	Drywall Timber Screws	539
Cove	614	Durafinish	584
Cove Adhesive	616	DuraLine	520
CurveLiner Channel	557	DuraLine MR	520
D		E	
Darbies	595	Easi-Fill	527
Decorative effects	472 - 485	Easi-Fill 45	528
Decorative plaster mouldings	618 - 619	Extra Deep Flange Floor & Ceiling Channels	549
Decorative products	612 - 625		
Deep Flange Floor & Ceiling Channels	549		
Dri-Coat plaster	583		
DriLyner BASIC, TL, SI, MF, RF system	240 - 259		

Gyptone products			
Boards	609		
Tiles and planks	608		
GypWall AUDIO system	180 - 189		
GypWall CLASSIC system	62 - 85		
GypWall CURVE system	110 - 117		
GypWall EXTREME system	86 - 109		
GypWall QUIET system	136 - 145		
GypWall QUIET IWL system	146 - 155		
GypWall QUIET SF system	156 - 165		
GypWall RAPID dB Plus system	118 - 135		
GypWall RAPID dB Plus studs, channels and accessories	556		
GypWall ROBUST system	62 - 85		
GypWall SECURE system	216		
GypWall STAGGERED system	166 - 179		
H			
Hawks	594		
HandiBoard	513		
Hardwall plaster	583		
Health and Safety	8 - 10		
		I	
		I Studs	548
		Insulation	564 - 579
		Insulation boards - see Thermal laminates	
		Isover	
		Acoustic Floor Slabs	575
		Acoustic Slabs	572
		APR 1200	571
		Cavity Barriers	569
		CWS	577
		General Purpose Roll	578
		Hi-Cav	567
		Hi-Therm	566
		RD35	573
		Sound Deadening Floor Roll	574
		Spacesaver Plus	578
		Spacesaver Roll	578
		Steel Frame Batts	568
		Timber Frame Batts and Rolls	570

J

Jack-Point Screws	540
Joint Cement	526
Joint Filler	528
Joint Tape	529
Jointing	436 - 449
Jointing materials	526 - 530

L

Laminates - see Thermal laminates

M

Manual handling and lifting	38 - 51
Metal components	544 - 563
Metal systems - see Systems	
Mixing equipment	589 - 590
Moisture Resistant plasterboard	513
MultiBoard	524
Multi-Finish plaster	584

N

Nailable Plugs	541
----------------	-----

O

One-coat plasters	584
-------------------	-----

P

Partitions and wall systems	62 - 239
Plank	513
Plaster accessories	585 - 597
Plaster Angle Bead	585
Plaster beads - see Beads	
Plaster bonding agents	
GypPrime	587
ThistleBond-it	587
Plaster Stop Bead	585
Plasterboard accessories	524 - 535
Plasterboards	506 - 523
Plaster skimming	428 - 435
Plaster systems	408 - 427

Plasters	580 - 584	Skirting plates	560
Primers		SoffitLine	522
Drywall Primer	530	SoffitLine system	374 - 381
GypPrime	587	Solid plastering beads - see Beads	
Projection plaster	584	Sound insulating bars	559
ProMix LITE Joint Cement	527	SoundBloc	517
ProTape	587	SoundBloc F	518
		SoundBloc MR	518
R		SoundBloc RAPID	519
Ready Mix Joint Cement	526	SoundBloc RAPID MR	519
Resilient bars	559	Soundcoat Plus	531
Rigidur H	525	SpecSure® lifetime performance warranty	60 - 61
Rigitone boards	610	Staggered Stud Clips	562
		Standard Floor & Ceiling Channels	548
S		Steel angles	558
Safe Systems of Work (SSOW)	38 - 51	Steelwork encasement systems	382 - 407
Screws	536 - 543	Studs	547 - 548
Sealant	531	Styletrims	617
Security Sheet	560		
Service installations	26 - 30		
ShaftWall starter channels and accessories	553		
ShaftWall system	190 - 215		
Skimming beads - see Beads			

Systems

CasoLine CURVE	306 - 317
CasoLine MF	290 - 305
CasoLine GRID	330 - 331
DriLyner BASIC, TL, SI, MF, RF system	240 - 259
FireCase	382 - 395
FireWall	218 - 225
FlameLyner	288 - 289
GypFloor SB	362 - 373
GypFloor SILENT	348 - 361
GypLyner ENCASE	396 - 407
GypLyner UNIVERSAL wall lining system	260 - 275
GypLyner UNIVERSAL floor and ceiling system	318 - 329
GypLyner IWL	276 - 287
GypWall AUDIO	180 - 189
GypWall CLASSIC	62 - 85
GypWall CURVE	110 - 117
GypWall EXTREME	86 - 109
GypWall QUIET	136 - 145
GypWall QUIET IWL	146 - 155
GypWall QUIET SF	156 - 165
GypWall RAPID dB Plus	118 - 135
GypWall ROBUST	62 - 85

GypWall SECURE	216
GypWall STAGGERED	166 - 179
ShaftWall	190 - 215

System warranty - see SpecSure®

T

Tapes

Corner Tape	529
Joint Tape	529
ProTape	587
Texture products and accessories	621 - 625
Thermal laminates	519 - 520
ThermaLine BASIC	521
ThermaLine PLUS	522
ThermaLine SUPER	523
Thin Coat Angle Bead	586
Thin Coat Plaster Stop Bead	586
Thin Coat Mini Mesh Bead	586
Thistle plaster products	580 - 587
ThistleBond-it	587

Tiling	450 - 471
Timber joist	332 - 347
Timber stud	226 - 239
Tough Coat plaster	583
TriLine	521
Trowels	591 - 593
Undercoat plasters	583
Universal One Coat plaster	584

W

Wafer Head Drywall Screws	540
Wafer Head Jack-Point Screws	541
Wall lining systems	240 - 289
WallBoard	512
WallBoard DUPLEX	514
WallBoard TEN	514
Warranty - see SpecSure®	

X

X-Ray plaster	583
---------------	-----



"Gyproc", "Thistle", "Gyframe" and "Glasroc" are all registered trademarks of BPB United Kingdom Limited. "Isover" is a registered trademark of Saint-Gobain Isover and "Artex" is a registered trademark of BPB United Kingdom Limited.

BPB United Kingdom Limited is a limited company registered in England under company number 734396, having its registered office at Saint-Gobain House, Binley Business Park, Coventry, CV3 2TT, UK. BPB United Kingdom Limited trades as British Gypsum for part of its business activities.

British Gypsum reserves the right to revise product specification without notice. The information herein should not be read in isolation as it is meant only as guidance for the user, who should always ensure that they are fully conversant with the products and systems being used and their subsequent installation prior to the commencement of work. For a comprehensive and up-to-date library of information visit the British Gypsum website at: www.british-gypsum.com. For information about products supplied by Artex Limited or Saint-Gobain Isover please see their respective websites.

"British Gypsum" is a registered trademark of BPB United Kingdom Limited.

Technical enquiries

British Gypsum

Technical Advice Centre

East Leake

Loughborough

Leicestershire

LE12 6HX

Telephone: 0844 800 1991

Fax: 0844 561 8816

Email: bgtechnical.enquiries@bpb.com

Training enquiries: 0844 561 8810

www.british-gypsum.com



EMS 543324 FM 52358

British Gypsum September 2013 SB-07-04